



EUROPEAN TECHNICAL ASSESSMENTS

**Fire Resistant Solutions for
Modular Support Systems**

MT System & Pipe clamps

Version 1.0

08.2023



Innovative and ETA-approved solutions for MEP supports under fire conditions

Worldwide fire events endanger human life, harm the environment and cause significant economic losses.

The overriding objective in terms of fire safety is to ultimately avoid fire events or in case they occur to minimize their consequences.

Fire design is crucial for buildings such as, hospitals, offices or hotels. These structures require escape routes. This is especially relevant for strategic and public buildings that have a large amount of people to be evacuated and often a low flow capacity. As a result, the correct design of the escape routes is essential to allow users to evacuate safely and for security teams to operate both during and after the fire.

Mechanical, Electrical and Plumbing (MEP) support systems are an integral part of the escape routes, and they need to remain structurally sound and operational for a fixed amount of time to enable safe passage of people during fire. It is important to have the correct fire design of every MEP support. The operation of the safety systems during a fire and the resistance of compartments can be damaged by the failure of these systems.

Hilti fire safe system serves the need of piping, ventilation and electrical systems from light to heavy applications. Hilti follows the state-of-the-art guideline, the European Assessment Document EAD-280016-00-062.







This method leads to cost-effective and flexible solution since fire resistant design can be applied for many installation configurations.





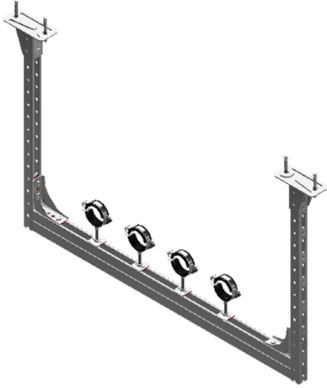

Through its extensive testing, Hilti provides European Technical Assessments ETAs with detailed technical documentation for load calculations, meeting the design needs of complex projects requiring customized solutions.

Hilti fire approved MT System provides solutions for the main relevant applications such as trapezes suspended by threaded rods, trapeze frames with horizontal and vertical channels, cantilevers without suspension, cantilevers suspended from ceiling with threaded rod, headrails and media connection to all above mentioned applications.

Support Systems design is crucial regarding compliance with fire safety objectives since significant deformations due to the exposure to fire can cause considerable damage.

To reduce time and cost involved to design fire resistant Support System and to achieve higher flexibility regarding construction variants, Hilti remains the partner with the best solution that can offer complex fire engineering design.

Configuration	System component	ETA number
<p>Rod trapeze</p>  	Threaded rod	ETA-22/0809
	Channel	ETA-23/0105
	Drilled plate	ETA-22/0810
	Pipe-clamp	Link to Pipe-clamps with ETA Fire
	Pipe-clamp saddle nut Pipe-clamp drilled plate	ETA-23/0103 ETA-22/0810
	Anchor	See Anchor ETAs
<p>Headrail</p>  	Threaded rod	ETA-22/0809
	Channel	ETA-23/0105
	Drilled plate	ETA-22/0810
	Pipe-clamp	Link to Pipe-clamps with ETA Fire
	Pipe-clamp saddle nut	ETA-23/0103
	Anchor	See Anchor ETAs
<p>Frame trapeze</p>  	Trapeze frame	ETA-23/0104
	Threaded rod	ETA-22/0809
	Pipe-clamp	Link to Pipe-clamps with ETA Fire
	Pipe-clamp saddle nut Pipe-clamp drilled plate	ETA-23/0103 ETA-22/0810
	Anchor	See Anchor ETAs

Configuration	System component	ETA number
<p>Single pipe-clamp</p>  	Threaded rod	ETA-22/0809
	Pipe-clamp	Link to Pipe-clamps with ETA Fire
	Anchor	See Anchor ETAs
<p>Suspended cantilever</p>  	Threaded rod	ETA-22/0809
	Bracket	ETA-23/0106
	Drilled plate	ETA-22/0810
	Pipe-clamp	Link to Pipe-clamps with ETA Fire
	Pipe-clamp saddle nut Pipe-clamp drilled plate	ETA-23/0103 ETA-22/0810
	Anchor	See Anchor ETAs
<p>Non-suspended cantilever</p>  	Threaded rod	ETA-22/0809
	Bracket	ETA-23/0106
	Pipe-clamp	Link to Pipe-clamps with ETA Fire
	Pipe-clamp saddle nut Pipe-clamp drilled plate	ETA-23/0103 ETA-22/0810
	Anchor	See Anchor ETAs



European Technical Assessment

ETA-23/0103 of 30/06/2023

English translation prepared by CSTB - Original version in French language

General Part

Technical Assessment Body issuing the European Technical Assessment:

Centre Scientifique et Technique du Bâtiment (CSTB)

Trade name of the construction product:	Hilti saddle nuts MQA-M10-B, MQA-M12-B, MQA-M16-B, MT-PCC-G M8 / M10 OC, MT-PCC-G M12 OC, MT-PCC-G M16 OC, MT-CTR-GS M12 OC, MT-CTR-GS M16 OC, MT-CTR-GL M12 OC, MT-CTR-GL M16 OC.
Product family to which the construction product belongs:	Products for installation systems for supporting technical building equipment
Manufacturer:	Hilti AG Feldkircherstraße 100 9494 Schaan FÜRSTENTUM LIECHTENSTEIN
Manufacturing plants:	L 1000446 and L1087643
This European Technical Assessment contains:	24 pages including 22 pages of annexes which form an integral part of this assessment
This European Technical Assessment is issued in accordance with Regulation (EU) No 305/2011, on the basis of:	European Assessment Document (EAD) 280016-00-0602 version June 2020
This Assessment replaces:	ETA-18/0132 of 25/07/2018

The European Technical Assessment is issued by the Technical Assessment Body in its official language. Translations of this European Technical Assessment in other languages shall fully correspond to the original issued document and shall be identified as such. Communication of this European Technical Assessment, including transmission by electronic means, shall be in full. However, partial reproduction may only be made with the written consent of the issuing Technical Assessment Body. Any partial reproduction shall be identified as such. This European Technical Assessment may be withdrawn by the issuing Technical Assessment Body, in particular pursuant to information by the Commission in accordance with Article 25(3) of Regulation (EU) No 305/2011.

Specific Part

1 Technical description of the product

Objects of this European Technical Assessment are the Hilti saddle nuts:

MQA-M10-B, MQA-M12-B and MQA-M16-B saddle nuts consist of a nut centred on a clamping plate made of steel, which are connected to one another by means of a spring element made of PET. The clamping plate have a centred round opening. The nut is used to fasten threaded elements, e.g. threaded rods.

MT-CTR-GS M12 OC, MT-CTR-GS M16 OC, MT-CTR-GL M12 OC and MT-CTR-GL M16 OC are kits with each kit consisting of a plate with a welded hexagon nut, a hexagon nut and washer, and one U-shaped steel plate with two vertical parallel legs with openings for fastening to the channels. The various distance between the legs allows the usage with Hilti channels MT-70, MT-80, MT-90 or MT-100 with Hilti connector MT-TFB. The upper horizontal part of the U-shaped steel plate has an opening to allow a threaded rod to pass through and to fasten it with the above-mentioned components of the kit.

MT-PCC-G M8/M10 OC, MT-PCC-G M12 OC and MT-PCC-G M16 OC are steel base plates with two long holes arranged symmetrically and with a centric arranged thread connection.

Annex A describes the dimensions and materials of above-mentioned Hilti saddle nuts.

2 Specification of the intended use

The performance given in Section 3 can only be assumed if the Hilti saddle nuts are used in compliance with the specifications and under boundary conditions set out in Annexes A to G. The test and assessment methods on which this European Technical Assessment is based lead to an assumption of a working life of the Hilti saddle nuts of at least 50 years in final use under ambient temperatures in indoor areas. The indications given on the working life cannot be interpreted as a guarantee given by the producer but are to be regarded only as a means for choosing the right products in relation to the expected economically reasonable working life of the works.

In accordance with the European Assessment Document EAD 280016-00-0602, the product is intended to be used in

- a) installations for the support of sprinkler kits,
- b) installations for the support of other building service elements such as pipes, conduits and ducts.

3 Performance of the product and references to the methods used for its assessment

3.1 Safety in case of fire (BWR 2)

No.	Essential characteristic	Performance
1	Reaction to fire	Class A2
2	Resistance under fire exposure for small channel deformations $\epsilon \leq 2\%$	See Annex D, G
3	Resistance under fire exposure for large channel deformations $\epsilon > 2\%$	See Annex E, G

3.2 Safety and accessibility in use (BWR 4)

No.	Essential characteristic	Performance
4	Shape	See Annex A
5	Dimensions	See Annex A
6	Material	See Annex A
7	Characteristic pull-out resistance	See Annex G

4 Assessment and verification of constancy of performance (AVCP) system applied, with reference to its legal base

In accordance with the European Assessment Document EAD 280016-00-0602, the following legal bases apply:

- In case of intended use a) specified in Section 2:
Decision of the commission N° 1996/577/EC as amended by Commission Decision 2002/592/EC.:
System 1 applies for the assessment and verification of constancy of performance (AVCP).
- In case of intended use b) specified in Section 2:
Decision of the commission N° 1999/472/EC as amended by Commission Decision 2001/596/EC.:
System 3 applies for the assessment and verification of constancy of performance (AVCP).

5 Technical details necessary for the implementation of the AVCP system, as provided for in the applicable EAD

The technical details necessary for the implementation of the system for the assessment and verification of constancy of performance are laid down in the control plan (confidential part of this European Technical Assessment) deposited at Centre Scientifique et Technique du Bâtiment.

The original French version is signed by

La cheffe de division, Anca CRONOPOL

Table A1: Dimensions and materials of Hilti MQA-B saddle nuts

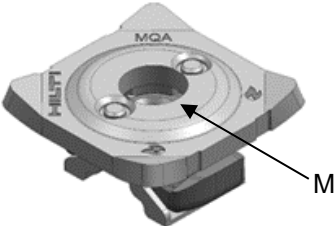
Item number	Designation	M thread	Materials	Illustration
2199452	MQA-M10-B	M10	Plate: DD11 according to DIN EN 10111 ¹⁾ or S235JR according to DIN EN 10025-2, zinc coated Nut: C4C according to DIN EN 10263-2 Plastic part: PET	
2199453	MQA-M12-B	M12		
2199454	MQA-M16-B	M16		

¹⁾ with $235 < R_{eL} < 340 \text{ N/mm}^2$, Deoxidization type: fully deoxidized

Table A2: Dimensions of the components of the MQA-M10-B and MQA-M12-B saddle nuts in mm

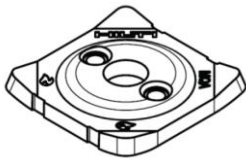
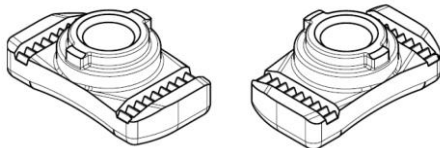
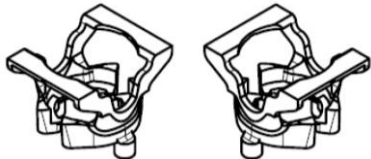
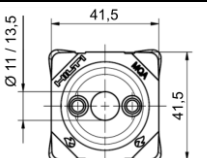
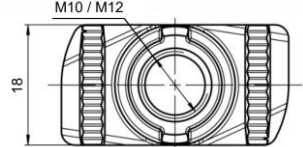
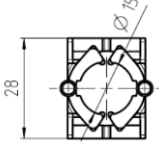
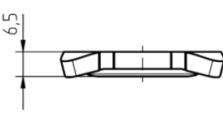
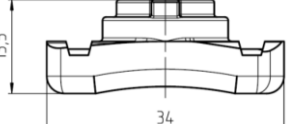
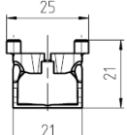
Plate	Nut	Spring section
		
		
		

Hilti saddle nuts product families MQA-B, MT-PCC-G and MT-CTR-GS

Product Description
 Dimensions and materials

Annex A1

Table A3: Dimensions of the components of the MQA-M16-B saddle nut in mm

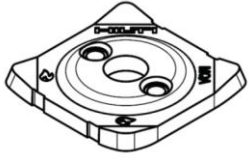
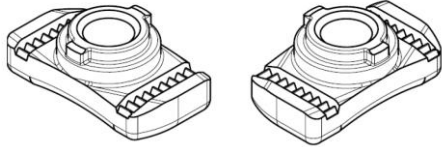
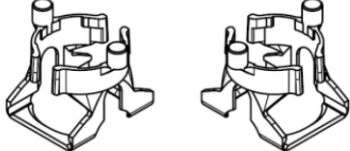
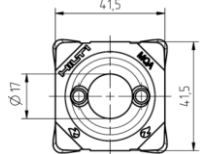
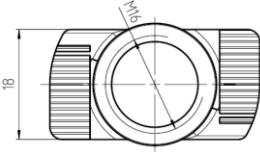
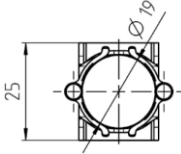
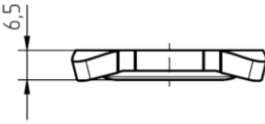
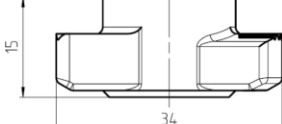
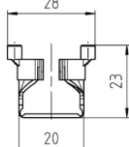
Plate	Nut	Spring section
		
		
		

Hilti saddle nuts product families MQA-B, MT-PCC-G and MT-CTR-GS

Product Description
 Dimensions and materials

Annex A2

Table A4: Dimensions and materials of the components of the MT-PCC-G saddle nut in mm

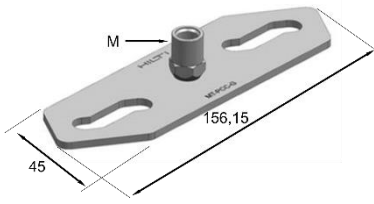
Item number	Designation	M thread	Baseplate thickness	Materials	Illustration (dimensions in mm)
2353801	MT-PCC-G M8/M10 OC	M10	4 mm	Baseplate: Q355B acc. to GB/T 1591, hot dipped galv. Connection piece: 9SMN28 acc. to DIN 1651, hot dipped galv.	
2354564	MT-PCC-G M12 OC	M12	4 mm		
2354155	MT-PCC-G M16 OC	M16	6 mm		

Hilti saddle nuts product families MQA-B, MT-PCC-G and MT-CTR-GS

Product Description
 Dimensions and materials

Annex A3

Table A5: Dimensions and materials of the components of the MT-CTR-G saddle nut in inches and mm

Item number	Designation	M thread	Materials	Illustration ¹⁾
2332789	MT-CTR-GS M12 OC	M12		
2332790	MT-CTR-GS M16 OC	M16	U-shape steel plate: Q355B acc. to GB/T 1591 Hot dipped galvanized Hexagonal Nut: Strength class 8 acc. to ISO898-2	
2332793	MT-CTR-GL M12 OC	M12	Washer 12/40 and 16/40 acc. to ISO 7089-200HV Plate: Q235B acc. to GB/T 700 Hot dipped galvanized	
2332796	MT-CTR-GL M16 OC	M16		

¹⁾ Threaded rod in illustration is not part of the item. The threaded rod is shown to illustrate how the parts of the items are combined.

Hilti saddle nuts product families MQA-B, MT-PCC-G and MT-CTR-GS

Product Description
 Dimensions and materials

Annex A4

- Hilti saddle nuts are used to transfer building services component loads such as ducts and equipment for sprinklers, water, heating, cooling, ventilation, electrical and other systems. Hilti saddle nuts are performing this loadbearing function under the conditions described in Section 2 of this European Technical Assessment.
- Hilti saddle nuts MQA-M10-B, MQA-M12-B and MQA-M16-B are performing this loadbearing function at ambient temperature and in case of fire in combination with Hilti MQ and MT open profile channels as listed in Annex B3 to Annex B7. Hilti saddle nuts MQA-M10-B, MQA-M12-B and MQA-M16-B are deployed for the fixation of threaded rods in installation systems in combination with hexagonal nuts. Hilti threaded rods of strength class ≥ 4.8 in accordance with DIN 976-1 as per Table B1 may be connected to saddle nuts MQA-M10-B, MQA-M12-B and MQA-M16-B and fixed with hexagonal nuts of strength class ≥ 8 in accordance with ISO 4032 as per Table B2.
- The channels are cut to desired length centrally between the slotted- or round-holes or the round-holes on the marking. The channel may be cut within a range of 2 mm from both sides of the marking.

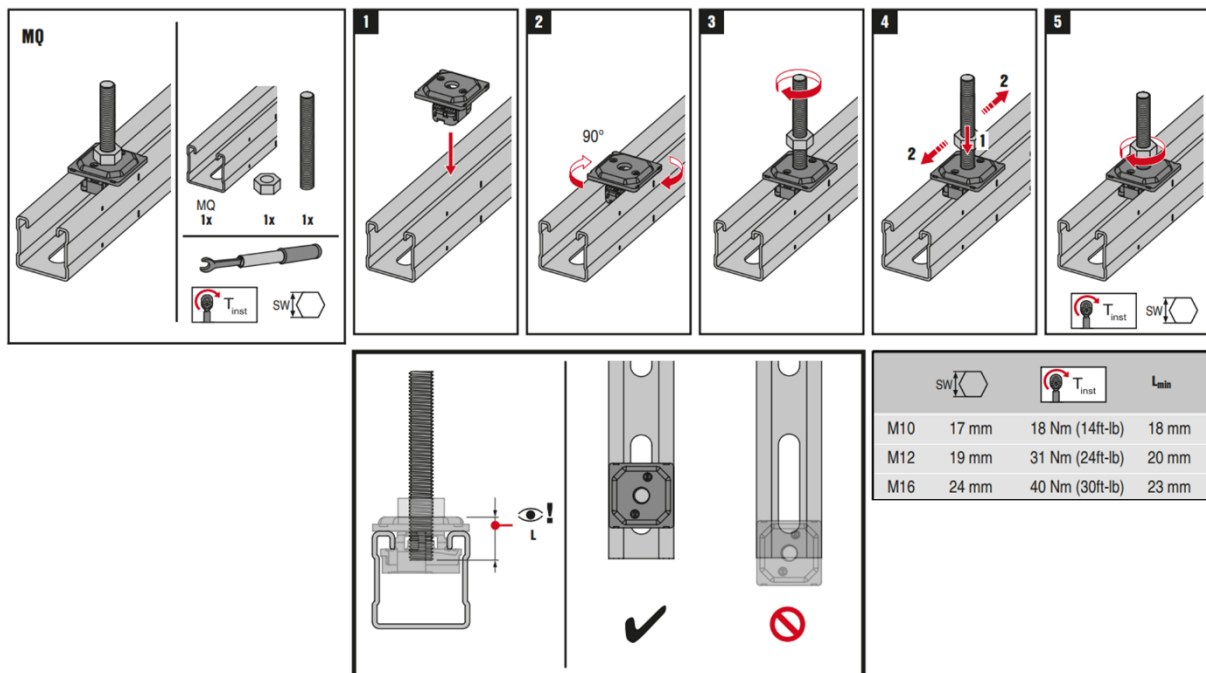

Figure A1: Installation instructions of the MQA-B saddle nut in conjunction with channel, hex-nut and threaded rod.

- Hilti saddle nuts MT-CTR-GS M12 OC and MT-CTR-GS M16 OC are used for suspending Hilti channels MT-70 or MT-80 using two Hilti thread forming bolt MT-TFB OC, see Figure A2 (left).
- Hilti saddle nuts MT-CTR-GL M12 OC and MT-CTR-GL M16 OC are used for suspending Hilti channels MT-80, MT-90 or MT-100 using two Hilti thread forming bolt MT-TFB OC, see Figure A2 (right).

Hilti saddle nuts product families MQA-B, MT-PCC-G and MT-CTR-GS

Requirements for performance assessment

Annex A5

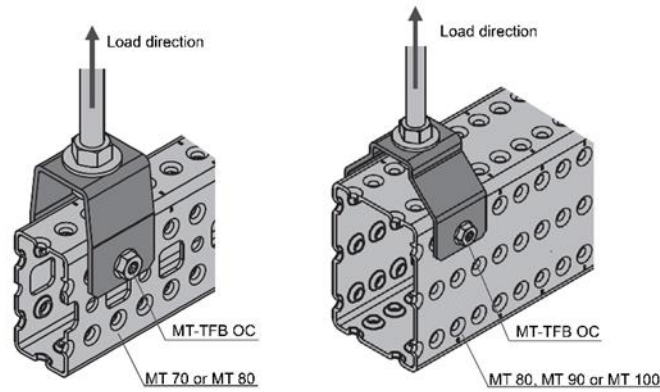

Figure A2: Assembly of Hilti MT-CTR saddle nut with Hilti MT channel

- The Hilti MT-PCC-G M8/M10 OC, MT-PCC-G M12 OC and MT-PCC-G M16 OC saddle nuts are used in combination with Hilti channels MT-70, MT-80, MT-90 or MT-100. Both items are connected with two Hilti thread forming bolt MT-TFB OC, see figure A3.

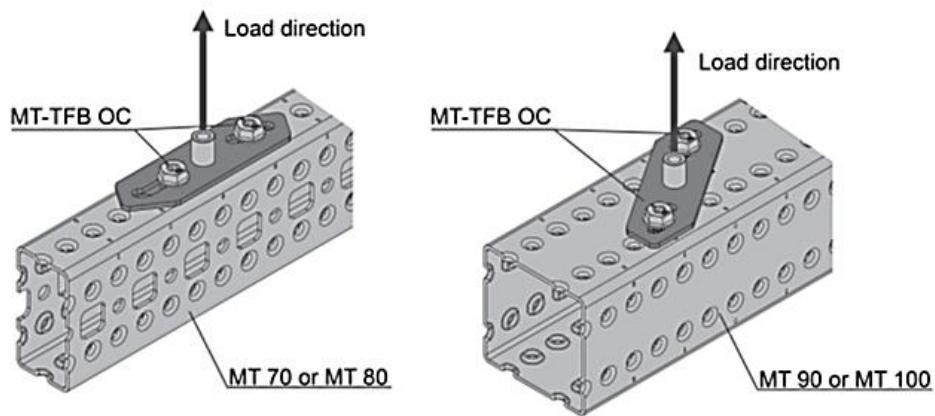

Figure A3: Assembly of Hilti MT-PCC-G saddle nut with Hilti MT channel

- MT-TFB OC thread forming bolts are positioned through the appropriate openings of these components. For the bolt MT-TFB OC a torque of 60 Nm applies.
- The required torques of Hilti saddle nuts may be applied with electrical devices or with a torque wrench.
- The saddle nuts must be installed by appropriately qualified personnel and under the supervision of the site manager. The installation instruction of the manufacturer applies.
- Information on resistance at ambient temperature and in case of fire applies to static and centric actions. The time values in conjunction with the resistance values at elevated temperatures refer to the boundary conditions of the standard Temperature / Time curve (STTC) according to EN 1363-1.
- Prior to installation, it must be ensured that the supported component, the anchoring of the threaded rod to the base material and the base material itself are suitable to withstand the resistance values of the installation system and that they have a fireproof certificate.

Hilti saddle nuts product families MQA-B, MT-PCC-G and MT-CTR-GS

Requirements for performance assessment

Annex A6

Table B1: Dimensions and materials of Hilti threaded rods for use with Hilti saddle nuts

Item number	Designation	M thread	L [mm]	Materials	Illustration
339795	AM10x1000 4.8	M10	1000	Strength class 4.8 in accordance with DIN976-1, zinc coated	
339796	AM10x2000 4.8	M10	2000		
216418	AM10x3000 4.8	M10	3000		
339797	AM12x1000 4.8	M12	1000		
216420	AM12x2000 4.8	M12	2000		
216421	AM12x3000 4.8	M12	3000		
216422	AM16x1000 4.8	M16	1000		
216423	AM16x2000 4.8	M16	2000		
216424	AM16x3000 4.8	M16	3000		
407497	AM 8.8 M10x1000	M10	1000	Strength class 8.8 in accordance with DIN976-1, zinc coated	
2008566	AM 8.8 M10x3000	M10	3000		
407498	AM 8.8 M12x1000	M12	1000		
2008567	AM 8.8 M12x3000	M12	3000		
407499	AM 8.8 M16x1000	M16	1000		
2008568	AM 8.8 M16x3000	M16	3000		
58670	AM10x1000 A4-70	M10	1000	Strength class A4-70 in accordance with DIN976-1, Stainless steel	
58707	AM10x3000 A4-70	M10	3000		
58671	AM12x1000 A4-70	M12	1000		
58709	AM12x3000 A4-70	M12	3000		
58683	AM16x1000 A4-70	M16	1000		
58712	AM16x3000 A4-70	M16	3000		

Hilti saddle nuts product families MQA-B, MT-PCC-G and MT-CTR-GS

Product description
 Dimensions and materials

Annex B1

Table B2: Dimensions and materials of Hilti hexagonal nuts for use with Hilti saddle nuts

Illustration	Item number	Designation	M thread	W [mm]	H [mm]	Material
	216466	M10 hexagonal nut	M10	17	8	Strength class 8 in accordance with DIN 934, zinc coated
	2184554	M12 hexagonal nut	M12	19	10	
	2184506	M16 hexagonal nut	M16	24	13	
	2184474	M10 hexagonal nut	M10	17	8	Strength class 70 in accordance with DIN 934, stainless steel
	2184475	M12 hexagonal nut	M12	19	10	
	2184476	M16 hexagonal nut	M16	24	13	

Table B3: Dimensions and materials of Hilti MT-TFB OC thread forming bolt

Item number	Designation	Materials and coatings	Illustration (Dimensions in mm)
2272084	MT-TFB OC	C10B21 acc. to SAE J403, Surface hardness min. 530 HV, Core hardness min. 32-39 HRC zinc coated with organic topcoat	

Hilti saddle nuts product families MQA-B, MT-PCC-G and MT-CTR-GS

Product description
 Dimensions and materials

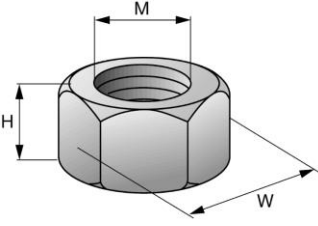
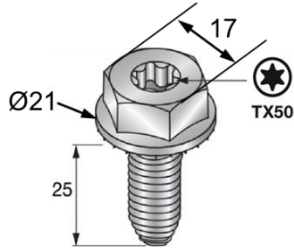
Annex B2

Table B4: Dimensions and materials of Hilti MQ-41/3 3M, MQ-41/3 6M, MQ-41/3 3M LL, MQ-41/3 6M LL, MQ-41 D 3M and MQ-41 D 6M installation channels for use with Hilti MQA-B saddle nuts

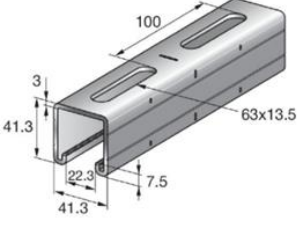
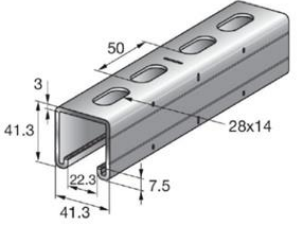
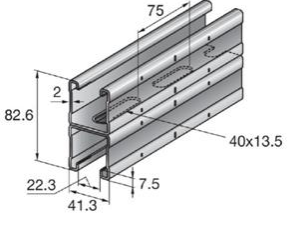
Illustration ²⁾	Item number	Designation	Materials and coatings
	369596	MQ-41/3 3M	S250GD+Z275-M-A-C according to DIN EN 10346
	369597	MQ-41/3 6M	
	2048102	MQ-41/3 3M LL	S250GD+Z275-M-A-C according to DIN EN 10346
	2048103	MQ-41/3 6M LL	
 <p data-bbox="164 1198 614 1377">Two profiles of MQ-41 D channel are connected in the area of the slotted or round holes in the back of the channels in a shape-fitting and force-fitting way as a kind of riveted connection.</p>	369603	MQ-41 D 3m	S250GD+Z275-M-A-C according to DIN EN 10346
	369604	MQ-41 D 6m	

²⁾ Dimensions in mm

<p>Hilti saddle nuts product families MQA-B, MT-PCC-G and MT-CTR-GS</p>	<p>Annex B3</p>
<p>Product description Dimensions and materials</p>	

Table B5: Dimensions and materials of Hilti MQ-21.5 6m, MQ-21.5 3m, MQ-21.5 2m, MQ-41 6m, MQ-41 3m, MQ-41 2m, MQ-41-L 6m, MQ-41-L 3m and MQ-41-L 2m installation channels for use with Hilti MQA-B saddle nuts

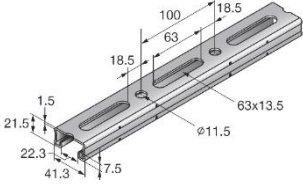
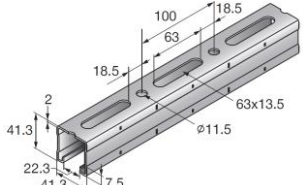
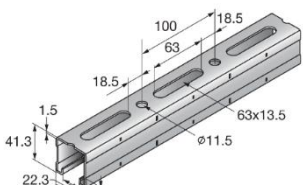
Figure ³⁾	Item number	Designation	Materials and coatings
	2184773	MQ-21.5 6m	S280GD+Z140-M-A-C according to DIN EN 10346
	2184772	MQ-21.5 3m	
	2184771	MQ-21.5 2m	
	369592	MQ-41 6m	S250GD+Z275-M-A-C according to DIN EN 10346
	369591	MQ-41 3m	
	304559	MQ-41 2m	
	2141964	MQ-41-L 6m	S250GD+Z140-M-A-C according to DIN EN 10346
	2141965	MQ-41-L 3m	
	2141966	MQ-41-L 2m	

³⁾ Dimensions in mm

Hilti saddle nuts product families MQA-B, MT-PCC-G and MT-CTR-GS

Product description
 Dimensions and materials

Annex B4

Table B6: Dimensions and materials of Hilti MT-30 S, MT-30, MT-30 S OC, MT-30 OC, MT-40 S, MT-40, MT-40 S OC and MT-40 OC installation channels for use with Hilti MQA-B saddle nuts

Figure ⁴⁾	Item number	Designation	Length [m]	Materials and coatings
	2268497	MT-30 S	3	S280GD or equivalent as defined in HN704 + Z275-M-A-C acc. to EN 10346
	2268498	MT-30	6	
	2268499	MT-30 S OC	3	S280GD or equivalent as defined in HN704 + ZM310-A-C acc. to EN 10346
	2268500	MT-30 OC	6	
	2268505	MT-40 S	3	S280GD or equivalent as defined in HN704 + Z275-M-A-C acc. to EN 10346
	2268506	MT-40	6	
	2268507	MT-40 S OC	3	S280GD or equivalent as defined in HN704 + ZM310-A-C acc. to EN 10346
	2268508	MT-40 OC	6	

⁴⁾ Dimensions in inches and mm

Hilti saddle nuts product families MQA-B, MT-PCC-G and MT-CTR-GS

Product description
 Dimensions and materials

Annex B5

Table B7: Dimensions and materials of Hilti MT-50 S, MT-50, MT-50 S OC, MT-50 OC, MT-40D S, MT-40D, MT-40D S OC, MT-40D OC installation channels for use with Hilti MQA-B saddle nuts

Figure ⁵⁾	Item number	Designation	Length [m]	Materials and coatings
	2268509	MT-50 S	3	S280GD or equivalent as defined in HN704 + Z275-M-A-C acc. to EN 10346
	2268510	MT-50	6	
	2268511	MT-50 S OC	3	S280GD or equivalent as defined in HN704 + ZM310-A-C acc to. EN 10346
	2268512	MT-50 OC	6	
<p>Two profiles of MT-40 channel are connected in the area of the slotted or round holes in the back of the channels in a shape-fitting and force-fitting way as a kind of riveted connection.</p>	2268517	MT-40D S	3	S280GD or equivalent as defined in HN704 + Z275-M-A-C acc. to EN 10346
	2268518	MT-40D	6	
<p>Two profiles of MT-40 OC channel are connected in the area of the slotted or round holes in the back of the channels in a shape-fitting and force-fitting way as a kind of riveted connection.</p>	2268519	MT-40D S OC	3	S280GD or equivalent as defined in HN704 + ZM310-A-C acc to. EN 10346
	2268520	MT-40D OC	6	

⁵⁾ Dimensions in inches and mm

Hilti saddle nuts product families MQA-B, MT-PCC-G and MT-CTR-GS		Annex B6
Product description Dimensions and materials		

Table B8: Dimensions and materials of Hilti MT-70 S OC, MT-70 OC, MT-80 S OC, MT-80 OC installation channels for use with Hilti MT-PCC-C, MT-CTR-GS and MT-CTR-GL saddle nuts

Figure ⁶⁾	Item number	Designation	Length [m]	Materials and coatings
	2268364	MT-70 S OC	3	S350GD+ ZM310-A-C acc. to EN 10346
	2268365	MT-70 OC	6	
	2268366	MT-80 S OC	3	S350GD+ ZM310-A-C acc. to EN 10346
	2268367	MT-80 OC	6	
	2268368	MT-90 S OC	3	S350GD+ ZM310-A-C acc. to EN 10346
	2268369	MT-90 OC	6	
	2268490	MT-100 S OC	3	S350GD+ ZM310-A-C acc. to EN 10346
	2268491	MT-100 OC	6	

⁶⁾ Dimensions in inches and mm

Hilti saddle nuts product families MQA-B, MT-PCC-G and MT-CTR-GS

Product description
 Dimensions and materials

Annex B7

Table C1: Characteristic pull-out resistance at ambient temperatures of Hilti MQA-B saddle nuts

Pipe ring saddle	Installation channel	Characteristic pull-out resistance
		F _{Rk} [kN]
MQA-M10-B	MQ-41/3	23.26
	MQ-41/3 LL	
	MQ-41	15.08
	MQ-41 D	
	MQ-41-L	
	MQ-21.5	
MQA-M12-B	MQ-41/3	20.63
	MQ-41/3 LL	
	MQ-41	15.92
	MQ-41 D	
	MQ-41-L	
	MQ-21.5	
MQA-M16-B	MQ-41/3	21.70
	MQ-41/3 LL	
	MQ-41	11.79
	MQ-41 D	
	MQ-41-L	
	MQ-21.5	
MQA-M10-B MQA-M12-B MQA-M16-B	MT-30 MT-30 OC MT-40 MT-40 S MT-40 S OC MT-40 OC MT-40D MT-40D S MT-40D OC MT-50 MT-50 S MT-50 S OC MT-50 OC	NPA ⁷⁾

⁷⁾ NPA: No performance assessed

All characteristic resistances for ambient temperatures do not consider deflections.

Partial safety factor for design resistance is $\gamma_M = F_{Rk} / F_{Rd}$ or $\gamma_M = M_{Rk} / M_{Rd}$.

For design resistances the manufacturer's specifications and national regulations must be observed.

Hilti saddle nuts product families MQA-B, MT-PCC-G and MT-CTR-GS

Characteristic pull-out resistance of MQA-B at ambient temperatures

Annex C1

Table D1: Parameter of regression curve $F_{Rk,t} = c_3 (c_1 + c_2 / t)$ for $\epsilon_{B,9a} \leq 2 \%$ of Hilti MQA-B saddle nuts

Designation	Installation channel	c_1	c_2	c_3	t_{min} [min]	t_{max} [min]
MQA-M10-B MQA-M12-B	MQ-41/3	695,324	27657,410	0,704	20	150
	MQ-41/3 LL					
	MQ-41	345,949	28750,936	0,713	20	120
	MQ-41D					
	MQ-41-L	-462,03	35853,38	0,8808	30	33
	MQ-21.5	110,27	19232,88	0,9786	30	48
	MT-30 ⁸⁾	270,9122	21855,373	0,797211	22	130
	MT-40 ⁹⁾					
	MT-40D ⁸⁾					
	MT-50 ⁹⁾	449,2781	33887,6065	0,845128	29	131
MQA-M16-B	MQ-41/3	758,416	38174,329	0,844	26	130
	MQ-41/3 LL					
	MQ-41	345,949	28750,936	0,713	26	120
	MQ-41D					
	MQ-41-L	-462,03	35853,38	0,8808	30	33
	MQ-21.5	110,27	19232,88	0,9786	30	48
	MT-30 ⁸⁾	16,1699	26899,3433	0,723396	24	150
	MT-40 ⁹⁾					
	MT-40D ⁸⁾					
	MT-50 ⁹⁾	326,9387	36881,5484	0,949819	41	130

⁸⁾ independent of production length and coating

⁹⁾ independent of production length, coating and presence of slotted or round holes

Designation

$F_{Rk,t}$ Resistance after an exposure time t in case of fire [N]

Hilti saddle nuts product families MQA-B, MT-PCC-G and MT-CTR-GS

Parameter of pull-out regression curve of MQA-B for $\epsilon_{B,9a} \leq 2 \%$ in case of fire

Annex D1

Table D2: Pull-out resistance $F_{Rk,t}$ in case of fire after $t = 30, 60, 90$ and 120 minutes and $\epsilon_{B,\theta a} \leq 2\%$ of Hilti MQA-B saddle nuts

Designation	Installation channel	$F_{Rk,30}$ [N]	$F_{Rk,60}$ [N]	$F_{Rk,90}$ [N]	$F_{Rk,120}$ [N]
MQA-M10-B MQA-M12-B	MQ-41/3	1138	813	705	651
	MQ-41/3 LL				
	MQ-41	930	589	475	NPA ¹⁰⁾
	MQ-41D				
	MQ-41-L	646	NPA	NPA	NPA
	MQ-21.5	735	NPA	NPA	NPA
	MT-30 ¹¹⁾	796,7	506,4	409,6	361,2
	MT-40 ¹²⁾				
	MT-40D ¹¹⁾				
	MT-50 ¹²⁾	1334,3	857	697,9	618,4
MQA-M16-B	MQ-41/3	1710	1176	998	909
	MQ-41/3 LL				
	MQ-41	930	589	475	NPA
	MQ-41D				
	MQ-41-L	646	NPA	NPA	NPA
	MQ-21.5	735	NPA	NPA	NPA
	MT-30 ¹¹⁾	660,3	336,0	227,9	173,9
	MT-40 ¹²⁾				
	MT-40D ¹¹⁾				
	MT-50 ¹²⁾	1478,2	894,4	699,8	602,5

¹⁰⁾ NPA: No performance assessed

¹¹⁾ independent of production length and coating

¹²⁾ independent of production length, coating and presence of slotted or round holes

Designation

$F_{Rk,t}$ Resistance after an exposure time t in case of fire [N]

Hilti saddle nuts product families MQA-B, MT-PCC-G and MT-CTR-GS

Pull-out resistance of MQA-B for $\epsilon_{B,\theta a} \leq 2\%$ in case of fire

Annex D2

Table E2: Parameter of regression curve $F_{Rk,t} = c_3 (c_1 + c_2 / t)$ for $\epsilon_{B,0a} > 2\%$ of Hilti MQA-B saddle nuts

Designation	Installation channel	C ₁	C ₂	C ₃	t _{min} [min]	t _{max} [min]
MQA-M10-B	MQ-41/3	445,338	18381,52	0,917	26	130
	MQ-41/3 LL					
MQA-M12-B	MQ-41/3	434,765	24088,663	0,872	26	123
	MQ-41/3 LL					
MQA-M10-B MQA-M12-B	MQ-41	255,989	15310,519	0,865	22	120
	MQ-41D					
	MQ-41-L	102,97	16294,33	0,9344	21	60
	MQ-21.5	406,83	11709,31	0,9900	33	49
	MT-30 ¹³⁾	39,8267	29669,8577	0,730085	23	130
	MT-40 ¹⁴⁾					
	MT-40D ¹³⁾					
MT-50 ¹⁴⁾	516,5954	21842,9458	0,739941	17	150	
MQA-M16-B	MQ-41/3	434,382	19535,05	0,907	22	139
	MQ-41/3 LL					
	MQ-41	255,989	15310,519	0,865	22	120
	MQ-41D					
	MQ-41-L	NPA ¹⁵⁾	NPA	NPA	NPA	NPA
	MQ-21.5	NPA	NPA	NPA	NPA	NPA
	MT-30 ¹³⁾	-246,8885	34576,4287	0,440543	25	123
	MT-40 ¹⁴⁾					
	MT-40D ¹³⁾					
MT-50 ¹⁴⁾	333,7164	18570,4336	0,712119	19	114	

¹³⁾ independent of production length and coating

¹⁴⁾ independent of production length, coating and presence of slotted or round holes

¹⁵⁾ NPA: No performance assessed

Designation

F_{Rk,t} Resistance after an exposure time t in case of fire [N]

Hilti saddle nuts product families MQA-B, MT-PCC-G and MT-CTR-GS

Parameter of pull-out regression curve of MQA-B for $\epsilon_{B,0a} > 2\%$ in case of fire

Annex E1

Table E1: Pull-out resistance $F_{Rk,t}$ in case of fire after $t = 30, 60, 90$ and 120 minutes and $\epsilon_{B,\theta a} > 2\%$ of Hilti MQA-B saddle nuts

Designation	Installation channel	$F_{Rk,30}$ [N]	$F_{Rk,60}$ [N]	$F_{Rk,90}$ [N]	$F_{Rk,120}$ [N]
MQA-M10-B	MQ-41/3	970	689	595	549
	MQ-41/3 LL				
MQA-M12-B	MQ-41/3	1080	729	613	554
	MQ-41/3 LL				
MQA-M10-B MQA-M12-B	MQ-41	663	442	369	NPA ¹⁸⁾
	MQ-41D				
	MQ-41-L	646	NPA	NPA	NPA
	MQ-21.5	735	NPA	NPA	NPA
	MT-30 ¹⁶⁾	751,1	390,1	269,8	209,6
	MT-40 ¹⁷⁾				
	MT-40D ¹⁶⁾				
MT-50 ¹⁷⁾	921	651,6	561,8	516,9	
MQA-M16-B	MQ-41/3	984	689	590	541
	MQ-41/3 LL				
	MQ-41	663	442	369	NPA
	MQ-41D				
	MQ-41-L	NPA	NPA	NPA	NPA
	MQ-21.5	NPA	NPA	NPA	NPA
	MT-30 ¹⁶⁾	399	145,1	60,5	NPA
	MT-40 ¹⁷⁾				
	MT-40D ¹⁶⁾				
	MT-50 ¹⁷⁾	678,5	458,1	384,6	NPA

¹⁶⁾ independent of production length and coating

¹⁷⁾ independent of production length, coating and presence of slotted or round holes

¹⁸⁾ NPA: No performance assessed

Designation

$F_{Rk,t}$ Resistance after an exposure time t in case of fire [N]

Hilti saddle nuts product families MQA-B, MT-PCC-G and MT-CTR-GS

Pull-out resistance of MQA-B for $\epsilon_{B,\theta a} > 2\%$ in case of fire

Annex E2

Table F1: Resistance $F_{Rk,t}$ of Hilti MT-CTR-GS M12 OC and MT-CTR-GS M16 OC saddle nuts in case of fire after $t = 30, 60, 90$ and 120 minutes in combination with threaded rod strength class ≥ 8.8

Designation	Installation channel	$F_{Rk,30}$ [N]	$F_{Rk,60}$ [N]	$F_{Rk,90}$ [N]	$F_{Rk,120}$ [N]
MT-CTR-GS M12 OC	MT-70 OC / S OC	4015,3	2117,5	1484,8	1168,5
	MT-80 OC / S OC				
MT-CTR-GS M16 OC	MT-70 OC / S OC				
	MT-80 OC / S OC				
MT-CTR-GL M12 OC	MT-70 OC / S OC	NPA ¹⁹⁾	NPA	NPA	NPA
	MT-80 OC / S OC				
MT-CTR-GL M12 OC	MT-70 OC / S OC	NPA	NPA	NPA	NPA
	MT-80 OC / S OC				

¹⁹⁾ NPA: No performance assessed

Designation

$F_{Rk,t}$ Resistance after an exposure time t in case of fire [N]

Hilti saddle nuts product families MQA-B, MT-PCC-G and MT-CTR-GS

Pull-out resistance of MT-CTR-GS in case of fire in combination with threaded rod strength class ≥ 8.8

Annex F1

Table G1: Characteristic resistance of Hilti MT-PCC-G M8/M10 OC, MT-PCC-G M12 OC, MT-PCC-G M16 saddle nuts at ambient temperature

Designation	Threaded rod	Installation channel	Characteristic resistance $F_{z,Rk}$ in kN
MT-PCC-G M8/M10 OC	M8	MT-70 S OC, MT-70 OC,	15.87
	M10	MT-80 S OC, MT-80 OC	26.03
MT-PCC-G M12 OC	M12	MT-90 S OC, MT-90 OC,	26.20
MT-PCC-G M16 OC	M16	MT-100 S OC, MT-100 OC	21.55

Designation

$F_{z,Rk}$ Resistance in direction of local z-Axis

All characteristic resistances for ambient temperatures do not consider deflections.

Partial safety factor for design resistance is $\gamma_M = F_{Rk} / F_{Rd}$ or $\gamma_M = M_{Rk} / M_{Rd}$.

For design resistances the manufacturer's specifications and national regulations must be observed.

Hilti saddle nuts product families MQA-B, MT-PCC-G and MT-CTR-GS

Pull-out resistance of MT-PCC-G at ambient temperature

Annex G1

Table G2: Pull-out resistance $F_{Rk,t}$ in case of fire after $t = 30, 60, 90$ and 120 minutes for small and large channel deformations and inclination between 0° and 45° in combination with threaded rod strength class ≥ 4.8

Designation	Installation channel	$F_{Rk,30}$ [N]	$F_{Rk,60}$ [N]	$F_{Rk,90}$ [N]	$F_{Rk,120}$ [N]
MT-PCC-G M8 / M10 OC	MT-70 OC / S OC	NPA ²⁰	NPA	NPA	NPA
	MT-80 OC / S OC				
MT-PCC-G M12 OC MT-PCC-G M16 OC	MT-70 OC / S OC	1740,7	1187,7	1003,3	911,2
	MT-80 OC / S OC				

²⁰) NPA: No performance assessed

Designation

$F_{Rk,t}$ Resistance after an exposure time t in case of fire [N]

Hilti saddle nuts product families MQA-B, MT-PCC-G and MT-CTR-GS

Pull-out resistance of MT-PCC-G in case of fire for small and large channel deformations and inclination between 0° and 45° in combination with threaded rod strength class ≥ 4.8

Annex G2

European Technical Assessment

ETA-22/0809 of 02/01/2023

English translation prepared by CSTB - Original version in French language

General Part

Trade name:	AM10 x L 4.8, AM12 x L 4.8, AM16 x L 4.8 threaded rods AM10 x L 8.8, AM12 x L 8.8, AM16 x L 8.8 threaded rods AM10 x L A4-70, AM12 x L A4-70, AM16 x L A4-70 threaded rods
Product family:	Products for installation systems for supporting technical building equipment
Manufacturer:	Hilti AG Liechtenstein Feldkircherstraße 100 9494 Schaan FÜRSTENTUM LIECHTENSTEIN
Manufacturing plants:	L 9295
This European Technical Assessment contains:	17 pages including 15 pages of annexes which form an integral part of this assessment
This European Technical Assessment is issued in accordance with Regulation (EU) No 305/2011, on the basis of:	European Assessment Document (EAD) 280016-00-0602 version August 2017
This version replaces:	ETA-18/0131 of 9 July 2018

The European Technical Assessment is issued by the Technical Assessment Body in its official language. Translations of this European Technical Assessment in other languages shall fully correspond to the original issued document and shall be identified as such. Communication of this European Technical Assessment, including transmission by electronic means, shall be in full. However, partial reproduction may only be made with the written consent of the issuing Technical Assessment Body. Any partial reproduction shall be identified as such. This European Technical Assessment may be withdrawn by the issuing Technical Assessment Body, in particular pursuant to information by the Commission in accordance with Article 25(3) of Regulation (EU) No 305/2011.

Specific Part

1 Technical description of the product

Objects of this European Technical Assessment are the Hilti threaded rods AM10 x L, AM12 x L and AM16 x L in strength class 4.8, 8.8 and A4-70. The threaded rods are made of steel with metric threads M10, M12 and M16. They are delivered in lengths of 1m, 2m and 3m and are cut to length as required.

Annex A describes the dimensions and materials of the Hilti threaded rods AM10 x L, AM12 x L and AM16 x L in strength class 4.8, 8.8 and A4-70.

Information on the intended use and the requirements for the performance assessment are given in Annex B.

2 Specification of the intended use

The performance given in Section 3 can only be assumed if the Hilti threaded rods AM10 x L, AM12 x L and AM16 x L in strength class 4.8, 8.8 and A4-70 is used in compliance with the specifications and under boundary conditions set out in Annexes A to D. The test and assessment methods on which this European Technical Assessment is based lead to an assumption of a working life of the Hilti threaded rods AM10 x L, AM12 x L and AM16 x L in strength class 4.8, 8.8 and A4-70 of at least 50 years in final use under ambient temperatures in indoor areas. The indications given on the working life cannot be interpreted as a guarantee given by the producer but are to be regarded only as a means for choosing the right products in relation to the expected economically reasonable working life of the works.

In accordance with the European Assessment Document EAD 280016-00-0602, the product is intended to be used in

- a) installations for the support of sprinkler kits,
- b) installations for the support of other building service elements such as pipes, conduits, ducts and cables.

3 Performance of the product and references to the methods used for its assessment

3.1 Safety in case of fire (BWR 2)

Essential characteristic	Performance
Reaction to fire	Class A1
Resistance to combined bending and tension under fire exposure	See Annex C
Tension resistance under fire exposure	See Annex D
Compression resistance under fire exposure	See Annex D

3.2 Safety and accessibility in use (BWR 4)

Essential characteristic	Performance
Dimensions	See Annex A1
Material	See Annex A1

4 Assessment and verification of constancy of performance (AVCP) system applied, with reference to its legal base

In accordance with the European Assessment Document EAD 280016-00-0602, the following legal bases apply:

- In case of intended use a) specified in Section 2:
Decision of the commission N° 1996/577/EC as amended by Commission Decision 2002/592/EC.:

System 1 applies for the assessment and verification of constancy of performance (AVCP).

- In case of intended use b) specified in Section 2:
Decision of the commission N° 1999/472/EC as amended by Commission Decision 2001/596/EC.:

System 3 applies for the assessment and verification of constancy of performance (AVCP).

5 Technical details necessary for the implementation of the AVCP system, as provided for in the applicable EAD

The technical details necessary for the implementation of the system for the assessment and verification of constancy of performance are laid down in the control plan (confidential part of this European Technical Assessment) deposited at Centre Scientifique et Technique du Bâtiment.

The manufacturer shall, on the basis of a contract, involve a notified body approved in the field of supporting systems for issuing the certificate of conformity CE based on the control plan.

The original French version is signed by

La cheffe de division, Anca CRONOPOL

Figure A1: Dimensions and materials of Hilti threaded rods

Item number	Designation	M thread	L [mm]	Materials	Illustration
339795	AM10x1000 4.8	M10	1000	Strength class 4.8 in accordance with DIN976-1, zinc coated	
339796	AM10x2000 4.8	M10	2000		
216418	AM10x3000 4.8	M10	3000		
339797	AM12x1000 4.8	M12	1000		
216420	AM12x2000 4.8	M12	2000		
216421	AM12x3000 4.8	M12	3000		
216422	AM16x1000 4.8	M16	1000		
216423	AM16x2000 4.8	M16	2000		
216424	AM16x3000 4.8	M16	3000		
407497	AM 8.8 M10x1000	M10	1000		
2008566	AM 8.8 M10x3000	M10	3000		
407498	AM 8.8 M12x1000	M12	1000		
2008567	AM 8.8 M12x3000	M12	3000		
407499	AM 8.8 M16x1000	M16	1000		
2008568	AM 8.8 M16x3000	M16	3000		
58670	AM10x1000 A4-70	M10	1000	Strength class A4-70 in accordance with DIN976-1, Stainless steel	
58707	AM10x3000 A4-70	M10	3000		
58671	AM12x1000 A4-70	M12	1000		
58709	AM12x3000 A4-70	M12	3000		
58683	AM16x1000 A4-70	M16	1000		
58712	AM16x3000 A4-70	M16	3000		

Hilti threaded rods AM10, AM12 and AM16 x L strength class 4.8, 8.8 and A4-70

Product Description
 Dimensions and materials

Annex A1

- Hilti threaded rods AM10 x L 4.8, AM12 x L 4.8 und AM16 x L 4.8 are used to transfer building services component loads such as ducts and equipment for sprinklers, water, heating, cooling, ventilation, electrical and other systems. Hilti threaded rods AM10 x L 4.8, AM12 x L 4.8 und AM16 x L 4.8 are performing this loadbearing function at elevated temperatures under the conditions described in Section 2 of this European Technical Assessment.
- Hilti threaded rods AM10 x L 4.8, AM12 x L 4.8 und AM16 x L 4.8 are deployed as thread connectors in installation systems. Typical examples for the application of threaded rods in installation systems are:
 - for suspending or mounting pipe clamps in conjunction with installation channels;
 - for suspending installation channels.
- If such systems are exposed to elevated temperatures, threaded rods are exposed to combined bending and tension stress as a result of a link polygon forming between the suspension points and the channel. The combined bending and tension resistance at elevated temperatures results with a cantilever arm length of threaded rod ≤ 150 mm. Installed horizontally in a furnace, the threaded rod is rigidly connected to a vertical channel and loaded at its outer end (see Figure B1).
- The resistance in case of fire applies for static and centric actions.
- The anchoring used with the base material must be suitable and have a fireproof certificate.
- Prior to installation, it must be ensured that the supported component, the anchoring of the threaded rod to the base material and the base material itself are suitable to withstand the resistance values of the installation system and that they have a fireproof certificate.
- The threaded rods must be installed by appropriately qualified personnel and under the supervision of the site manager

Figure B1: Installed threaded rod in conjunction with vertical channel

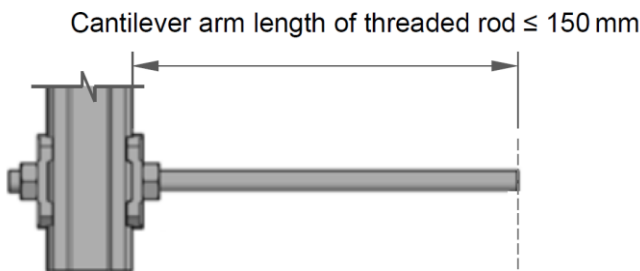

Hilti threaded rods AM10, AM12 and AM16 x L strength class 4.8, 8.8 and A4-70

Requirements for performance assessment

Annex B1

Table C1: Resistance to combined bending and tension load in case of fire: Parameter of regression curve $F_{Rk,t} = c_3 (c_1 + c_2 / t)$ of Hilti threaded rods

Designation	c_1	c_2	c_3	t_{min} [min]	t_{max} [min]
AM10 x L 4.8	260,907	29615,482	0,927769	30	146
AM12 x L 4.8	NPA ¹⁾	NPA	NPA	NPA	NPA
AM16 x L 4.8	NPA	NPA	NPA	NPA	NPA
AM 8.8 M10 x L	56,4981	62518,204	0,930393	45	130
AM 8.8 M12 x L	-315,1713	117316,0732	0,851412	42	130
AM 8.8 M16 x L	-315,1713	117316,0732	0,851412	42	130
AM10 A4-70 x L	-1321,3377	432114,1576	0,617514	43	120
AM12 A4-70 x L	-763,2431	538678,9931	0,887458	55	130
AM16 A4-70 x L	-315,1713	117316,0732	0,851412	42	130

¹⁾ NPA: No Performance Assessed

Table C2: Resistance $F_{Rk,t}$ to combined bending and tension load in case of fire after $t = 30, 60, 90$ and 120 minutes of Hilti threaded rods

Designation	$F_{Rk,30}$ [N]	$F_{Rk,60}$ [N]	$F_{Rk,90}$ [N]	$F_{Rk,120}$ [N]
AM10 x L 4.8 ¹⁾	1158	700	547	471
AM12 x L 4.8 ¹⁾	NPA ²⁾	NPA	NPA	NPA
AM16 x L 4.8 ¹⁾	NPA	NPA	NPA	NPA
AM 8.8 M10 x L ¹⁾	1991,4	1022,0	698,9	537,3
AM 8.8 M12 x L ¹⁾	3061,1	1396,4	841,5	564,0
AM 8.8 M16 x L ¹⁾	3061,1	1396,4	841,5	564,0
AM10 A4-70 x L ¹⁾	8078,6	3631,3	2148,9	1407,7
AM12 A4-70 x L ¹⁾	7290,2	7290,2	4634,4	3306,4
AM16 A4-70 x L ¹⁾	7290,2	7290,2	4634,4	3306,4

¹⁾ Cantilever arm length of threaded rod ≤ 150 mm

²⁾ NPA: No performance assessed

Hilti threaded rods AM10, AM12 and AM16 x L strength class 4.8, 8.8 and A4-70

Resistance to combined bending and tension in case of fire

Annex C1

Table D1: Calculation-based tension resistance $F_{Rk,t}$ in case of fire after $t = 30, 60, 90$ and 120 minutes of Hilti threaded rods

Designation	$F_{Rk,30}$ [N]	$F_{Rk,60}$ [N]	$F_{Rk,90}$ [N]	$F_{Rk,120}$ [N]
AM10 x L 4.8	1650	950	720	560
AM12 x L 4.8	2400	1380	1050	810
AM16 x L 4.8	4470	2560	1950	1520
AM 8.8 M10 x L	3310	1890	1440	1120
AM 8.8 M12 x L	4810	2750	2090	1630
AM 8.8 M16 x L	8950	5120	3900	3030
AM10 A4-70 x L	5040	1780	760	590
AM12 A4-70 x L	7330	2590	1100	860
AM16 A4-70 x L	13640	4820	2060	1600

Designation

$F_{Rk,t}$ Resistance after an exposure time t in case of fire [N]

Hilti threaded rods AM10, AM12 and AM16 x L strength class 4.8, 8.8 and A4-70

Calculation-based tension resistance in case of fire

Annex D1

Table D2: Calculation-based compression resistance $F_{Rk,t}$ in case of fire after $t = 30, 60, 90$ and 120 minutes of Hilti threaded rods AM10 x L 4.8

Installation length l [mm]	$F_{Rk,30}$ [N]	$F_{Rk,60}$ [N]	$F_{Rk,90}$ [N]	$F_{Rk,120}$ [N]
40	1240	740	560	440
50	1140	680	520	400
60	1030	630	480	370
70	920	570	430	340
80	820	520	390	310
90	720	460	350	280
100	640	420	320	250
110	570	370	280	220
120	500	330	250	200
130	450	300	230	180
140	400	270	200	160
150	360	240	180	140
160	320	220	170	130
170	290	200	150	120
180	260	180	140	110
190	240	170	130	100
200	220	150	120	90
210	200	140	110	80
220	190	130	100	80
230	170	120	90	70
240	160	110	80	70
250	150	100	80	60
260	140	100	70	60
270	130	90	70	50
280	120	80	60	50
290	110	80	60	50
300	110	70	60	40
310	100	70	50	40

Hilti threaded rods AM10, AM12 and AM16 x L strength class 4.8, 8.8 and A4-70

Calculation-based compression resistance in case of fire

Annex D2

Table D3: Calculation-based compression resistance $F_{Rk,t}$ in case of fire after $t = 30, 60, 90$ and 120 minutes of Hilti threaded rods AM12 x L 4.8

Installation length l [mm]	$F_{Rk,30}$ [N]	$F_{Rk,60}$ [N]	$F_{Rk,90}$ [N]	$F_{Rk,120}$ [N]
40	1910	1120	850	660
50	1780	1060	810	630
60	1650	990	760	590
70	1520	930	710	550
80	1390	860	650	510
90	1270	790	600	470
100	1150	730	550	430
110	1040	670	510	390
120	930	610	460	360
130	840	550	420	330
140	760	510	380	300
150	690	460	350	270
160	630	420	320	250
170	570	390	290	230
180	520	360	270	210
190	480	330	250	190
200	440	300	230	180
210	410	280	210	170
220	380	260	200	150
230	350	240	180	140
240	320	220	170	130
250	300	210	160	120
260	280	190	150	120
270	260	180	140	110
280	250	170	130	100
290	230	160	120	100
300	220	150	120	90
330	180	130	100	80
360	160	110	80	60
390	130	90	70	60
420	120	80	60	50
450	100	70	60	40

Hilti threaded rods AM10, AM12 and AM16 x L strenght class 4.8, 8.8 and A4-70

Calculation-based compression resistance in case of fire

Annex D3

Table D4: Calculation-based compression resistance $F_{Rk,t}$ in case of fire after $t = 30, 60, 90$ and 120 minutes of Hilti threaded rods AM16 x L 4.8

Installation length l [mm]	$F_{Rk,30}$ [N]	$F_{Rk,60}$ [N]	$F_{Rk,90}$ [N]	$F_{Rk,120}$ [N]
40	3800	2210	1680	1310
50	3630	2130	1620	1260
60	3460	2040	1560	1210
70	3290	1960	1490	1160
80	3120	1870	1420	1110
90	2940	1780	1350	1050
100	2760	1690	1280	1000
110	2580	1590	1210	940
120	2410	1500	1140	890
130	2240	1410	1080	840
140	2080	1330	1010	790
150	1930	1240	940	740
160	1790	1160	880	690
170	1660	1090	830	640
180	1540	1020	770	600
190	1430	950	720	560
200	1330	890	680	530
210	1240	830	630	490
220	1160	780	590	460
230	1080	730	560	430
240	1010	690	520	410
250	950	640	490	380
260	890	610	460	360
270	840	570	430	340
280	790	540	410	320
290	740	510	390	300
300	700	480	370	290
330	600	410	310	240
360	510	350	270	210
390	440	310	230	180
420	390	270	210	160
450	340	240	180	140

Hilti threaded rods AM10, AM12 and AM16 x L strenght class 4.8, 8.8 and A4-70

Calculation-based compression resistance in case of fire

Annex D4

Table D5: Calculation-based compression resistance $F_{Rk,t}$ in case of fire after $t = 30, 60, 90$ and 120 minutes of Hilti threaded rods AM 8.8 M10 x L

Installation length l [mm]	$F_{Rk,30}$ [N]	$F_{Rk,60}$ [N]	$F_{Rk,90}$ [N]	$F_{Rk,120}$ [N]
40	2356	1407	1048	815
50	2049	1252	921	717
60	1738	1089	791	615
70	1455	932	669	520
80	1216	791	563	438
90	1020	672	475	370
100	863	574	403	314
110	737	493	345	269
120	635	427	298	232
130	552	372	260	202
140	484	327	228	177
150	428	290	202	157
160	380	258	179	140
170	340	231	161	125
180	306	208	145	113
190	277	189	131	102
200	252	172	119	93
210	230	157	109	84
220	210	144	100	77
230	193	132	92	71
240	178	122	84	66
250	165	113	78	61
260	153	105	73	56
270	143	98	68	53
280	133	91	63	49
290	124	85	59	46
300	117	80	55	43
320	103	71	49	38
340	92	63	43	34
360	82	56	39	30
380	74	51	35	27
400	67	46	32	25
450	53	37	25	20
500	43	30	21	16
550	36	25	17	13
600	30	21	14	11

Hilti threaded rods AM10, AM12 and AM16 x L strength class 4.8, 8.8 and A4-70

Calculation-based compression resistance in case of fire

Annex D5

Table D6: Calculation-based compression resistance $F_{Rk,t}$ in case of fire after $t = 30, 60, 90$ and 120 minutes of Hilti threaded rods AM 8.8 M12 x L

Installation length l [mm]	$F_{Rk,30}$ [N]	$F_{Rk,60}$ [N]	$F_{Rk,90}$ [N]	$F_{Rk,120}$ [N]
40	3707	2185	1638	1275
50	3361	2013	1497	1165
60	2988	1825	1344	1045
70	2612	1628	1186	923
80	2258	1435	1035	805
90	1945	1256	897	698
100	1677	1096	778	605
110	1452	958	676	526
120	1264	840	591	460
130	1108	740	519	404
140	977	655	458	357
150	867	584	407	317
160	774	522	364	283
170	695	470	327	255
180	627	425	295	230
190	568	386	268	209
200	518	352	244	190
220	434	295	205	159
240	369	252	174	136
260	318	217	150	117
280	276	189	131	102
300	242	166	115	89
320	214	147	101	79
340	191	131	90	70
360	171	117	81	63
380	154	106	73	57
400	140	96	66	51
450	111	76	53	41
500	91	62	43	33
550	75	52	36	28
600	63	44	30	23
650	54	37	26	20
700	47	32	22	17
800	36	25	17	13

Hilti threaded rods AM10, AM12 and AM16 x L strenght class 4.8, 8.8 and A4-70

Calculation-based compression resistance in case of fire

Annex D6

Table D7: Calculation-based compression resistance $F_{Rk,t}$ in case of fire after $t = 30, 60, 90$ and 120 minutes of Hilti threaded rods AM 8.8 M16 x L

Installation length l [mm]	$F_{Rk,30}$ [N]	$F_{Rk,60}$ [N]	$F_{Rk,90}$ [N]	$F_{Rk,120}$ [N]
40	7515	4376	3302	2569
50	7104	4169	3133	2438
60	6656	3946	2950	2296
70	6172	3705	2752	2142
80	5662	3448	2543	1978
90	5146	3182	2327	1811
100	4642	2913	2114	1645
110	4169	2652	1910	1486
120	3736	2405	1721	1339
130	3349	2177	1550	1206
140	3007	1970	1396	1087
150	2707	1786	1261	981
160	2444	1621	1141	888
170	2215	1475	1036	806
180	2014	1346	943	734
190	1837	1232	862	671
200	1682	1131	790	615
220	1423	960	669	521
240	1218	824	574	446
260	1053	715	497	386
280	920	625	434	338
300	809	551	382	297
320	718	489	339	264
340	641	437	303	236
360	575	393	272	212
380	520	355	246	191
400	471	322	223	174
450	377	258	178	139
500	308	211	146	113
550	256	176	121	94
600	216	149	103	80
650	185	127	88	68
700	160	110	76	59
800	124	85	59	46
900	98	68	47	36
1000	80	55	38	30

Hilti threaded rods AM10, AM12 and AM16 x L strength class 4.8, 8.8 and A4-70

Calculation-based compression resistance in case of fire

Annex D7

Table D8: Calculation-based compression resistance $F_{Rk,t}$ in case of fire after $t = 30, 60, 90$ and 120 minutes of Hilti threaded rods AM10 x L A4-70

Installation length l [mm]	$F_{Rk,30}$ [N]	$F_{Rk,60}$ [N]	$F_{Rk,90}$ [N]	$F_{Rk,120}$ [N]
40	4301	1582	686	534
50	4110	1532	668	520
60	3910	1481	650	506
70	3700	1429	631	491
80	3482	1374	612	476
90	3257	1318	592	461
100	3029	1259	571	445
110	2804	1199	550	428
120	2585	1138	529	411
130	2377	1077	507	394
140	2182	1016	484	377
150	2003	956	462	359
160	1838	898	439	342
170	1689	842	417	325
180	1555	789	395	308
190	1433	739	374	291
200	1324	692	354	276
210	1225	648	335	261
220	1136	608	317	246
230	1056	570	299	233
240	984	535	283	220
250	918	503	268	208
260	859	474	253	197
270	804	446	240	186
280	755	421	227	177
290	710	398	215	168
300	669	376	204	159
320	596	338	185	144
340	534	305	167	130
360	482	276	152	118
380	436	251	139	108
400	397	229	127	99
450	319	185	104	81
500	262	153	86	67
550	219	128	72	56
600	185	109	62	48

Hilti threaded rods AM10, AM12 and AM16 x L strength class 4.8, 8.8 and A4-70

Calculation-based compression resistance in case of fire

Annex D8

Table D9: Calculation-based compression resistance $F_{Rk,t}$ in case of fire after $t = 30, 60, 90$ and 120 minutes of Hilti threaded rods AM12 x L A4-70

Installation length l [mm]	$F_{Rk,30}$ [N]	$F_{Rk,60}$ [N]	$F_{Rk,90}$ [N]	$F_{Rk,120}$ [N]
40	6435	2348	1015	790
50	6211	2289	994	773
60	5980	2229	972	756
70	5740	2168	950	739
80	5490	2105	927	722
90	5232	2040	904	704
100	4965	1973	881	685
110	4692	1905	857	667
120	4418	1834	832	647
130	4146	1762	807	628
140	3879	1689	781	608
150	3621	1615	754	587
160	3376	1541	728	566
170	3144	1468	701	545
180	2928	1395	673	524
190	2727	1325	646	503
200	2542	1257	619	482
220	2214	1128	567	441
240	1938	1012	518	403
260	1706	908	472	367
280	1511	817	429	334
300	1345	737	391	305
320	1204	667	357	278
340	1084	605	327	254
360	980	551	299	233
380	890	503	275	214
400	812	462	253	197
450	655	376	208	162
500	540	312	174	135
550	452	263	147	114
600	384	224	126	98
650	330	194	109	85
700	287	169	95	74
800	222	131	74	58

Hilti threaded rods AM10, AM12 and AM16 x L strenght class 4.8, 8.8 and A4-70

Calculation-based compression resistance in case of fire

Annex D9

Table D10: Calculation-based compression resistance $F_{Rk,t}$ in case of fire after $t = 30, 60, 90$ and 120 minutes of Hilti threaded rods AM16 x L A4-70

Installation length l [mm]	$F_{Rk,30}$ [N]	$F_{Rk,60}$ [N]	$F_{Rk,90}$ [N]	$F_{Rk,120}$ [N]
40	12423	4491	1934	1505
50	12123	4410	1904	1482
60	11821	4330	1875	1459
70	11512	4249	1845	1436
80	11197	4167	1815	1413
90	10873	4084	1785	1389
100	10540	3999	1755	1366
110	10197	3913	1724	1342
120	9844	3825	1693	1317
130	9483	3735	1661	1293
140	9116	3643	1629	1268
150	8744	3549	1596	1242
160	8369	3453	1562	1216
170	7995	3355	1528	1189
180	7625	3256	1493	1162
190	7262	3156	1458	1134
200	6907	3056	1422	1106
220	6234	2854	1349	1050
240	5616	2654	1275	992
260	5061	2461	1201	935
280	4566	2276	1128	878
300	4128	2103	1057	823
320	3742	1942	989	769
340	3403	1793	924	719
360	3104	1658	863	671
380	2839	1534	806	627
400	2606	1421	752	586
450	2129	1184	637	495
500	1769	997	542	422
550	1491	849	466	362
600	1274	730	403	314
650	1100	634	352	274
700	959	556	309	241
800	747	436	244	190
900	598	351	197	154
1000	490	288	163	127

Hilti threaded rods AM10, AM12 and AM16 x L strenght class 4.8, 8.8 and A4-70

Calculation-based compression resistance in case of fire

Annex D10

Figure E1: Example use case Hilti threaded rods on suspended rails

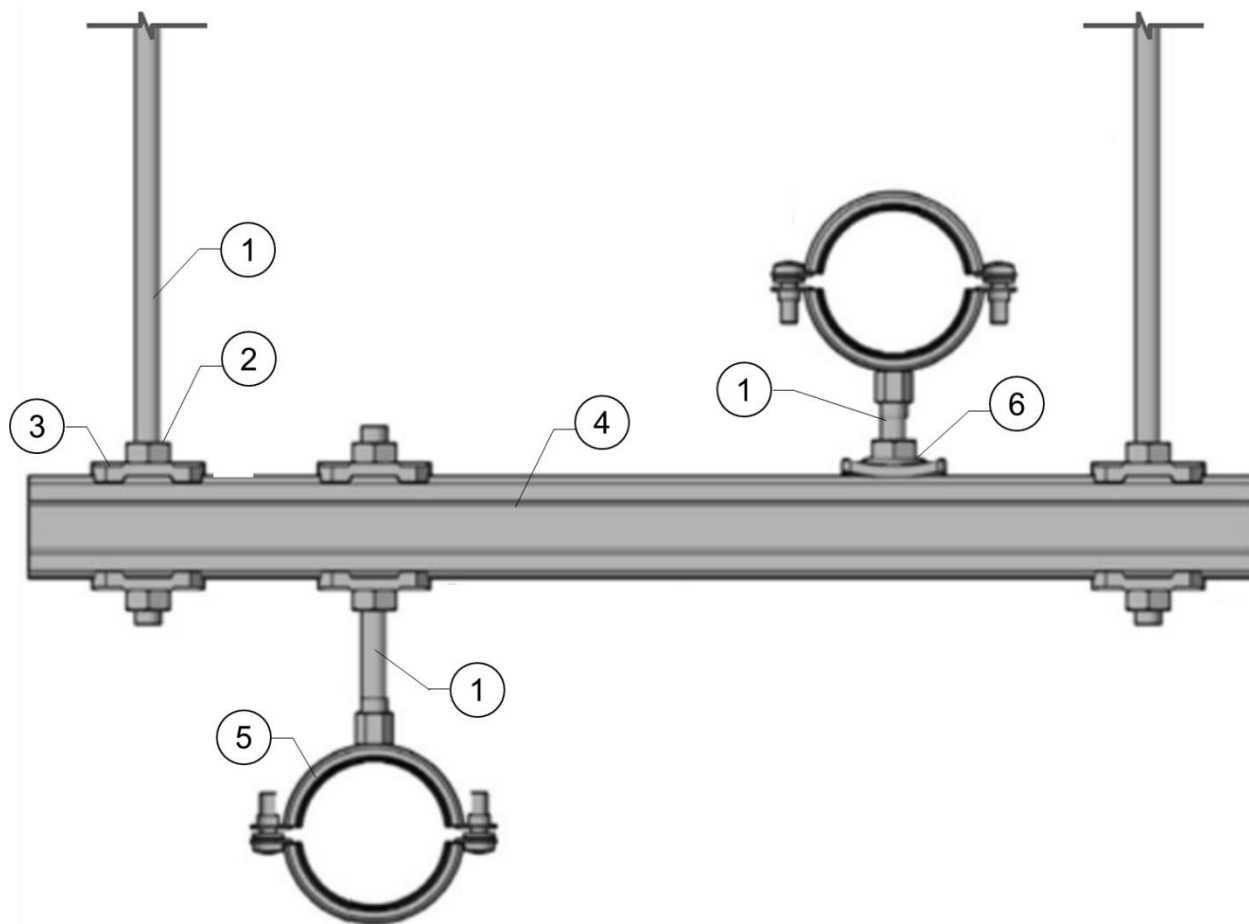

Legend

- | | | |
|---|----------------------|------------------------------------|
| 1 | Hilti threaded rod | |
| 2 | Hexagonal nut | (not an integral part of this ETA) |
| 3 | MQZ-L drilled plates | (not an integral part of this ETA) |
| 4 | Installation channel | (not an integral part of this ETA) |
| 5 | Pipe ring | (not an integral part of this ETA) |
| 6 | Pipe ring saddle | (not an integral part of this ETA) |

Hilti threaded rods AM10, AM12 and AM16 x L strength class 4.8, 8.8 and A4-70

Example usage: Hilti threaded rods on suspended rails

Annex E1
(informative)



European Technical Assessment

ETA-22/0810 of 20/12/2022

English translation prepared by CSTB - Original version in French language

General Part

Trade name:	Hilti drilled plate MQZ-L11 and Hilti drilled plate MQZ-L13
Product family:	Products for installation systems for supporting technical building equipment
Manufacturer:	Hilti AG Liechtenstein Feldkircherstraße 100 9494 Schaan FÜRSTENTUM LIECHTENSTEIN
Manufacturing plants:	L 9295
This European Technical Assessment contains:	12 pages including 10 pages of annexes which form an integral part of this assessment
This European Technical Assessment is issued in accordance with Regulation (EU) No 305/2011, on the basis of:	European Assessment Document (EAD) 280016-00-0602 version August 2017
This version replaces:	ETA-18/0102 of 21 September 2018

The European Technical Assessment is issued by the Technical Assessment Body in its official language. Translations of this European Technical Assessment in other languages shall fully correspond to the original issued document and shall be identified as such. Communication of this European Technical Assessment, including transmission by electronic means, shall be in full. However, partial reproduction may only be made with the written consent of the issuing Technical Assessment Body. Any partial reproduction shall be identified as such. This European Technical Assessment may be withdrawn by the issuing Technical Assessment Body, in particular pursuant to information by the Commission in accordance with Article 25(3) of Regulation (EU) No 305/2011.

1) Specific Part

1 Technical description of the product

The MQZ-L11 and MQZ-L13 drilled plates are steel plates that are stamped rectangularly with a centrally positioned opening, which is 11.5 mm or 13.5 mm in diameter. The plates have raised edges in the corners at the rear to ensure a perfect fit with the Hilti installation channels. Annex A describes the dimensions and materials of the MQZ-L11 and MQZ-L13 drilled plates.

Annex A describes the dimensions and materials of the Hilti MQZ-L11 and MQZ-L13 drilled plates.

Information on the intended use and the requirements for the performance assessment are given in Annex B.

2 Specification of the intended use

The performance given in Section 3 can only be assumed if the Hilti MQZ-L11 and MQZ-L13 drilled plates is used in compliance with the specifications and under boundary conditions set out in Annexes A to C. The test and assessment methods on which this European Technical Assessment is based lead to an assumption of a working life of the Hilti MQZ-L11 and MQZ-L13 drilled plates of at least 50 years in final use under ambient temperatures in indoor areas. The indications given on the working life cannot be interpreted as a guarantee given by the producer, but are to be regarded only as a means for choosing the right products in relation to the expected economically reasonable working life of the works.

In accordance with the European Assessment Document EAD 280016-00-0602, the product is intended to be used in

- a) installations for the support of sprinkler kits,
- b) installations for the support of other building service elements such as pipes, conduits, ducts and cables.

3 Performance of the product and references to the methods used for its assessment

3.1 Safety in case of fire (BWR 2)

Essential characteristic	Performance
Reaction to fire	Class A1
Pull-through resistance under fire exposure	See Annex C1

3.2 Safety and accessibility in use (BWR 4)

Essential characteristic	Performance
Shape	See Annex A1
Dimensions	See Annex A1
Material	See Annex A1
Characteristic pull through resistance	No performance determined

4 Assessment and verification of constancy of performance (AVCP) system applied, with reference to its legal base

In accordance with the European Assessment Document EAD 280016-00-0602, the following legal bases apply:

- In case of intended use a) specified in Section 2:
Decision of the commission N° 1996/577/EC as amended by Commission Decision 2002/592/EC.:
System 1 applies for the assessment and verification of constancy of performance (AVCP).
- In case of intended use b) specified in Section 2:
Decision of the commission N° 1999/472/EC as amended by Commission Decision 2001/596/EC.:
System 3 applies for the assessment and verification of constancy of performance (AVCP).

5 Technical details necessary for the implementation of the AVCP system, as provided for in the applicable EAD

The technical details necessary for the implementation of the system for the assessment and verification of constancy of performance are laid down in the control plan (confidential part of this European Technical Assessment) deposited at Centre Scientifique et Technique du Bâtiment.

The manufacturer shall, on the basis of a contract, involve a notified body approved in the field of supporting systems for issuing the certificate of conformity CE based on the control plan.

The original French version is signed by

La cheffe de division, Anca CRONOPOL

Figure A1: Geometry and dimensions of MQZ-L11 and MQZ-L13 drilled plates

Item number	Designation	D [mm]	Materials	Illustration
2199455	MQZ-L11	11,5	S235JR in accordance with DIN EN 10025-2	
2199456	MQZ-L13	13,5		

Hilti drilled plates MQZ-L11 and MQZ-L13

Product Description
 Dimensions and materials

Annex A1

- MQZ-L11 and MQZ-L13 drilled plates are used in building services engineering installation systems at ambient temperature and at elevated temperatures. MQZ-L11 and MQZ-L13 drilled plates are used to transfer building services component loads such as ducts and equipment for sprinklers, wastewater, drinking water, heating, cooling, ventilation, electrical and other installations. MQZ-L11 and MQZ-L13 described in this ETA are suitable for undertaking this load-bearing function under the conditions listed in section 2.
- The resistance and deformation in case of fire are referring to the boundary conditions of the standard temperature time curve (STTC) in accordance with EN 1363-1.
- MQZ-L11 and MQZ-L13 drilled plates are used to fix threaded rods to installation channels or brackets in conjunction with hexagonal nuts.
- The installation instructions described in Annex E are a prerequisite for the information on the performance assessment in Annex C and D
- MQZ-L11 drilled plates are used in pairs in conjunction with Hilti threaded rods in strength class ≥ 4.8 in accordance with DIN 976-1 as per Table B1; hexagonal nuts in strength class ≥ 8 in accordance with DIN 934 as per Table B2; and Hilti installation channels according to Annex B3, B4, B5 and B6.

Table B1: Threaded rods for use with Hilti drilled plates MQZ-L11

Illustration	Item number	Designation	M Thread	L [mm]	Material
	339795	AM10x1000 4.8	M10	1000	Strength class 4.8 in accordance with DIN 976-1, zinc coated
	339796	AM10x2000 4.8	M10	2000	
	216418	AM10x3000 4.8	M10	3000	

Table B2: Hexagonal nuts for use with Hilti drilled plates MQZ-L11

Illustration	Item number	Designation	M thread	W [mm]	H [mm]	Material
	216466	M10 hexagonal nut	M10	17	8	Strength class 8 in accordance with DIN 934, zinc coated

- MQZ-L13 drilled plates are used in pairs in conjunction with Hilti threaded rods in strength class ≥ 4.8 in accordance with DIN 976-1 as per Table B23; hexagonal nuts in strength class ≥ 8 in accordance with DIN 934 as per Table B4; and Hilti installation channels according to Annex B3, B4, B5 and B6.

Hilti drilled plates MQZ-L11 and MQZ-L13

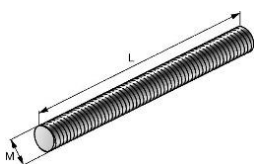
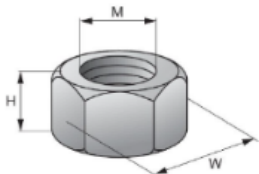
Requirements for performance assessment

Annex B1

Table B3: Threaded rods for use with Hilti drilled plates MQZ-L13

Illustration	Item number	Designation	M thread	L [mm]	Material
	339797	AM12x1000 4.8	M12	1000	Strength class 4.8 in accordance with DIN 976-1, zinc coated
	216420	AM12x2000 4.8	M12	2000	
	216421	AM12x3000 4.8	M12	3000	

Table B4: Hexagonal nuts for use with Hilti drilled plates MQZ-L13

Illustration	Item number	Designation	M thread	W [mm]	H [mm]	Material
	2184554	M12 hexagonal nut	M12	19	10	Strength class 8 in accordance with DIN 934, zinc coated

Hilti drilled plates MQZ-L11 and MQZ-L13

Requirements for performance assessment

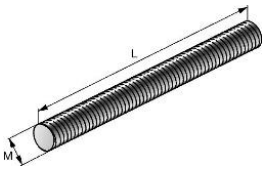
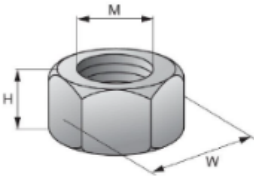
Annex B2

Table B5: Dimensions and materials of Hilti MQ-41/3 3M, MQ-41/3 6M, MQ-41/3 3M LL, MQ-41/3 6M LL, MQ-41 D 3M and MQ-41 D 6M installation channels for use with Hilti drilled plates MQZ-L

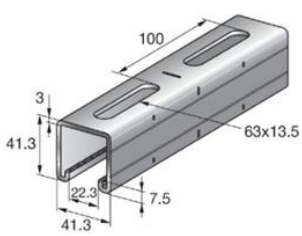
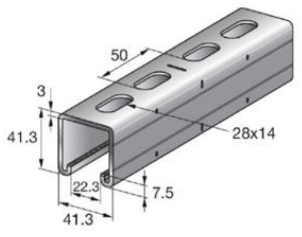
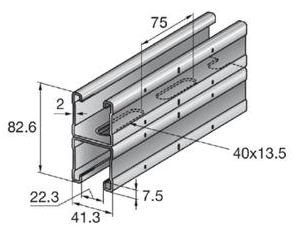
Figure ¹⁾	Item number	Designation	Materials and coatings
	369596	MQ-41/3 3M	S250GD+Z275-M-A-C according to EN 10346
	369597	MQ-41/3 6M	
	2048102	MQ-41/3 3M LL	S250GD+Z275-M-A-C according to EN 10346
	2048103	MQ-41/3 6M LL	
 <p>Two profiles of MQ-41 D channel are connected in the area of the holes in the back of the channels in a shape-fitting and force-fitting way as a kind of riveted connection.</p>	369603	MQ-41 D 3m	S250GD+Z275-M-A-C according to EN 10346
	369604	MQ-41 D 6m	

¹⁾ Dimensions in mm

Hilti drilled plates MQZ-L11 and MQZ-L13

Requirements for performance assessment

Annex B3

Table B6: Dimensions and materials of Hilti MQ-21.5 6m, MQ-21.5 3m, MQ-21.5 2m, MQ-41 6m, MQ-41 3m, MQ-41 2m, MQ-41-L 6m, MQ-41-L 3m and MQ-41-L2m installation channels for use with Hilti drilled plates MQZ-L

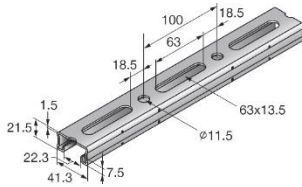
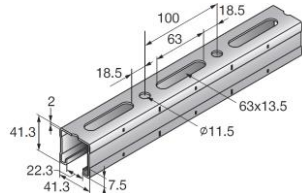
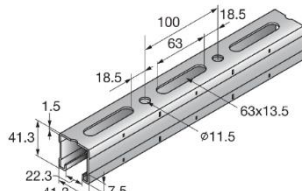
Figure ¹⁾	Item number	Designation	Materials and coatings
	2184773	MQ-21.5 6m	S280GD+Z140-M-A-C according to DIN EN 10346
	2184772	MQ-21.5 3m	
	2184771	MQ-21.5 2m	
	369592	MQ-41 6m	S250GD+Z275-M-A-C according to DIN EN 10346
	369591	MQ-41 3m	
	304559	MQ-41 2m	
	2141964	MQ-41-L 6m	S250GD+Z140-M-A-C according to DIN EN 10346
	2141965	MQ-41-L 3m	
	2141966	MQ-41-L 2m	

¹⁾ Dimensions in mm

Hilti drilled plates MQZ-L11 and MQZ-L13

Requirements for performance assessment

Annex B4

Table B7: Dimensions and materials of Hilti MT-30 S, MT-30, MT-30 S OC, MT-30 OC, MT-40 S, MT-40, MT-40 S OC and MT-40 OC installation channels for use with Hilti drilled plates MQZ-L

Figure ¹⁾	Item number	Designation	Length [m]	Materials and coatings
	2268497	MT-30 S	3	S250GD+ Z275-M-A-C acc. to EN 10346
	2268498	MT-30	6	
	2268499	MT-30 S OC	3	S280GD+ ZM310-A-C acc. to EN 10346
	2268500	MT-30 OC	6	
	2268505	MT-40 S	3	S280GD+ Z275-M-A-C acc. to EN 10346
	2268506	MT-40	6	
	2268507	MT-40 S OC	3	S280GD+ ZM310-A-C acc. to EN 10346
	2268508	MT-40 OC	6	

¹⁾ Dimensions en mm

Hilti drilled plates MQZ-L11 and MQZ-L13

Requirements for performance assessment

Annex B5

Table B8: Hilti MT-50 S, MT-50, MT-50 S OC, MT-50 OC, MT-40D S, MT-40D, MT-40D S OC, MT-40D OC installation channels for use with Hilti drilled plates MQZ-L

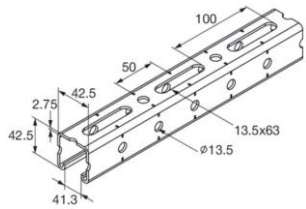
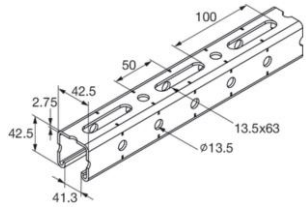
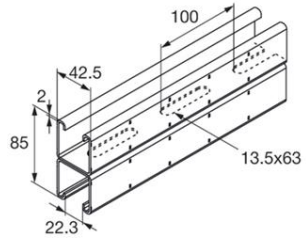
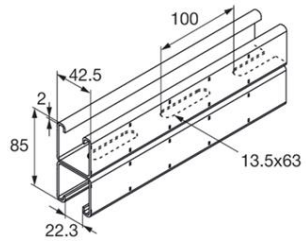
Figure ¹⁾	Item number	Designation	Length [m]	Materials and coatings
	2268509	MT-50 S	3	S280GD+ Z275-M-A-C acc. to EN 10346
	2268510	MT-50	6	
	2268511	MT-50 S OC	3	S280GD+ ZM310-A-C acc to. EN 10346
	2268512	MT-50 OC	6	
	2268517	MT-40D S	3	S280GD+ Z275-M-A-C acc. to EN 10346
	2268518	MT-40D	6	
	2268519	MT-40D S OC	3	S280GD+ ZM310-A-C acc to. EN 10346
	2268520	MT-40D OC	6	

¹⁾ Dimensions en mm

Hilti drilled plates MQZ-L11 and MQZ-L13

Characteristic tensile strength at ambient temperature

Annex B6

Table D1: Resistance of $F_{Rk,t}$ of MQZ-L drilled plates in case of fire after $t = 30, 60, 90$ and 120 minutes in combination with threaded rods $\geq M10$ strength class ≥ 4.8

Drilled plates	Installation channel	Parameter of regression curve	$F_{Rk,t}$ [N]			
		$F_{Rk}(t) = c_3 (c_1 + c_2 / t)$	$F_{Rk,30}$	$F_{Rk,60}$	$F_{Rk,90}$	$F_{Rk,120}$
MQZ-L11 MQZ-L13	MQ-41/3	$c_1 = 963,5$ $c_2 = 76594,354$ $c_3 = 0,847958$ $25 \text{ min} \leq t \leq 150 \text{ min}$	1491	949	769	679
	MQ-41/3 LL					
	MT-30	$c_1 = 427,2416$ $c_2 = 130158,0662$ $c_3 = 0,910073$ $33 \text{ min} \leq t \leq 130 \text{ min}$	2168,65	1181,5	852,5	687,95
	MT-30 S					
	MT-30 OC					
	MT-30 S OC					
	MT-40					
	MT-40 S					
	MT-40 OC					
	MT-40 S OC					
	MT-50					
	MT-50 S					
	MT-50 OC					
	MT-50 S OC					
	MT-40D					
	MT-40D S					
	MT-40D OC					
	MT-40D S OC					

Designation

$F_{Rk,t}$ Resistance after an exposure time t in case of fire [N]
 $F_{Rk}(t)$ Resistance time function in case of fire [N]

Hilti drilled plates MQZ-L11 and MQZ-L13

Characteristic resistance in case of fire

Annex C1

Figure E1: Bill of material and instructions for use

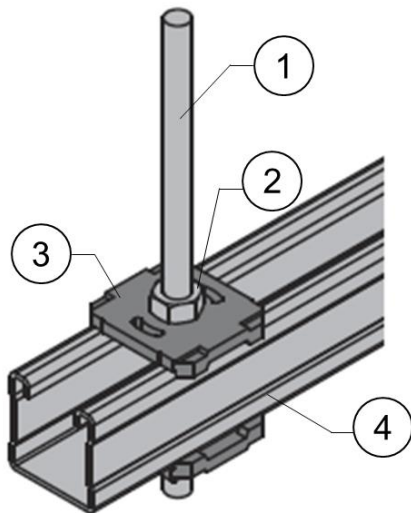

Bill of material					
Part of typical	Ref.	Opt.	Item No.	Description	
Setup	Fixation	1	339795	AM10x1000 4.8 threaded rod	
			339796	AM10x2000 4.8 threaded rod	
			216418	AM10x3000 4.8 threaded rod	
		2	B	339797	AM12x1000 4.8 threaded rod
				216420	AM12x2000 4.8 threaded rod
				216421	AM12x3000 4.8 threaded rod
MQZ-L		3	A	2199455	MQZ-L11 drilled plate
			B	2199456	MQZ-L13 drilled plate
Channel	Support	A	369596	MQ-41/3 3M installation channel	
			369597	MQ-41/3 6M installation channel	
			2048102	MQ-41/3 3M LL installation channel	
			2048103	MQ-41/3 6M LL installation channel	
		B	369603	MQ-41 D 3M installation channel	
			369604	MQ-41 D 6M installation channel	
		C	369592	MQ-41 6m installation channel	
			369591	MQ-41 3m installation channel	
			304559	MQ-41 2m installation channel	
			2141964	MQ-41 L 6m installation channel	
		D	2141965	MQ-41 L 3m installation channel	
			2141966	MQ-41 L 2m installation channel	
			2268497	MT-30 S installation channel	
			2268498	MT-30 installation channel	
E	2268499	MT-30 S OC installation channel			
	2268500	MT-30 OC installation channel			
	2268505	MT-40 S installation channel			
	2268506	MT-40 installation channel			
F	2268507	MT-40 S OC installation channel			
	2268508	MT-40 OC installation channel			
	2268509	MT-50 S installation channel			
	2268510	MT-50 installation channel			
G	2268511	MT-50 S OC installation channel			
	2268512	MT-50 OC installation channel			
	2268517	MT-40D S installation channel			
	2268518	MT-40D installation channel			
2268519	MT-40D S OC installation channel				
2268520	MT-40D OC installation channel				

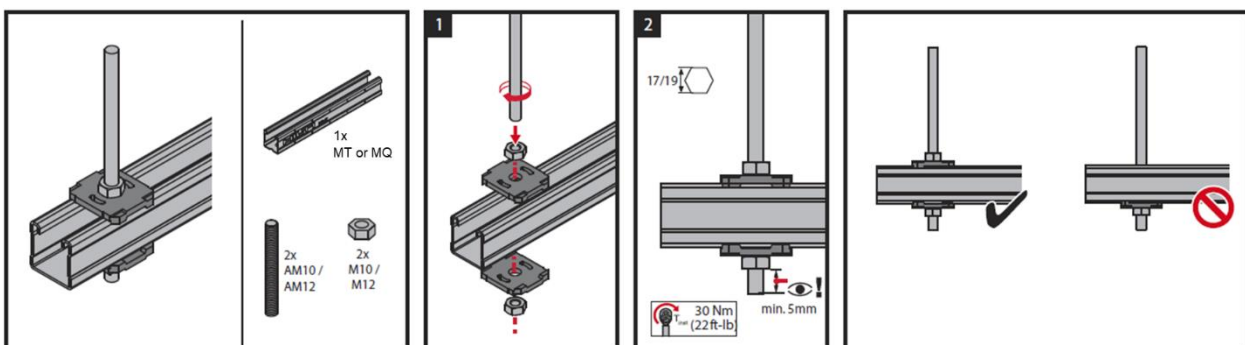

Hilti drilled plates MQZ-L11 and MQZ-L13

General assembly instructions

Annex D1
(informative)



European Technical Assessment

ETA-23/0105 of 18/08/2023

English translation prepared by CSTB - Original version in French language

General Part

Technical Assessment Body issuing the European Technical Assessment:

Centre Scientifique et Technique du Bâtiment (CSTB)

Trade name of the construction product:

Hilti installation channels of MT System

Product family to which the construction product belongs:

Products for installation systems for supporting technical building equipment

Manufacturer:

Hilti AG Liechtenstein
Feldkircherstraße 100
9494 Schaan
FÜRSTENTUM LIECHTENSTEIN

Manufacturing plants:

L 8321, L 1138282

This European Technical Assessment contains:

57 pages including 54 pages of annexes which form an integral part of this assessment

This European Technical Assessment is issued in accordance with Regulation (EU) No 305/2011, on the basis of:

European Assessment Document (EAD)
280016-00-0602 version June 2020

This version replaces:

-

The European Technical Assessment is issued by the Technical Assessment Body in its official language. Translations of this European Technical Assessment in other languages shall fully correspond to the original issued document and shall be identified as such. Communication of this European Technical Assessment, including transmission by electronic means, shall be in full. However, partial reproduction may only be made with the written consent of the issuing Technical Assessment Body. Any partial reproduction shall be identified as such. This European Technical Assessment may be withdrawn by the issuing Technical Assessment Body, in particular pursuant to information by the Commission in accordance with Article 25(3) of Regulation (EU) No 305/2011.

Specific Part

1 Technical description of the product

This European Technical Assessment covers Hilti installation channels of MT System: MT-10, MT-15, MT-15 OC, MT-20, MT-20 OC, MT-30 S, MT-30, MT-30 S OC, MT-30 OC, MT-40 S, MT-40, MT-40 S OC, MT-40 T, MT-40 T OC, MT-40 OC, MT-40D S, MT-40D, MT-40D S OC, MT-40D OC, MT-50 S, MT-50, MT-50 S OC, MT-50 OC, MT-70 S OC, MT-70 OC, MT-80 S OC, MT-80 OC, MT-90 S OC, MT-90 OC, MT-100 S OC and MT-100 OC.

The Hilti installation channels MT-10, MT-15, MT-15 OC, MT-20, MT-20 OC, MT-40 T and MT-40 T OC are made of thin-walled steel in L- or C-shape. Recesses in the form of oblong and round holes allow the use of fasteners and fixtures.

The Hilti installation channels MT-30 S, MT-30, MT-30 S OC, MT-30 OC, MT-40 S, MT-40, MT-40 S OC, MT-40 OC, MT-50 S, MT-50, MT-50 S OC, MT-50 OC, MT-60, MT-60 S, MT-60 OC and MT-60 S OC are made of thin-walled steel with parallel flanges. The flanges are turned at the end which makes it possible to force-fit the channels to specific channel system fixtures. Recesses in the back and/or in the flanges of the channels in the form of oblong holes and round holes allow the use of fasteners and fixtures.

The HILTI installation channels MT-70 S OC, MT-70 OC, MT-80 S OC, MT-80 OC, MT-90 S OC, MT-90 OC, MT-100 S OC and MT-100 OC are made of thin-walled steel closed profiles in square or rectangular shape with recesses in the form of dome shape round holes on the inner sides to allow use of fasteners and fixtures.

The HILTI installation channels MT-40D S, MT-40D, MT-40D S OC and MT-40D OC consists of two profiles of similar types as MT-40 S, MT-40, MT-40 S OC and MT-40 OC which are connected in the area of the holes in the back of the channels in a shape-fitting and force-fitting way.

The MT installation open profile channels and closed profiles (girders) can be cut along the entire length following the manufacturers instructions without compromising the declared performances.

The drawings, dimensions and materials of the Hilti installation channels of MT System are given in Annex A.

2 Specification of the intended use

The performances given in clause 3 are only valid if HILTI installation channels of MT System are in compliance with the specifications and conditions given in Annex B.

The provisions made in this European Technical Assessment are based on an assumed working life of the HILTI installation channels of MT System of 50 years when installed in the works (provided that the installation systems products are subject to appropriate installation). The indications given on the working life cannot be interpreted as a guarantee given by the producer or Technical Assessment Body, but are to be regarded only as a means for choosing the right products in relation to the expected economically reasonable working life of the works.

In accordance with the European Assessment Document EAD 280016-00-0602, the product is intended to be used in:

- a) installations for the support of sprinkler kits,
- b) installations for the support of technical building equipment in general.

3 Performance of the product and references to the methods used for its assessment

3.1 Safety in case of fire (BWR 2)

No.	Essential characteristic	Performance
1	Reaction to fire	Class A1
2	Pull-through resistance of channel back holes under fire exposure	See Annex C
3	Bending characteristics under fire exposure	See Annex D

3.2 Safety and accessibility in use (BWR 4)

No.	Essential characteristic	Performance
4	Shape	See Annex A
5	Dimensions	See Annex A
6	Material and cross-section characteristics	See Annex A and B
7	Characteristic pull-through resistance of channel back holes at ambient temperatures	No Performance Assessed

4 Assessment and verification of constancy of performance (AVCP) system applied, with reference to its legal base

In accordance with the European Assessment Document EAD 280016-00-0602, the following legal bases apply:

- In case of intended use a) specified in Section 2:
Decision of the commission N° 1996/577/EC as amended by Commission Decision 2002/592/EC:
System 1 applies for the assessment and verification of constancy of performance (AVCP).
- In case of intended use b) specified in Section 2:
Decision of the commission N° 97/161/EC:
System 2+ applies for the assessment and verification of constancy of performance (AVCP).

5 Technical details necessary for the implementation of the AVCP system, as provided for in the applicable EAD

The technical details necessary for the implementation of the system for the assessment and verification of constancy of performance are laid down in the control plan (confidential part of this European Technical Assessment) deposited at Centre Scientifique et Technique du Bâtiment.

The manufacturer shall, on the basis of a contract, involve a notified body approved in the field of supporting systems for issuing the certificate of conformity CE based on the control plan.

The original French version is signed by

La cheffe de division, Anca CRONOPOL

Table A1: Dimensions and materials of Hilti MT-10, MT-15, MT-15 OC, MT-20, MT-20 OC, MT-30 S, MT-30, MT-30 S OC and MT-30 OC installation channels

Illustration (Dimensions in mm and inch)	Item number	Designation	Length [m]	Materials and coatings
	2268492	MT-10	2	S280GD or equivalent as defined in HN704 + Z275-M-A-C acc. to EN 10346
	2268493	MT-15	2	S280GD or equivalent as defined in HN704 + Z275-M-A-C acc. to EN 10346
	2268494	MT-15 OC	2	S280GD or equivalent as defined in HN704 + ZM310-A-C acc. to EN 10346
	2268495	MT-20	2	S280GD or equivalent as defined in HN704 + Z275-M-A-C acc. to EN 10346
	2268496	MT-20 OC	2	S280GD or equivalent as defined in HN704 + ZM310-A-C acc. to EN 10346
	2268497	MT-30 S	3	S280GD or equivalent as defined in HN704 + Z275-M-A-C acc. to EN 10346
	2268498	MT-30	6	
	2268499	MT-30 S OC	3	S280GD or equivalent as defined in HN704 + ZM310-A-C acc. to EN 10346
	2268500	MT-30 OC	6	

Hilti MT channels

Product description

Annexe A1

Table A2: Dimensions and materials of Hilti MT-40 S, MT-40, MT-40 S OC, MT-40 OC, MT-40 T, MT-40 T OC, MT-50 S, MT-50, MT-50 S OC, MT-50 OC, MT-60 S, MT-60, MT-60 S OC, and MT-60 OC, installation channels

Illustration (Dimensions in mm and inch)	Item number	Designation	Length [m]	Materials and coatings
	2268505	MT-40 S	3	S280GD or equivalent as defined in HN704 + Z275-M-A-C acc. to EN 10346
	2268506	MT-40	6	
	2268507	MT-40 S OC	3	S280GD or equivalent as defined in HN704 + ZM310-A-C acc. to EN 10346
	2268508	MT-40 OC	6	
	2268502	MT-40 T	6	S280GD or equivalent as defined in HN704 + Z275-M-A-C acc. to EN 10346
	2268504	MT-40 T OC	6	S280GD or equivalent as defined in HN704 + ZM310-A-C acc. to EN 10346
	2268509	MT-50 S	3	S280GD or equivalent as defined in HN704 + Z275-M-A-C acc. to EN 10346
	2268510	MT-50	6	
	2268511	MT-50 S OC	3	S280GD or equivalent as defined in HN704 + ZM310-A-C acc. to EN 10346
	2268512	MT-50 OC	6	
	2268513	MT-60 S	3	S280GD or equivalent as defined in HN704 + Z275-M-A-C acc. to EN 10346
	2268514	MT-60	6	
	2268515	MT-60 S OC	3	S280GD or equivalent as defined in HN704 + ZM310-A-C acc. to EN 10346
	2268516	MT-60 OC	6	

Hilti MT channels

Product description

Annexe A2

Table A3: Dimensions and materials of Hilti, MT-40D S, MT-40D, MT-40D S OC and MT-40 D OC installation channels

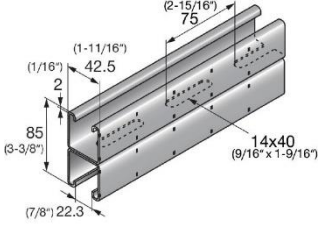
Illustration (Dimensions in mm and inch)	Item number	Designation	Length [m]	Materials and coatings
 <p>Two profiles of MT-40 channel are connected in the area of the holes in the back of the channels in a shape-fitting and force-fitting way as a kind of riveted connection.</p>	2268517	MT-40D S	3	S280GD or equivalent as defined in HN704 + Z275-M-A-C acc. to EN 10346
	2268518	MT-40D	6	
	2268519	MT-40D S OC	3	S280GD or equivalent as defined in HN704 + ZM310-A-C acc. to EN 10346
	2268520	MT-40D OC	6	

Hilti MT channels

Product description

Annexe A3

Table A4: Dimensions and materials of Hilti MT-70 S OC, MT-70 OC, MT-80 S OC, MT-80 OC, MT-90 S OC, MT-90 OC, MT-100 S OC and MT-100 OC installation channels

Illustration (Dimensions in mm and inch)	Item number	Designation	Length [m]	Materials and coatings
	2268364	MT-70 S OC	3	S350GD+ ZM310-A-C acc. to EN 10346
	2268365	MT-70 OC	6	
	2268366	MT-80 S OC	3	S350GD+ ZM310-A-C acc. to EN 10346
	2268367	MT-80 OC	6	
	2268368	MT-90 S OC	3	S350GD+ ZM310-A-C acc. to EN 10346
	2268369	MT-90 OC	6	
	2268490	MT-100 S OC	3	S350GD+ ZM310-A-C acc. to EN 10346
	2268491	MT-100 OC	6	

Hilti MT channels

Product description

Annexe A4

Table B1: Dimensions and materials of Hilti MQZ-L11 and MQZ-L13 drilled plates

Item number	Designation	D [mm]	Materials	Illustration (Dimensions in mm and inch)
2199455	MQZ-L11	11,5	S235JR in accordance with DIN EN 10025-2, zinc coated	
2199456	MQZ-L13	13,5		

Hilti MQZ-L drilled plates

Requirements for performance assessment

Annex B1

Table B2: Fasteners for channel fixation through round back holes

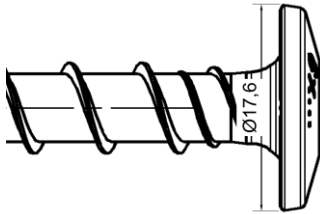
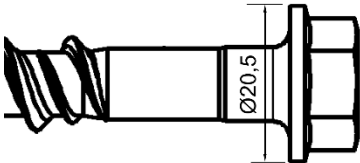
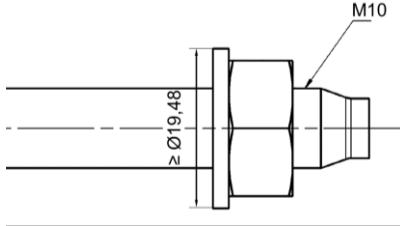
Designation	Description	Dimensions of anchor head (in mm)
HUS3-P6 x L ¹⁾	Screw anchor	
HUS4-H8 x L ¹⁾	Screw anchor	
HST3-M10 x L ¹⁾	Stud anchor with M10 thread	
Bolt M10 + 10.5 washer	M10 threaded bolt ≥ 4.8 and A4-70	Washer EN ISO 7089-10.5-200HV with M10 hexagonal nut strength class ≥ 8 ISO 4032

¹⁾ L = length of anchor, see manufacturers brochures

Hilti anchors for channel fastening

Requirements for performance assessment

Annex B2

Table B3: Fasteners for channel fixation through slotted back holes with MQZ-L 11 and MQZ-L 13 drilled plates

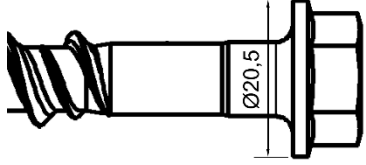
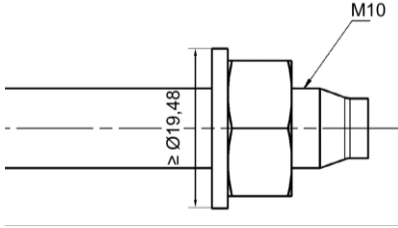
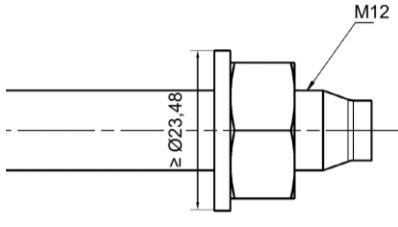
Designation	Description	Dimensions of anchor head (in mm)	Drilled plate
HUS4-H10 x L ²⁾	Screw anchor		MQZ-L13
HST3-M10 x L ²⁾	Stud anchor with M10 thread		MQZ-L11
HST3-M12 x L ²⁾	Stud anchor with M12 thread		MQZ-L13
Bolt M10	M10 threaded bolt ≥ 4.8 and A4-70	Washer EN ISO 7089-10.5-200HV with M10 hexagonal nut strength class ≥ 8 ISO 4032	MQZ-L11
Bolt M12	M12 threaded bolt ≥ 4.8 and A4-70	Washer EN ISO 7089-13-200HV with M12 hexagonal nut strength class ≥ 8 ISO 4032	MQZ-L13

²⁾ L = length of anchor, see manufacturers brochures

Hilti anchors for channel fastening

Requirements for performance assessment

Annex B3

Specifications of intended use

- Hilti channels of MT System are used to transfer building services components loads such as ducts and equipment for water, heating, cooling, ventilation, electrical and other systems. Hilti MT channels are performing this loadbearing function under conditions described in Section 2 of this European Technical Assessment.
- Hilti MT-30, MT-40, MT-40D, MT-50, MT-70 and MT-80 installation channels (regardless of length and coating) in the scope of this European Technical Assessment are used for applications at ambient temperature and in case of fire.
- Hilti MT-10, MT-15, MT-20, MT-90 and MT-100 installation channels (regardless of length and coating) in the scope of this European Technical Assessment are used only for applications at ambient temperature.
- The resistance and deformation at ambient temperatures apply for static and centric loads.
- The resistance and deformation in case of fire are referring to the boundary conditions of the standard temperature / time curve (STTC) in accordance with EN 1363-1.
- MT channels used in headrail systems are installed with the channel profile opening facing away from the ceiling. In case of fire approved fire tested components are attached underneath using Hilti MQA-M10-B, MQA-M12-B or MQA-M16-B pipe ring saddles. The channels are mounted to the base material for use in case of fire using MQZ-L11 or MQZ-L13 drilled plates in conjunction with suitable approved fasteners. MT channels can be mounted on the base material for use at ambient temperatures with suitable fasteners through the longhole without using MQZ-L11 or MQZ-L13 drilled plates. MT-30, MT-40 and MT-50 channels can be mounted to the base material for use at ambient and in case of fire with suitable fasteners through the roundhole without using MQZ-L11 or MQZ-L13 drilled plates.
- The pull-through resistance of the round-holes in the back of the channels in case of fire results in combination with the fasteners specified in Table B2.
- In the case of suspended channel systems (e.g. rod-trapeze), the open side of the channel profile can be orientated upwards or downwards.
- The MT installation open profile channels and closed profiles (girders) can be cut along the entire length following the manufacturers instructions without compromising the declared performances.
- For girders the distance between the end of the girder and start of the dome shaped hole has to be minimum 10 mm.

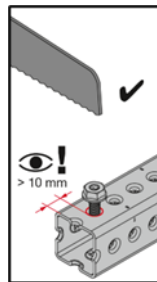

- For channels the distance between the end of the channel and center of the first hole from channel end has to be minimum 25 mm.

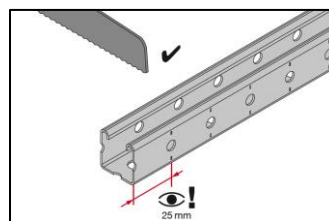

- Threaded rods and other fixtures are only to be guided through the roundholes or longholes of the channel.

Hilti MT channels

**Intended use
 Specifications**

Annex B4

- The fastening of the base connector to the base material is made with appropriate anchors. The anchoring used with the base material must be suitable and have a fireproof certificate.
- Prior to installation, it must be ensured that the supported component, the anchoring of the threaded rod to the base material and the base material itself are suitable to withstand the resistance values of the installation system and that they have a fireproof certificate.
- The installation channels must be installed by appropriately qualified personnel and under the supervision of the site manager. The general installation instructions of the manufacturer apply

Hilti MT channels

Intended use
Specifications

Annex B5

Table B4: Properties of the cross section of Hilti channels MT-10, MT-15, MT-15 OC, MT-20, and MT-20 OC

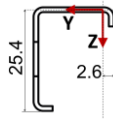
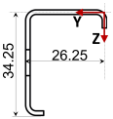
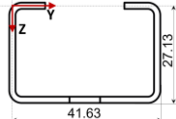
Description	Symbol	Unit	MT-10	MT-15 / MT-15 OC	MT-20 / MT-20 OC
Cross section (Dimensions in mm and inch)	-	-			
Classification cross section in accordance with EN 1993-1-1	-	-	3	3	3
Cross section areas	A	cm ²	0.49	0.85	1.49
	A _{tot}	cm ²	0.49	0.85	1.49
Shear areas	A _y	cm ²	NPA	NPA	NPA
	A _z	cm ²	NPA	NPA	NPA
Centroid position	y _{C,0}	cm	1.22	1.93	2.02
	z _{C,0}	cm	0.92	1.19	1.64
Moments of inertia	I _y	cm ⁴	0.41	1.27	1.86
	I _z	cm ⁴	0.23	0.72	3.66
Polar moments of inertia	I _p	cm ⁴	0.64	1.98	5.52
	I _{p,M}	cm ⁴	1.26	3.80	14.71
Radii of gyration	i _y	cm	0.91	1.22	1.12
	i _z	cm	0.69	0.92	1.57
Polar radii of gyration	i _p	cm	1.14	1.53	1.92
	i _{p,M}	cm	1.61	2.11	3.14
Warping radius of gyration	i _{w,M}	cm	NPA	NPA	NPA
Torsional constant	J	cm ⁴	NPA	NPA	NPA
Secondary torsional constant	J _s	cm ⁴	NPA	NPA	NPA
Location of the shear center	y _{M,0}	cm	NPA	NPA	NPA
	z _{M,0}	cm	NPA	NPA	NPA
	y _M	cm	NPA	NPA	NPA
	z _M	cm	NPA	NPA	NPA
Warping constant	I _{w,C}	cm ⁶	NPA	NPA	NPA
	I _{w,M}	cm ⁶	NPA	NPA	NPA
Section moduli	S _{y,max}	cm ³	0.25	0.57	1.78
	S _{y,min}	cm ³	-0.41	-1.00	-1.08
	S _{z,max}	cm ³	0.45	1.03	1.73
	S _{z,min}	cm ³	-0.16	-0.36	-1.73
Torsional section modulus	S _t	cm ³	NPA	NPA	NPA
Max. plastic bending moment	M _{pl,y,k}	kNm	NPA	NPA	NPA
	M _{pl,z,k}	kNm	NPA	NPA	NPA
Max. plastic section moduli	Z _y	cm ³	NPA	NPA	NPA
	Z _z	cm ³	NPA	NPA	NPA
Plastic shear areas	A _{pl,y}	cm ²	NPA	NPA	NPA
	A _{pl,z}	cm ²	NPA	NPA	NPA
Area bisecting axis position	f _{y,0}	cm	NPA	NPA	NPA
	f _{z,0}	cm	NPA	NPA	NPA
Plastic shear forces	V _{pl,y,k}	kN	NPA	NPA	NPA
	V _{pl,z,k}	kN	NPA	NPA	NPA
Plastic axial forces	N _{pl,k}	kN	NPA	NPA	NPA
Buckling curves	BC _y	-	c	c	c
	BC _z	-	c	c	c

Hilti MT channels

Intended use
 Specifications

Annex B6

Table B5: Properties of the cross section of Hilti channels MT-30 S, MT-30, MT-30 S OC, MT-30 OC, MT-40 S, MT-40, MT-40 S OC, MT-40 OC, MT-40 T, MT-40 T OC, MT-40D S, MT-40D, MT-40D S OC and MT-40D OC

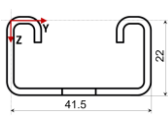
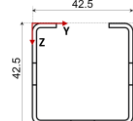
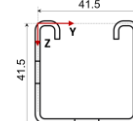
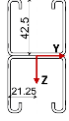
Description	Symbol	Unit	MT-30 S / MT-30 / MT-30 S OC / MT-30 OC	MT-40 T / MT-40 T OC	MT-40 S / MT-40 / MT-40 S OC / MT-40 OC	MT-40D S / MT-40D / MT-40D S OC / MT-40D OC
Cross section (Dimensions in mm and inch)	-	-				
Classification cross section in accordance with EN 1993-1-1	-	-	3	3	3	3
Cross section areas	A	cm ²	1.81	1.76	2.15	4.31
	A _{tot}	cm ²	1.81	1.76	2.15	4.31
Shear areas	A _y	cm ²	NPA	NPA	NPA	NPA
	A _z	cm ²	NPA	NPA	NPA	NPA
Centroid position	y _{C,0}	cm	2.02	2.13	2.02	0.00
	z _{C,0}	cm	1.10	2.30	2.07	0.00
Moments of inertia	I _y	cm ⁴	1.22	4.85	5.80	30.13
	I _z	cm ⁴	5.22	5.73	6.61	13.22
Polar moments of inertia	I _p	cm ⁴	6.43	10.58	12.41	43.35
	I _{p,M}	cm ⁴	16.42	40.93	55.83	43.35
Radii of gyration	i _y	cm	0.82	1.66	1.64	2.64
	i _z	cm	1.70	1.80	1.75	1.75
Polar radii of gyration	i _p	cm	1.89	2.45	2.40	3.17
	i _{p,M}	cm	3.01	4.82	5.10	3.17
Warping radius of gyration	i _{w,M}	cm	NPA	NPA	NPA	NPA
Torsional constant	J	cm ⁴	NPA	NPA	NPA	NPA
Secondary torsional constant	J _s	cm ⁴	NPA	NPA	NPA	NPA
Location of the shear center	y _{M,0}	cm	NPA	NPA	NPA	NPA
	z _{M,0}	cm	NPA	NPA	NPA	NPA
	y _M	cm	NPA	NPA	NPA	NPA
	z _M	cm	NPA	NPA	NPA	NPA
Warping constant	I _{w,C}	cm ⁶	NPA	NPA	NPA	NPA
	I _{w,M}	cm ⁶	NPA	NPA	NPA	NPA
Section moduli	S _{y,max}	cm ³	1.11	2.49	2.79	7.09
	S _{y,min}	cm ³	-1.01	-2.11	-2.67	-7.09
	S _{z,max}	cm ³	2.45	2.69	3.11	6.22
	S _{z,min}	cm ³	-2.45	-2.69	-3.11	-6.22
Torsional section modulus	S _t	cm ³	NPA	NPA	NPA	NPA
Max. plastic bending moment	M _{pl,y,k}	kNm	NPA	NPA	NPA	NPA
	M _{pl,z,k}	kNm	NPA	NPA	NPA	NPA
Max. plastic section moduli	Z _y	cm ³	NPA	NPA	NPA	NPA
	Z _z	cm ³	NPA	NPA	NPA	NPA
Plastic shear areas	A _{pl,y}	cm ²	NPA	NPA	NPA	NPA
	A _{pl,z}	cm ²	NPA	NPA	NPA	NPA
Area bisecting axis position	f _{y,0}	cm	NPA	NPA	NPA	NPA
	f _{z,0}	cm	NPA	NPA	NPA	NPA
Plastic shear forces	V _{pl,y,k}	kN	NPA	NPA	NPA	NPA
	V _{pl,z,k}	kN	NPA	NPA	NPA	NPA
Plastic axial forces	N _{pl,k}	kN	NPA	NPA	NPA	NPA
Buckling curves	BC _y	-	c	c	c	c
	BC _z	-	c	c	c	c

Hilti MT channels

Requirements for performance assessment

Annex B7

Table B6: Properties of the cross section of Hilti channels MT-50 S, MT-50 S OC, MT-50, MT-50 OC, MT-60 S, MT-60 S OC, MT-60, MT-60 OC, MT-70 S OC, MT-70 OC, MT-80 S OC and MT-80 OC

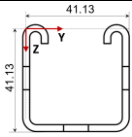
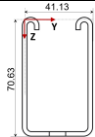
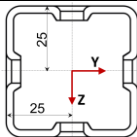
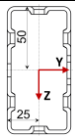
Description	Symbol	Unit	MT-50 S / MT-50 / MT-50 S OC / MT-50 OC	MT-60 S / MT-60 S OC / MT-60 / MT-60 OC	MT-70 S OC / MT-70 OC	MT-80 S OC / MT-80 OC
Cross section (Dimensions in mm and inch)	-	-				
Classification cross section in accordance with EN 1993-1-1	-	-	3	4	3	3
Cross section areas	A	cm ²	2.77	4.70	4.32	5.96
	A _{tot}	cm ²	2.77	4.70	4.32	5.96
Shear areas	A _y	cm ²	NPA	NPA	NPA	NPA
	A _z	cm ²	NPA	NPA	NPA	NPA
Centroid position	y _{C,0}	cm	1.99	1.99	0.00	0.00
	z _{C,0}	cm	2.07	3.66	0.00	0.00
Moments of inertia	I _y	cm ⁴	7.07	26.81	15.96	88.39
	I _z	cm ⁴	8.30	16.04	15.96	24.61
Polar moments of inertia	I _p	cm ⁴	15.36	42.85	31.93	113.00
	I _{p,M}	cm ⁴	66.91	267.95	31.93	113.00
Radii of gyration	i _y	cm	1.60	2.39	1.92	3.85
	i _z	cm	1.73	1.85	1.92	2.03
Polar radii of gyration	i _p	cm	2.35	3.02	2.72	4.36
	i _{p,M}	cm	4.91	7.55	2.72	4.36
Warping radius of gyration	i _{ω,M}	cm	NPA	NPA	NPA	NPA
Torsional constant	J	cm ⁴	NPA	NPA	NPA	NPA
Secondary torsional constant	J _s	cm ⁴	NPA	NPA	NPA	NPA
Location of the shear center	y _{M,0}	cm	NPA	NPA	NPA	NPA
	z _{M,0}	cm	NPA	NPA	NPA	NPA
	y _M	cm	NPA	NPA	NPA	NPA
	z _M	cm	NPA	NPA	NPA	NPA
Warping constant	I _{ω,C}	cm ⁶	NPA	NPA	NPA	NPA
	I _{ω,M}	cm ⁶	NPA	NPA	NPA	NPA
Section moduli	S _{y,max}	cm ³	3.46	7.89	6.39	17.68
	S _{y,min}	cm ³	-3.21	-7.09	-6.39	-17.68
	S _{z,max}	cm ³	3.90	7.55	6.39	9.84
	S _{z,min}	cm ³	-3.90	-7.55	-6.39	-9.84
Torsional section modulus	S _t	cm ³		NPA	NPA	NPA
Max. plastic bending moment	M _{pl,y,k}	kNm	NPA	NPA	NPA	NPA
	M _{pl,z,k}	kNm	NPA	NPA	NPA	NPA
Max. plastic section moduli	Z _y	cm ³	NPA	NPA	NPA	NPA
	Z _z	cm ³	NPA	NPA	NPA	NPA
Plastic shear areas	A _{pl,y}	cm ²	NPA	NPA	NPA	NPA
	A _{pl,z}	cm ²	NPA	NPA	NPA	NPA
Area bisecting axis position	f _{y,0}	cm	NPA	NPA	NPA	NPA
	f _{z,0}	cm	NPA	NPA	NPA	NPA
Plastic shear forces	V _{pl,y,k}	kN	NPA	NPA	NPA	NPA
	V _{pl,z,k}	kN	NPA	NPA	NPA	NPA
Plastic axial forces	N _{pl,k}	kN	NPA	NPA	NPA	NPA
Buckling curves	BC _y	-	c	c	c	c
	BC _z	-	c	c	c	c

Hilti MT channels

Requirements for performance assessment

Annex B8

Table B7: Properties of the cross section of Hilti channels MT-90 S OC, MT-90 OC, MT-100 S OC, MT-100 OC

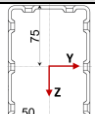
Description	Symbol	Unit	MT-90 S OC / MT-90 OC	MT-100 S OC / MT-100 OC
Cross section (Dimensions in mm and inch)	-	-		
Classification cross section in accordance with EN 1993-1-1	-	-	3	3
Cross section areas	A	cm ²	9.80	15.63
	A _{tot}	cm ²	9.80	15.63
Shear areas	A _y	cm ²	NPA	NPA
	A _z	cm ²	NPA	NPA
Centroid position	Y _{C,0}	cm	0.00	0.00
	Z _{C,0}	cm	0.00	0.00
Moments of inertia	I _y	cm ⁴	151.49	490.02
	I _z	cm ⁴	151.49	262.25
Polar moments of inertia	I _p	cm ⁴	302.97	752.27
	I _{p,M}	cm ⁴	302.97	752.27
Radii of gyration	i _y	cm	3.93	5.60
	i _z	cm	3.93	4.10
Polar radii of gyration	i _p	cm	5.56	6.94
	i _{p,M}	cm	5.56	6.94
Warping radius of gyration	i _{ω,M}	cm	NPA	NPA
Torsional constant	J	cm ⁴	NPA	NPA
Secondary torsional constant	J _s	cm ⁴	NPA	NPA
Location of the shear center	Y _{M,0}	cm	NPA	NPA
	Z _{M,0}	cm	NPA	NPA
	y _M	cm	NPA	NPA
	z _M	cm	NPA	NPA
Warping constants	I _{ω,C}	cm ⁶	NPA	NPA
	I _{ω,M}	cm ⁶	NPA	NPA
Section moduli	S _{y,max}	cm ³	30.30	65.34
	S _{y,min}	cm ³	-30.30	-65.34
	S _{z,max}	cm ³	30.30	52.45
	S _{z,min}	cm ³	-30.30	-52.45
Torsional section modulus	S _t	cm ³	NPA	NPA
Max. plastic bending moment	M _{pl,y,k}	kNm	NPA	NPA
	M _{pl,z,k}	kNm	NPA	NPA
Max. plastic section moduli	Z _y	cm ³	NPA	NPA
	Z _z	cm ³	NPA	NPA
Plastic shear areas	A _{pl,y}	cm ²	NPA	NPA
	A _{pl,z}	cm ²	NPA	NPA
Area bisecting axis position	f _{y,0}	cm	NPA	NPA
	f _{z,0}	cm	NPA	NPA
Plastic shear forces	V _{pl,y,k}	kN	NPA	NPA
	V _{pl,z,k}	kN	NPA	NPA
Plastic axial forces	N _{pl,k}	kN	NPA	NPA
Buckling curves	BC _y	-	c	c
	BC _z	-	c	c

Hilti MT channels

Requirements for performance assessment

Annex B9

Table C1: Pull-through resistance $F_{Rk,t}$ from the round holes in the back of the channels in case of fire

Anchor	Installation channel	Parameter of regression curve	Pull through resistance $F_{Rk,t}$ in N			
		$F_{Rk}(t) = c_3 (c_1 + c_2 / t)$	$F_{Rk,30}$	$F_{Rk,60}$	$F_{Rk,90}$	$F_{Rk,120}$
HUS3-P6 x L ^{*)} HUS4-H8 x L ^{*)} HST4-M10 x L ^{*)} M10 threaded rod + 10.5 washer	MT-30 MT-30 S MT-30 OC MT-30 S OC MT-40 MT-40 S MT-40 OC MT-40 S OC MT-40D MT-40D S MT-40D OC MT-40D S OC MT-50 MT-50 S MT-50 OC MT-50 S OC	$c_1 = 971,5536$ $c_2 = 34991,5717$ $c_3 = 0,71824$ $22 \text{ min} \leq t \leq 130 \text{ min}$	1535,6	1116,7	997,1	907,2

^{*)} L = length of anchors, see manufacturers brochures.

Designation

$F_{Rk,t}$ Resistance after an exposure time t in case of fire [N]
 $F_{Rk}(t)$ Resistance time function in case of fire [N]

Hilti anchors for channel fixation

Characteristic pull-through resistance in case of fire

Annex C1

Table C2: Pull-through resistance $F_{Rk,t}$ of MQZ-L drilled plates through slotted holes in the back of the channels in case of fire

Drilled plates	Installation channel	Parameter of regression curve	Pull through resistance $F_{Rk,t}$ in N			
		$F_{Rk}(t) = c_3 (c_1 + c_2 / t)$	$F_{Rk,30}$	$F_{Rk,60}$	$F_{Rk,90}$	$F_{Rk,120}$
MQZ-L11 MQZ-L13	MT-30 MT-30 S MT-30 OC MT-30 S OC MT-40 MT-40 S MT-40 OC MT-40 S OC MT-40D MT-40D S MT-40D OC MT-40D S OC MT-50 MT-50 S MT-50 OC MT-50 S OC	$c_1 = 427,2416$ $c_2 = 130158,0662$ $c_3 = 0,910073$ $33 \text{ min} \leq t \leq 130 \text{ min}$	2168,65	1181,5	852,5	687,95

Designation





$F_{Rk,t}$ Resistance after an exposure time t in case of fire [N]
 $F_{Rk}(t)$ Resistance time function in case of fire [N]

Hilti MQZ-L drilled plates

Characteristic pull-through resistance in case of fire

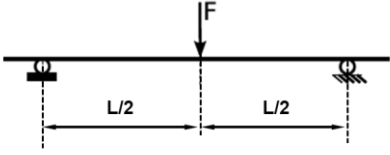
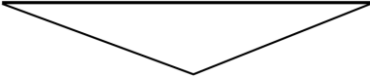
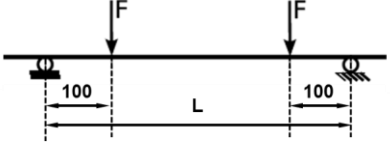
Annex C2

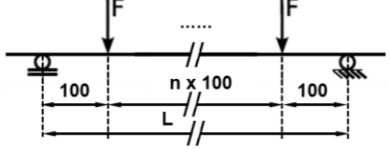
Table D19: Loading characteristics of Hilti channels

Loadcase	System	Resulting torque curve shape
1		
2		
3		

Symbols and designation



- L Distance between the supports in mm
- n number of 100 mm gaps between loads
- F Load

Hilti MT installation channels

Bending characteristics of the channel in case of fire

Annex D1

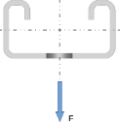
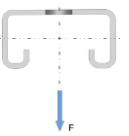
Table D20: Calculation-based deformation in case of fire for installation channels MT-30, MT-30 S, MT-30 OC and MT-30 S OC

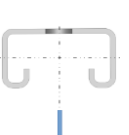
System			Load direction	σ_B	$V^{1)}$	$F^{2)}$	$\delta_{t_{max};B}$	$t_{max,B}$	δ_{30}	δ_{60}	δ_{90}	δ_{120}
Loadcase	$L^3)$	n		MPa	-	N	mm	min	mm	mm	mm	mm
1	300	-		5	0,50	65,69	12,03	120,00	12,03	12,03	12,03	12,03
				10	0,50	133,47	22,23	120,00	13,21	14,03	16,61	22,23
				15	0,50	201,24	43,04	120,00	14,75	19,22	29,00	43,04
				20	0,50	269,02	68,57	120,00	16,30	25,55	44,79	68,57
				25	0,50	336,80	90,40	120,00	17,92	33,17	62,02	90,40
				30	0,50	404,58	104,49	120,00	19,77	42,43	79,77	104,49
1	300	-		5	0,50	65,69	12,15	120,00	12,15	12,15	12,15	12,15
				10	0,50	133,47	26,38	120,00	13,54	14,98	18,84	26,38
				15	0,50	201,24	56,39	120,00	15,24	20,89	34,63	56,39
				20	0,50	269,02	76,00	100,00	17,00	28,40	57,33	-
				25	0,50	336,80	45,84	66,67	18,88	38,20	-	-
				30	0,50	404,58	52,03	60,00	21,05	52,03	-	-
2 / 3	300	1		5	0,67	49,27	12,30	120,00	12,30	12,30	12,30	12,30
				10	0,67	100,10	40,58	120,00	14,03	16,98	24,66	40,58
				15	0,67	150,93	88,84	120,00	16,06	25,21	53,29	88,84
				20	0,67	201,77	108,13	120,00	18,13	37,20	91,35	108,13
				25	0,67	252,60	111,26	120,00	20,67	58,86	100,51	111,26
				30	0,67	303,43	113,86	120,00	24,11	80,63	105,77	113,86
2 / 3	300	1		5	0,67	49,27	12,38	120,00	12,38	12,38	12,38	12,38
				10	0,67	100,10	38,30	120,00	14,23	17,44	25,20	38,30
				15	0,67	150,93	71,97	120,00	16,36	25,77	48,27	71,97
				20	0,67	201,77	104,92	120,00	18,55	37,17	71,75	104,92
				25	0,67	252,60	116,31	120,00	21,22	52,59	94,32	116,31
				30	0,67	303,43	120,47	120,00	24,70	70,86	106,36	120,47

¹⁾ Momentum degree of fullness without contribution from channel dead weight

²⁾ Size of designated system's single load

³⁾ Dimensions in mm and inch

Symbols and designation

- ϵ_{B,θ_a} Channel bending strain at elevated temperatures θ_a
- σ_B Channel bending stress
- V Momentum degree of fullness
- F Load
- $\delta_{t_{max};B}$ Deformation of the channel at the point in time of stability failure or of the plastic hinging
- $t_{max,B}$ Time in which loss of rigidity or plastic hinging of the channel occurs under bending stress
- δ_{30} Displacement after exposure time of 30 minutes to elevated temperatures
- δ_{60} Displacement after exposure time of 60 minutes to elevated temperatures
- δ_{90} Displacement after exposure time of 90 minutes to elevated temperatures
- δ_{120} Displacement after exposure time of 120 minutes to elevated temperatures

Thermal analyses as well as calculations are referring to the boundary conditions of STTC.

Hilti MT installation channels

Bending characteristics of the channel in case of fire

Annex D2

Table D21: Calculation-based deformation in case of fire for installation channels MT-30, MT-30 S, MT-30 OC and MT-30 S OC

System			Load direction	σ_B MPa	$V^{1)}$ -	$F^{2)}$ N	$\delta_{t_{max},B}$ mm	$t_{max,B}$ min	δ_{30} mm	δ_{60} mm	δ_{90} mm	δ_{120} mm
Loadcase	$L^3)$	n										
1	500	-		5	0,50	37,18	24,77	120,00	13,78	15,84	20,42	24,77
				10	0,50	77,85	59,18	120,00	17,03	26,52	44,24	59,18
				15	0,50	118,52	100,97	120,00	21,16	40,40	73,37	100,97
				20	0,50	159,18	142,76	120,00	25,35	56,88	103,87	142,76
				25	0,50	199,85	178,58	120,00	29,80	75,06	131,94	178,58
				30	0,50	240,52	191,69	120,00	35,00	94,43	161,25	191,69
1	500	-		5	0,50	37,18	25,93	120,00	13,89	16,21	21,31	25,93
				10	0,50	77,85	65,50	120,00	17,37	27,69	47,57	65,50
				15	0,50	118,52	121,73	120,00	21,69	42,84	81,15	121,73
				20	0,50	159,18	142,64	100,00	26,15	61,33	122,05	-
				25	0,50	199,85	113,38	73,33	30,98	82,60	-	-
				30	0,50	240,52	127,84	66,67	36,72	107,29	-	-
2	500	-		5	0,80	46,48	35,05	120,00	14,87	19,48	28,74	35,05
				10	0,80	97,31	106,99	120,00	20,42	38,33	70,22	106,99
				15	0,80	148,15	162,42	120,00	26,75	61,80	122,64	162,42
				20	0,80	198,98	181,97	120,00	33,16	88,40	157,42	181,97
				25	0,80	249,81	186,83	120,00	41,37	127,50	172,98	186,83
				30	0,80	300,65	191,24	120,00	52,07	153,03	180,82	191,24
2	500	-		5	0,80	46,48	35,03	120,00	14,89	19,52	28,74	35,03
				10	0,80	97,31	90,19	120,00	20,49	38,12	67,44	90,19
				15	0,80	148,15	131,24	120,00	26,81	60,77	106,95	131,24
				20	0,80	198,98	177,45	120,00	33,19	84,42	156,77	177,45
				25	0,80	249,81	186,95	120,00	41,10	107,18	170,60	186,95
				30	0,80	300,65	193,19	120,00	51,13	143,98	180,14	193,19
3	500	3		5	0,67	15,49	31,73	120,00	14,52	18,30	26,03	31,73
				10	0,67	32,44	84,32	120,00	19,18	33,93	60,56	84,32
				15	0,67	49,38	161,52	120,00	24,69	54,17	101,12	161,52
				20	0,67	66,33	187,22	120,00	30,24	77,47	157,22	187,22
				25	0,67	83,27	199,19	120,00	36,84	103,26	179,64	199,19
				30	0,67	100,22	207,27	120,00	45,36	140,95	192,44	207,27
3	500	3		5	0,67	15,49	31,74	120,00	14,53	18,33	26,07	31,74
				10	0,67	32,44	82,25	120,00	19,26	34,07	60,36	82,25
				15	0,67	49,38	124,65	120,00	24,84	54,12	96,57	124,65
				20	0,67	66,33	166,73	120,00	30,42	76,51	130,16	166,73
				25	0,67	83,27	185,55	120,00	36,97	99,56	155,21	185,55
				30	0,67	100,22	197,65	120,00	45,31	120,08	174,81	197,65

¹⁾ Momentum degree of fullness without contribution from channel dead weight

²⁾ Size of designated system's single load

³⁾ Dimensions in mm and inch

Symbols and designation see Annex D1

Hilti MT installation channels

Bending characteristics of the channel in case of fire

Annex D3

Table D22: Calculation-based deformation in case of fire for installation channels MT-30, MT-30 S, MT-30 OC and MT-30 S OC

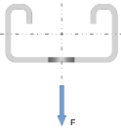
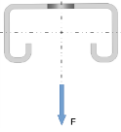
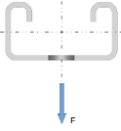
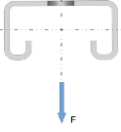
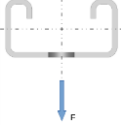
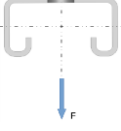
System			Load direction	σ_B	$V^{1)}$	$F^{2)}$	$\delta_{t_{max},B}$	$t_{max,B}$	δ_{30}	δ_{60}	δ_{90}	δ_{120}
Loadcase	$L^3)$	n		MPa	-	N	mm	min	mm	mm	mm	mm
1	700	-		5	0,50	24,17	48,85	120	16,54	24,78	40,11	48,85
				10	0,50	53,22	107,18	120	22,95	45,47	83,06	107,18
				15	0,50	82,27	167,86	120	31,01	71,47	128,69	167,86
				20	0,50	111,32	232,67	120	39,13	99,74	171,01	232,67
				25	0,50	140,36	261,63	120	47,67	128,05	213,55	261,63
				30	0,50	169,41	276,65	120	57,65	155,32	245,41	276,65
1	700	-		5	0,50	24,17	49,88	120	16,61	25,02	40,86	49,88
				10	0,50	53,22	113,53	120	23,20	46,60	86,49	113,53
				15	0,50	82,27	178,05	120	31,49	73,99	135,88	178,05
				20	0,50	111,32	211,04	106,67	39,87	104,32	181,63	0,00
				25	0,50	140,36	219,3	86,67	48,84	135,31	-	-
				30	0,50	169,41	207,99	73,33	59,44	165,64	-	-
2	700	-		5	0,86	42,3	66,68	120	18,64	31,77	55,09	66,68
				10	0,86	93,13	161,33	120	29,89	67,72	115,44	161,33
				15	0,86	143,97	222,62	120	42,56	104,84	179,38	222,62
				20	0,86	194,8	242,38	120	55,17	138,96	211,48	242,38
				25	0,86	245,64	237,22	120	70,51	179,8	221,51	237,22
				30	0,86	296,47	242,94	120	88,71	202,98	231,52	242,94
2	700	-		5	0,86	42,3	65,55	120	18,59	31,48	54,23	65,55
				10	0,86	93,13	133,79	120	29,7	65,91	111,12	133,79
				15	0,86	143,97	179,74	120	42,13	100,7	152,24	179,74
				20	0,86	194,8	236,52	120	54,27	130,4	207,38	236,52
				25	0,86	245,64	246,03	120	68,36	153,58	224,33	246,03
				30	0,86	296,47	252,16	120	84,89	173,37	235,27	252,16
3	700	5		5	0,67	7,05	61,33	120	18,05	29,68	50,54	61,33
				10	0,67	15,52	131,71	120	27,18	59	104,47	131,71
				15	0,67	23,99	184,84	120	37,81	92,05	149,19	184,84
				20	0,67	32,47	241,07	120	48,36	123,77	186,22	241,07
				25	0,67	40,94	267,77	120	60,46	152,09	219,72	267,77
				30	0,67	49,41	281,46	120	75,04	176,76	249,36	281,46
3	700	5		5	0,67	7,05	60,2	120	17,88	29,16	49,57	60,20
				10	0,67	15,52	131,64	120	26,93	58,2	104,17	131,64
				15	0,67	23,99	183,85	120	37,55	91,47	150,05	183,85
				20	0,67	32,47	217,3	120	48,02	123,74	185,45	217,30
				25	0,67	40,94	242,20	120	59,9	152,26	211,45	242,20
				30	0,67	49,41	260,81	120	74,26	176,42	232,05	260,81

¹⁾ Momentum degree of fullness without contribution from channel dead weight

²⁾ Size of designated system's single load

³⁾ Dimensions in mm and inch

Symbols and designation see Annex D1

Hilti MT installation channels

Bending characteristics of the channel in case of fire

Annex D4

Table D23: Calculation-based deformation in case of fire for installation channels MT-30, MT-30 S, MT-30 OC and MT-30 S OC

System			Load direction	σ_B	$V^{1)}$	$F^{2)}$	$\delta_{t_{max},B}$	$t_{max,B}$	δ_{30}	δ_{60}	δ_{90}	δ_{120}
Loadcase	$L^3)$	n		MPa	-	N	mm	min	mm	mm	mm	mm
1	900	-		5	0,50	16,32	81,17	120,00	20,44	37,27	66,89	81,17
				10	0,50	38,92	162,08	120,00	31,11	70,95	130,43	162,08
				15	0,50	61,51	238,77	120,00	44,36	110,76	189,86	238,77
				20	0,50	84,10	312,81	120,00	57,58	150,49	241,50	312,81
				25	0,50	106,69	344,89	120,00	71,35	187,18	292,21	344,89
				30	0,50	129,29	362,39	120,00	87,16	220,63	325,98	362,39
1	900	-		5	0,50	16,32	82,19	120,00	20,45	37,44	67,63	82,19
				10	0,50	38,92	168,04	120,00	31,33	72,25	133,98	168,04
				15	0,50	61,51	244,11	120,00	44,88	113,56	196,03	244,11
				20	0,50	84,10	304,09	120,00	58,43	155,18	247,98	304,09
				25	0,50	106,69	310,91	100,00	72,75	193,84	288,41	-
				30	0,50	129,29	319,97	86,67	89,33	228,91	-	-
2	900	-		5	0,89	36,73	103,12	120,00	23,51	47,39	86,29	103,12
				10	0,89	87,56	200,41	120,00	42,18	101,73	162,23	200,41
				15	0,89	138,40	253,12	120,00	62,98	149,50	215,52	253,12
				20	0,89	189,23	277,67	120,00	83,02	188,18	249,78	277,67
				25	0,89	240,06	291,24	120,00	105,52	220,40	269,41	291,24
				30	0,89	290,90	299,69	120,00	130,67	243,19	282,26	299,69
2	900	-		5	0,89	36,73	101,33	120,00	23,39	46,80	84,90	101,33
				10	0,89	87,56	179,16	120,00	41,69	98,58	156,53	179,16
				15	0,89	138,40	225,03	120,00	61,96	143,30	200,91	225,03
				20	0,89	189,23	259,46	120,00	81,08	177,17	228,72	259,46
				25	0,89	240,06	299,64	120,00	101,57	201,98	248,09	299,64
				30	0,89	290,90	309,09	120,00	124,26	220,60	262,32	309,09
3	900	9		5	0,67	3,67	99,15	120,00	23,08	45,73	82,79	99,15
				10	0,67	8,76	182,18	120,00	38,37	91,14	152,76	182,18
				15	0,67	13,84	238,42	120,00	55,54	135,50	203,10	238,42
				20	0,67	18,92	275,71	120,00	72,26	173,70	239,71	275,71
				25	0,67	24,01	306,13	120,00	90,60	204,63	268,36	306,13
				30	0,67	29,09	341,64	120,00	111,52	230,48	291,65	341,64
3	900	9		5	0,67	3,67	97,14	120,00	22,59	44,25	80,76	97,14
				10	0,67	8,76	185,15	120,00	37,60	89,77	154,22	185,15
				15	0,67	13,84	245,04	120,00	54,79	135,97	207,98	245,04
				20	0,67	18,92	281,80	120,00	71,49	176,24	246,51	281,80
				25	0,67	24,01	306,87	120,00	89,79	208,80	275,26	306,87
				30	0,67	29,09	326,28	120,00	110,88	235,72	296,86	326,28

¹⁾ Momentum degree of fullness without contribution from channel dead weight

²⁾ Size of designated system's single load

³⁾ Dimensions in mm and inch





Symbols and designation see Annex D1

Hilti MT installation channels

Bending characteristics of the channel in case of fire

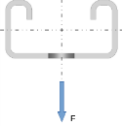
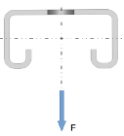
Annex D5

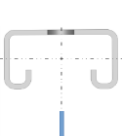
Table D24: Calculation-based deformation in case of fire for installation channels MT-30, MT-30 S, MT-30 OC and MT-30 S OC

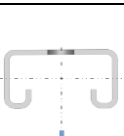
System			Load direction	σ_B	$V^{1)}$	$F^{2)}$	$\delta_{t_{max},B}$	$t_{max,B}$	δ_{30}	δ_{60}	δ_{90}	δ_{120}
Loadcase	$L^{3)}$	n		MPa	-	N	mm	min	mm	mm	mm	mm
1	1100	-		5	0,50	10,82	121,25	120,00	25,61	53,72	100,77	121,25
				10	0,50	29,31	221,36	120,00	41,65	102,64	183,83	221,36
				15	0,50	47,79	310,11	120,00	61,33	156,61	254,91	310,11
				20	0,50	66,28	392,70	120,00	80,74	206,59	312,74	392,70
				25	0,50	84,76	429,13	120,00	100,63	250,17	369,51	429,13
				30	0,50	103,25	448,96	120,00	122,89	288,51	407,48	448,96
1	1100	-		5	0,50	10,82	122,14	120,00	25,55	53,79	101,39	122,14
				10	0,50	29,31	226,42	120,00	41,84	104,00	187,14	226,42
				15	0,50	47,79	312,76	120,00	61,89	159,42	259,92	312,76
				20	0,50	66,28	369,75	120,00	81,71	211,01	317,00	369,75
				25	0,50	84,76	420,46	120,00	102,22	255,85	361,16	420,46
				30	0,50	103,25	412,98	100,00	125,34	295,02	395,20	-
2	1100	-		5	0,91	29,76	142,03	120,00	29,32	65,56	120,27	142,03
				10	0,91	80,60	248,82	120,00	56,88	138,17	209,95	248,82
				15	0,91	131,43	306,44	120,00	87,24	195,00	265,98	306,44
				20	0,91	182,26	334,88	120,00	115,45	237,58	302,52	334,88
				25	0,91	233,10	351,66	120,00	144,95	270,21	325,56	351,66
				30	0,91	283,93	363,14	120,00	176,36	294,06	341,48	363,14
2	1100	-		5	0,91	29,76	140,43	120,00	29,13	64,84	118,98	140,43
				10	0,91	80,60	228,49	120,00	56,09	134,19	204,50	228,49
				15	0,91	131,43	277,05	120,00	85,61	187,99	253,39	277,05
				20	0,91	182,26	304,61	120,00	112,37	225,43	283,23	304,61
				25	0,91	233,10	321,78	120,00	139,31	252,54	303,29	321,78
				30	0,91	283,93	333,02	120,00	167,84	272,58	317,40	333,02
3	1100	9		5	0,67	1,98	143,55	120,00	29,95	67,04	121,73	143,55
				10	0,67	5,37	234,36	120,00	53,00	128,74	203,56	234,36
				15	0,67	8,76	295,00	120,00	77,92	182,24	259,21	295,00
				20	0,67	12,15	334,67	120,00	101,65	225,26	297,80	334,67
				25	0,67	15,54	363,40	120,00	126,48	259,09	327,42	363,40
				30	0,67	18,93	385,92	120,00	153,50	286,36	350,97	385,92
3	1100	9		5	0,67	1,98	140,86	120,00	28,81	63,85	118,62	140,86
				10	0,67	5,37	240,99	120,00	51,29	127,12	207,70	240,99
				15	0,67	8,76	307,46	120,00	76,44	184,66	268,69	307,46
				20	0,67	12,15	348,73	120,00	100,39	231,31	310,14	348,73
				25	0,67	15,54	376,80	120,00	125,56	267,73	341,25	376,80
				30	0,67	18,93	397,09	120,00	153,59	296,81	364,96	397,09

¹⁾ Momentum degree of fullness without contribution from channel dead weight

²⁾ Size of designated system's single load

³⁾ Dimensions in mm and inch





Symbols and designation see Annex D1

Hilti MT installation channels

Bending characteristics of the channel in case of fire

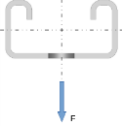
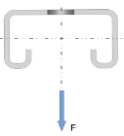
Annex D6

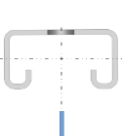
Table D25: Calculation-based deformation in case of fire for installation channels MT-30, MT-30 S, MT-30 OC and MT-30 S OC

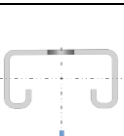
System			Load direction	σ_B	$V^{1)}$	$F^{2)}$	$\delta_{t_{max},B}$	$t_{max,B}$	δ_{30}	δ_{60}	δ_{90}	δ_{120}
Loadcase	$L^3)$	n		MPa	-	N	mm	min	mm	mm	mm	mm
1	1300	-		5	0,50	6,59	168,28	120,00	32,25	74,60	141,39	168,28
				10	0,50	22,23	283,86	120,00	54,84	140,29	241,83	283,86
				15	0,50	37,87	381,06	120,00	82,11	207,64	322,76	381,06
				20	0,50	53,51	471,73	120,00	108,55	266,47	384,66	471,73
				25	0,50	69,15	514,45	120,00	135,23	315,84	445,11	514,45
				30	0,50	84,79	536,28	120,00	164,21	358,05	489,44	536,28
1	1300	-		5	0,50	6,59	168,85	120,00	32,10	74,51	141,74	168,85
				10	0,50	22,23	287,81	120,00	54,97	141,54	244,67	287,81
				15	0,50	37,87	383,07	120,00	82,69	210,26	326,95	383,07
				20	0,50	53,51	444,72	120,00	109,60	270,41	388,27	444,72
				25	0,50	69,15	489,87	120,00	136,95	320,66	435,95	489,87
				30	0,50	84,79	513,98	113,33	166,79	363,31	472,22	-
2	1300	-		5	0,92	21,41	182,49	120,00	35,88	85,55	155,94	182,49
				10	0,92	72,24	289,66	120,00	73,51	176,16	259,73	289,66
				15	0,92	123,07	362,73	120,00	115,18	241,69	318,74	362,73
				20	0,92	173,91	396,90	120,00	151,36	286,93	356,90	396,90
				25	0,92	224,74	417,33	120,00	187,92	320,56	382,43	417,33
				30	0,92	275,57	430,64	120,00	224,10	345,03	399,75	430,64
2	1300	-		5	0,92	21,41	182,17	120,00	35,64	84,98	155,59	182,17
				10	0,92	72,24	282,31	120,00	72,52	172,01	255,26	282,31
				15	0,92	123,07	334,13	120,00	113,00	234,72	309,25	334,13
				20	0,92	173,91	363,43	120,00	147,15	275,57	341,19	363,43
				25	0,92	224,74	381,80	120,00	180,75	305,08	362,69	381,80
				30	0,92	275,57	393,97	120,00	213,65	326,95	377,83	393,97
3	1300	11		5	0,67	1,02	193,11	120,00	39,14	94,27	166,31	193,11
				10	0,67	3,44	288,54	120,00	71,58	170,77	256,38	288,54
				15	0,67	5,86	351,99	120,00	104,96	231,02	315,80	351,99
				20	0,67	8,28	394,78	120,00	136,02	277,50	357,26	394,78
				25	0,67	10,70	425,69	120,00	167,72	313,91	388,38	425,69
				30	0,67	13,12	449,28	120,00	200,26	343,09	413,17	449,28
3	1300	11		5	0,67	1,02	190,31	120,00	36,81	88,47	162,43	190,31
				10	0,67	3,44	299,44	120,00	68,37	169,45	264,09	299,44
				15	0,67	5,86	370,82	120,00	102,50	236,35	330,97	370,82
				20	0,67	8,28	416,19	120,00	134,29	288,06	375,84	416,19
				25	0,67	10,70	447,28	120,00	166,93	327,99	408,83	447,28
				30	0,67	13,12	469,94	120,00	201,07	359,44	434,37	469,94

¹⁾ Momentum degree of fullness without contribution from channel dead weight

²⁾ Size of designated system's single load

³⁾ Dimensions in mm and inch

Symbols and designation see Annex D1

Hilti MT installation channels

Bending characteristics of the channel in case of fire

Annex D7

Table D26: Calculation-based deformation in case of fire for installation channels MT-40, MT-40 S, MT-40 OC and MT-40 S OC

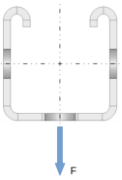
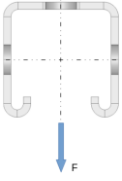
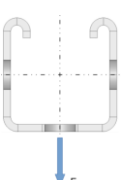
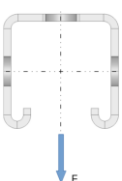
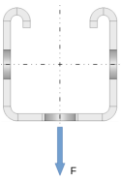
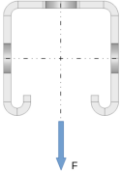
System			Load direction	σ_B	$V^{(1)}$	$F^{(2)}$	$\delta_{t_{max},B}$	$t_{max,B}$	δ_{30}	δ_{60}	δ_{90}	δ_{120}
Loadcase	$L^{(3)}$	n		MPa	-	N	mm	min	mm	mm	mm	mm
1	500	-		5	0,50	102,77	14,27	120,00	5,98	11,19	14,27	14,27
				10	0,50	209,68	22,33	120,00	8,44	17,10	22,33	22,33
				15	0,50	316,59	35,91	120,00	11,05	24,32	35,73	35,91
				20	0,50	423,50	115,16	120,00	14,48	34,17	75,97	115,16
				25	0,50	530,42	141,80	120,00	20,41	96,85	132,55	141,80
				30	0,50	637,33	159,48	120,00	49,13	122,99	151,91	159,48
1	500	-		5	0,50	102,77	14,46	120,00	6,07	11,36	14,46	14,46
				10	0,50	209,68	22,92	120,00	8,61	17,52	22,92	22,92
				15	0,50	316,59	36,03	120,00	11,37	24,92	36,03	36,03
				20	0,50	423,50	58,42	86,67	14,99	34,01	-	-
				25	0,50	530,42	45,10	46,67	21,02	-	-	-
				30	0,50	637,33	18,88	26,67	-	-	-	-
2	500	-		5	0,80	128,46	16,06	120,00	6,85	12,85	16,06	16,06
				10	0,80	262,10	33,83	93,33	10,34	22,56	33,28	-
				15	0,80	395,74	8,95	26,67	-	-	-	-
				20	0,80	529,38	12,80	26,67	-	-	-	-
				25	0,80	663,02	6,25	20,00	-	-	-	-
				30	0,80	796,66	8,54	20,00	-	-	-	-
2	500	-		5	0,80	0,67	128,46	16,17	120,00	6,91	12,96	16,17
				10	0,80	0,67	262,10	31,39	120,00	10,49	22,86	31,39
				15	0,80	0,67	395,74	57,07	113,33	14,57	32,85	51,38
				20	0,80	0,67	529,38	50,83	60,00	21,32	50,83	-
				25	0,80	0,67	663,02	51,74	33,33	36,48	-	-
				30	0,80	0,67	796,66	39,49	26,67	-	-	-
3	500	3		5	0,67	0,80	42,82	15,48	120,00	6,57	12,32	15,48
				10	0,67	0,80	87,37	42,60	100,00	9,75	21,23	34,97
				15	0,67	0,80	131,91	25,50	40,00	13,67	-	-
				20	0,67	0,80	176,46	11,55	26,67	-	-	-
				25	0,67	0,80	221,01	5,60	20,00	-	-	-
				30	0,67	0,80	265,55	7,41	20,00	-	-	-
3	500	3		5	0,67	0,80	42,82	15,55	120,00	6,61	12,38	15,55
				10	0,67	0,80	87,37	28,06	120,00	9,80	20,83	28,06
				15	0,67	0,80	131,91	50,30	106,67	13,32	29,96	46,55
				20	0,67	0,80	176,46	47,12	60,00	18,73	47,12	-
				25	0,67	0,80	221,01	17,32	26,67	-	-	-
				30	0,67	0,80	265,55	32,10	26,67	-	-	-

¹⁾ Momentum degree of fullness without contribution from channel dead weight

²⁾ Size of designated system's single load

³⁾ Dimensions in mm and inch

Symbols and designation see Annex D1

Hilti MT installation channels

Bending characteristics of the channel in case of fire

Annex D8

Table D27: Calculation-based deformation in case of fire for installation channels MT-40, MT-40 S, MT-40 OC and MT-40 S OC

System			Load direction	σ_B	$V^{1)}$	$F^{2)}$	$\delta_{t_{max},B}$	$t_{max,B}$	δ_{30}	δ_{60}	δ_{90}	δ_{120}
Loadcase	L ³⁾	n		MPa	-	N	mm	min	mm	mm	mm	mm
1	700	-		5	0,50	70,56	18,73	120,00	8,22	15,38	18,73	18,73
				10	0,50	146,93	34,64	120,00	12,92	26,90	34,64	34,64
				15	0,50	223,29	109,06	120,00	17,96	40,64	61,44	109,06
				20	0,50	299,66	165,36	120,00	24,61	77,92	149,10	165,36
				25	0,50	376,03	197,18	120,00	57,97	131,91	183,96	197,18
				30	0,50	452,39	229,01	120,00	91,33	185,90	218,83	229,01
1	700	-		5	0,50	70,56	18,85	120,00	8,28	15,49	18,85	18,85
				10	0,50	146,93	34,83	120,00	13,03	27,12	34,83	34,83
				15	0,50	223,29	63,97	120,00	18,12	40,75	58,79	63,97
				20	0,50	299,66	89,80	86,67	24,72	56,91	-	-
				25	0,50	376,03	82,96	53,33	35,59	-	-	-
				30	0,50	452,39	32,71	26,67	-	-	-	-
2	700	-		5	0,86	123,49	22,54	120,00	10,07	18,92	22,54	22,54
				10	0,86	257,13	87,95	106,67	17,07	41,40	78,41	-
				15	0,86	390,77	14,65	26,67	-	-	-	-
				20	0,86	524,41	24,08	26,67	-	-	-	-
				25	0,86	658,05	10,10	20,00	-	-	-	-
				30	0,86	791,69	14,92	20,00	-	-	-	-
2	700	-		5	0,86	123,49	22,53	120,00	10,09	18,93	22,53	22,53
				10	0,86	257,13	51,78	120,00	17,13	38,33	51,78	51,78
				15	0,86	390,77	90,78	120,00	24,97	56,47	83,20	90,78
				20	0,86	524,41	111,88	86,67	37,21	79,01	-	-
				25	0,86	658,05	102,42	53,33	56,57	-	-	-
				30	0,86	791,69	108,72	40,00	82,15	-	-	-
3	700	5		5	0,67	20,58	21,18	120,00	9,38	17,62	21,18	21,18
				10	0,67	42,85	65,63	106,67	15,50	35,22	54,63	-
				15	0,67	65,13	58,24	46,67	23,20	-	-	-
				20	0,67	87,40	19,68	26,67	-	-	-	-
				25	0,67	109,67	8,61	20,00	-	-	-	-
				30	0,67	131,95	12,36	20,00	-	-	-	-
3	700	5		5	0,67	20,58	21,00	120,00	9,34	17,50	21,00	21,00
				10	0,67	42,85	44,78	120,00	15,37	33,56	44,78	44,78
				15	0,67	65,13	92,43	113,33	21,98	50,66	78,18	-
				20	0,67	87,40	93,01	66,67	31,98	78,07	-	-
				25	0,67	109,67	29,65	26,67	-	-	-	-
				30	0,67	131,95	55,37	26,67	-	-	-	-

¹⁾ Momentum degree of fullness without contribution from channel dead weight

²⁾ Size of designated system's single load

³⁾ Dimensions in mm and inch

Symbols and designation see Annex D1

Hilti MT installation channels

Bending characteristics of the channel in case of fire

Annex D9

Table D28: Calculation-based deformation in case of fire for installation channels MT-40, MT-40 S, MT-40 OC and MT-40 S OC

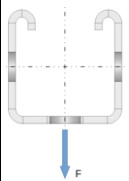
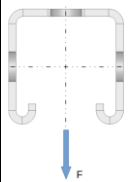
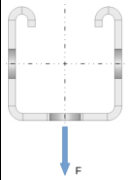
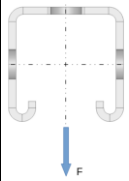
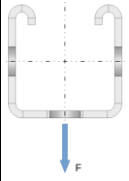
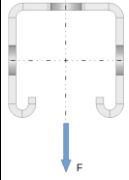
System			Load direction	σ_B	$V^{(1)}$	$F^{(2)}$	$\delta_{t_{max},B}$	$t_{max,B}$	δ_{30}	δ_{60}	δ_{90}	δ_{120}
Loadcase	L ⁽³⁾	n		MPa	-	N	mm	min	mm	mm	mm	mm
1	900	-		5	0,50	51,94	24,99	120,00	11,35	21,25	24,99	24,99
				10	0,50	111,33	51,35	120,00	19,05	40,19	51,35	51,35
				15	0,50	170,73	175,90	120,00	27,28	62,37	140,45	175,90
				20	0,50	230,12	202,00	120,00	47,70	100,20	170,82	202,00
				25	0,50	289,52	241,15	120,00	78,33	156,93	216,37	241,15
				30	0,50	348,91	306,39	120,00	129,38	251,49	292,29	306,39
1	-	-		5	0,50	51,94	24,99	120,00	11,36	21,27	24,99	24,99
				10	0,50	111,33	51,07	120,00	19,08	40,18	51,07	51,07
				15	0,50	170,73	98,86	120,00	27,26	61,73	87,85	98,86
				20	0,50	230,12	149,48	100,00	37,73	85,61	130,73	-
				25	0,50	289,52	125,25	60,00	54,24	125,25	-	-
				30	0,50	348,91	51,14	26,67	-	-	-	-
2	900	-		5	0,89	116,85	31,18	120,00	14,33	26,95	31,18	31,18
				10	0,89	250,49	128,51	120,00	35,45	84,17	118,98	128,51
				15	0,89	384,13	22,23	26,67	-	-	-	-
				20	0,89	517,77	10,48	20,00	-	-	-	-
				25	0,89	651,41	15,32	20,00	-	-	-	--
				30	0,89	785,05	27,35	20,00	-	-	-	-
2	900	-		5	0,89	116,85	30,98	120,00	14,32	26,86	30,98	30,98
				10	0,89	250,49	77,40	120,00	25,86	57,72	75,92	77,40
				15	0,89	384,13	123,94	120,00	38,24	84,40	116,21	123,94
				20	0,89	517,77	160,76	120,00	56,05	109,13	146,35	160,76
				25	0,89	651,41	154,66	73,33	81,04	135,60	-	-
				30	0,89	785,05	158,64	60,00	109,94	158,64	-	-
3	900	7		5	0,67	11,69	29,19	120,00	13,30	25,04	29,19	29,19
				10	0,67	25,05	99,35	120,00	23,36	53,83	78,83	99,35
				15	0,67	38,41	86,96	53,33	35,75	-	-	-
				20	0,67	51,78	30,37	26,67	-	-	-	-
				25	0,67	65,14	73,71	26,67	-	-	-	-
				30	0,67	78,51	18,82	20,00	-	-	-	-
3	900	7		5	0,67	11,69	28,59	120,00	13,13	24,63	28,59	28,59
				10	0,67	25,05	68,59	120,00	22,95	50,89	67,47	68,59
				15	0,67	38,41	148,66	120,00	33,67	78,07	118,19	148,66
				20	0,67	51,78	132,52	66,67	49,68	117,14	-	-
				25	0,67	65,14	116,32	33,33	81,36	-	-	-
				30	0,67	78,51	85,24	26,67	-	-	-	-

¹⁾ Momentum degree of fullness without contribution from channel dead weight

²⁾ Size of designated system's single load

³⁾ Dimensions in mm and inch

Symbols and designation see Annex D1

Hilti MT installation channels

Bending characteristics of the channel in case of fire

Annex D10

Table D29: Calculation-based deformation in case of fire for installation channels MT-40, MT-40 S, MT-40 OC and MT-40 S OC

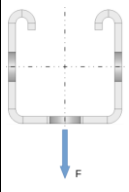
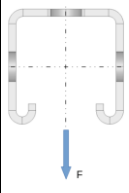
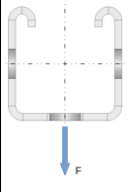
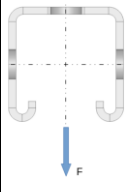
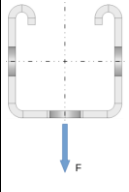
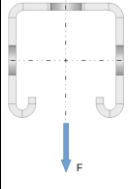
System			Load direction	σ_B	$V^{1)}$	$F^{2)}$	$\delta_{t_{max},B}$	$t_{max,B}$	δ_{30}	δ_{60}	δ_{90}	δ_{120}
Loadcase	L ³⁾	n		MPa	-	N	mm	min	mm	mm	mm	mm
1	1100	-		5	0,50	39,48	33,22	120,00	15,47	28,98	33,22	33,22
				10	0,50	88,07	74,41	120,00	26,88	57,05	72,87	74,41
				15	0,50	136,67	239,23	120,00	38,96	90,33	206,21	239,23
				20	0,50	185,27	258,30	120,00	56,43	119,83	226,92	258,30
				25	0,50	233,86	296,43	120,00	91,39	178,84	268,33	296,43
				30	0,50	282,46	366,34	120,00	155,48	287,01	344,25	366,34
1	1100	-		5	0,50	39,48	33,07	120,00	15,42	28,86	33,07	33,07
				10	0,50	88,07	71,67	120,00	26,83	56,81	71,67	71,67
				15	0,50	136,67	138,98	120,00	38,80	87,45	122,18	138,98
				20	0,50	185,27	195,23	100,00	53,90	119,16	175,19	-
				25	0,50	233,86	166,43	60,00	76,57	166,43	-	-
				30	0,50	282,46	161,66	33,33	117,67	-	-	-
2	1100	-		5	0,91	108,56	64,85	120,00	19,67	37,51	47,17	64,85
				10	0,91	242,20	167,07	120,00	53,82	128,22	159,56	167,07
				15	0,91	375,84	32,88	26,67	-	-	-	-
				20	0,91	509,48	14,53	20,00	-	-	-	-
				25	0,91	643,12	22,71	20,00	-	-	-	-
				30	0,91	776,76	10,70	13,33	-	-	-	-
2	1100	-		5	0,91	108,56	41,44	120,00	19,58	36,66	41,44	41,44
				10	0,91	242,20	106,27	120,00	36,53	80,03	102,35	106,27
				15	0,91	375,84	159,04	120,00	53,91	114,84	149,99	159,04
				20	0,91	509,48	196,32	120,00	77,09	141,68	183,62	196,32
				25	0,91	643,12	220,88	113,33	108,29	168,14	209,12	-
				30	0,91	776,76	210,10	73,33	139,59	191,47	-	-
3	1100	9		5	0,67	7,24	39,94	120,00	18,46	34,90	39,94	39,94
				10	0,67	16,15	123,54	120,00	33,46	77,16	109,11	123,54
				15	0,67	25,06	125,50	60,00	51,36	125,50	-	-
				20	0,67	33,97	43,79	26,67	-	-	-	-
				25	0,67	42,87	94,23	26,67	-	-	-	-
				30	0,67	51,78	26,93	20,00	-	-	-	-
3	1100	9		5	0,67	7,24	38,53	120,00	18,06	33,93	38,53	38,53
				10	0,67	16,15	101,85	120,00	32,63	72,86	96,01	101,85
				15	0,67	25,06	200,65	120,00	48,45	111,77	165,05	200,65
				20	0,67	33,97	203,56	73,33	71,61	162,12	-	-
				25	0,67	42,87	157,79	33,33	112,57	-	-	-
				30	0,67	51,78	120,18	26,67	-	-	-	-

¹⁾ Momentum degree of fullness without contribution from channel dead weight

²⁾ Size of designated system's single load

³⁾ Dimensions in mm and inch

Symbols and designation see Annex D1

Hilti MT installation channels

Bending characteristics of the channel in case of fire

Annex D11

Table D30: Calculation-based deformation in case of fire for installation channels MT-40, MT-40 S, MT-40 OC and MT-40 S OC

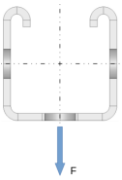
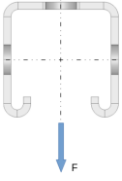
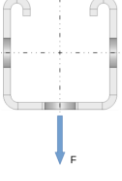
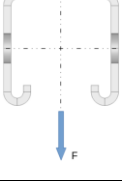
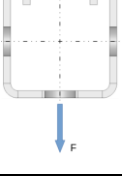
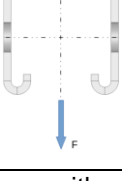
System			Load direction	σ_B	$V^{1)}$	$F^{2)}$	$\delta_{t_{max},B}$	$t_{max,B}$	δ_{30}	δ_{60}	δ_{90}	δ_{120}
Loadcase	$L^3)$	n		MPa	-	N	mm	min	mm	mm	mm	mm
1	1300	-		5	0,50	30,34	43,60	120,00	20,70	38,71	43,60	43,60
				10	0,50	71,46	112,78	120,00	36,48	77,59	99,91	112,78
				15	0,50	112,58	302,96	120,00	53,02	131,77	265,87	302,96
				20	0,50	153,70	327,10	120,00	77,44	175,90	292,86	327,10
				25	0,50	194,82	375,39	120,00	126,29	264,16	346,84	375,39
				30	0,50	235,94	463,92	120,00	215,85	400,97	445,81	463,92
1	1300	-		5	0,50	30,34	43,32	120,00	20,57	38,47	43,32	43,32
				10	0,50	71,46	99,22	120,00	36,36	77,03	96,56	99,22
				15	0,50	112,58	182,83	120,00	52,73	117,41	160,72	182,83
				20	0,50	153,70	248,19	100,00	72,97	156,41	223,40	-
				25	0,50	194,82	211,25	60,00	101,99	211,25	-	-
				30	0,50	235,94	200,01	33,33	150,01	-	-	-
2	1300	-		5	0,92	98,62	97,40	120,00	26,24	63,24	93,40	97,40
				10	0,92	232,26	193,18	120,00	70,38	154,26	185,57	193,18
				15	0,92	365,90	239,93	120,00	125,32	194,98	229,14	239,93
				20	0,92	499,54	269,84	120,00	165,60	223,13	257,30	269,84
				25	0,92	633,18	294,54	120,00	196,07	248,44	281,67	294,54
				30	0,92	766,82	308,59	120,00	217,20	265,80	296,93	308,59
2	1300	-		5	0,92	98,62	53,87	120,00	25,84	48,28	53,87	53,87
				10	0,92	232,26	136,51	120,00	48,96	104,44	130,41	136,51
				15	0,92	365,90	196,00	120,00	71,65	146,83	184,74	196,00
				20	0,92	499,54	235,22	120,00	100,18	177,06	221,83	235,22
				25	0,92	633,18	269,50	120,00	137,08	203,09	249,35	269,50
				30	0,92	766,82	280,35	100,00	170,89	228,08	270,77	-
3	1300	11		5	0,67	4,70	53,87	120,00	25,06	47,65	53,87	53,87
				10	0,67	11,06	201,67	120,00	45,88	105,13	145,10	201,67
				15	0,67	17,42	216,61	73,33	70,01	173,48	-	-
				20	0,67	23,79	162,54	33,33	111,09	-	-	-
				25	0,67	30,15	121,52	26,67	-	-	-	-
				30	0,67	36,52	36,81	20,00	-	-	-	-
3	1300	11		5	0,67	4,70	51,15	120,00	24,28	45,69	51,15	51,15
				10	0,67	11,06	141,25	120,00	44,48	99,51	130,22	141,25
				15	0,67	17,42	256,59	120,00	66,26	151,14	217,05	256,59
				20	0,67	23,79	279,82	80,00	97,46	211,49	-	-
				25	0,67	30,15	239,46	40,00	147,96	-	-	-
				30	0,67	36,52	159,28	26,67	-	-	-	-

¹⁾ Momentum degree of fullness without contribution from channel dead weight

²⁾ Size of designated system's single load

³⁾ Dimensions in mm and inch

Symbols and designation see Annex D1

Hilti MT installation channels

Bending characteristics of the channel in case of fire

Annex D12

Table D31: Calculation-based deformation in case of fire for installation channels MT-40, MT-40 S, MT-40 OC and MT-40 S OC

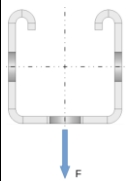
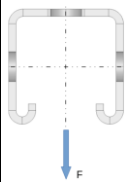
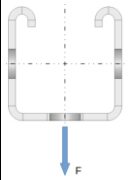
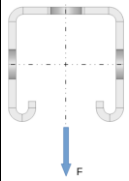
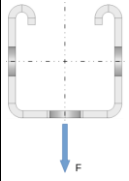
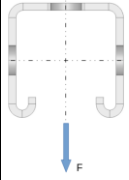
System			Load direction	σ_B	$V^{1)}$	$F^{2)}$	$\delta_{t_{max},B}$	$t_{max,B}$	δ_{30}	δ_{60}	δ_{90}	δ_{120}
Loadcase	$L^{3)}$	n		MPa	-	N	mm	min	mm	mm	mm	mm
1	1500	-		5	0,50	23,20	56,41	120,00	27,14	50,70	56,41	56,41
				10	0,50	58,84	214,05	120,00	47,91	101,60	140,22	214,05
				15	0,50	94,48	346,77	120,00	69,39	223,90	310,06	346,77
				20	0,50	130,12	374,41	120,00	101,89	292,56	341,71	374,41
				25	0,50	165,75	429,68	120,00	166,90	344,86	405,02	429,68
				30	0,50	201,39	531,02	120,00	286,09	480,93	518,58	531,02
1	1500	-		5	0,50	23,20	56,01	120,00	26,96	50,37	56,01	56,01
				10	0,50	58,84	131,92	120,00	47,75	100,84	125,60	131,92
				15	0,50	94,48	229,81	120,00	69,03	151,09	202,67	229,81
				20	0,50	130,12	303,49	100,00	94,76	196,85	274,61	-
				25	0,50	165,75	258,09	60,00	130,26	258,09	-	-
				30	0,50	201,39	241,27	33,33	185,29	-	-	-
2	1500	-		5	0,93	87,01	120,23	120,00	35,67	94,50	118,16	120,23
				10	0,93	220,65	223,72	120,00	86,15	180,58	214,32	223,72
				15	0,93	354,29	271,31	120,00	147,41	224,17	260,30	271,31
				20	0,93	487,93	304,59	120,00	191,90	257,55	293,32	304,59
				25	0,93	621,57	326,22	120,00	222,90	281,83	315,54	326,22
				30	0,93	755,21	341,37	120,00	245,92	300,21	331,67	341,37
2	1500	-		5	0,93	87,01	68,17	120,00	33,08	61,62	68,17	68,17
				10	0,93	220,65	168,22	120,00	62,97	130,45	159,92	168,22
				15	0,93	354,29	234,63	120,00	91,22	179,77	220,70	234,63
				20	0,93	487,93	276,44	120,00	125,02	214,06	261,22	276,44
				25	0,93	621,57	308,63	120,00	166,96	241,07	291,16	308,63
				30	0,93	755,21	331,56	106,67	203,66	268,45	315,30	-
3	1500	13		5	0,67	3,11	71,56	120,00	33,30	63,70	71,56	71,56
				10	0,67	7,88	231,73	120,00	60,74	137,88	186,56	231,73
				15	0,67	12,65	318,10	80,00	91,82	212,84	-	-
				20	0,67	17,43	206,39	33,33	142,75	-	-	-
				25	0,67	22,20	152,49	26,67	-	-	-	-
				30	0,67	26,97	48,56	20,00	-	-	-	-
3	1500	13		5	0,67	3,11	66,83	120,00	31,90	60,22	66,83	66,83
				10	0,67	7,88	186,48	120,00	58,63	130,92	170,04	186,48
				15	0,67	12,65	315,67	120,00	87,19	195,73	273,24	315,67
				20	0,67	17,43	382,97	93,33	127,09	264,33	369,84	-
				25	0,67	22,20	345,70	53,33	187,00	-	-	-
				30	0,67	26,97	201,57	26,67	-	-	-	-

¹⁾ Momentum degree of fullness without contribution from channel dead weight

²⁾ Size of designated system's single load

³⁾ Dimensions in mm and inch

Symbols and designation see Annex D1

Hilti MT installation channels

Bending characteristics of the channel in case of fire

Annex D13

Table D32: Calculation-based deformation in case of fire for installation channels MT-40D, MT-40D S, MT-40D OC and MT-40D S OC

System			Load direction	σ_B	$V^{1)}$	$F^{2)}$	$\delta_{t_{max},B}$	$t_{max,B}$	δ_{30}	δ_{60}	δ_{90}	δ_{120}
Loadcase	L ³⁾	n ⁴⁾		MPa	-	N	mm	min	mm	mm	mm	mm
1	600	-		5	0,50	225,04	29,03	120,00	20,77	21,10	27,93	29,03
				10	0,50	459,99	34,30	106,67	22,57	24,76	32,96	-
				15	0,50	694,95	29,63	46,67	24,85	-	-	-
				20	0,50	929,90	24,07	26,67	-	-	-	-
				25	0,50	1164,86	16,09	20,00	-	-	-	-
				30	0,50	1399,81	16,76	20,00	-	-	-	-
1	600	-		5	0,50	225,04	29,76	120,00	21,01	21,55	28,54	29,76
				10	0,50	459,99	37,13	120,00	23,13	25,86	34,48	37,13
				15	0,50	694,95	51,07	93,33	25,89	32,55	48,92	-
				20	0,50	929,90	45,48	53,33	29,67	-	-	-
				25	0,50	1164,86	51,18	33,33	40,07	-	-	-
				30	0,50	1399,81	38,07	26,67	-	-	-	-
2	600	-		5	0,88	450,07	31,95	120,00	21,70	22,84	30,27	31,95
				10	0,88	919,98	49,52	100,00	25,55	32,51	45,49	-
				15	0,88	1389,89	41,81	40,00	31,78	-	-	-
				20	0,88	1859,80	33,88	26,67	-	-	-	-
				25	0,88	2329,71	19,03	20,00	-	-	-	-
				30	0,88	2799,62	11,26	13,33	-	-	-	-
2	600	-		5	0,88	450,07	31,23	120,00	21,54	22,50	29,74	31,23
				10	0,88	919,98	70,61	120,00	24,83	30,22	42,27	70,61
				15	0,88	1389,89	109,11	73,33	29,76	71,64	-	-
				20	0,88	1859,80	102,70	33,33	66,52	-	-	-
				25	0,88	2329,71	18,22	20,00	-	-	-	-
				30	0,88	2799,62	20,29	20,00	-	-	-	-
3	600	6		5	0,67	56,26	29,88	120,00	21,08	21,63	28,62	29,88
				10	0,67	115,00	39,10	120,00	23,46	26,83	36,01	39,10
				15	0,67	173,74	59,36	93,33	26,60	35,39	55,68	-
				20	0,67	232,48	53,74	53,33	31,27	-	-	-
				25	0,67	291,21	54,25	33,33	42,38	-	-	-
				30	0,67	349,95	42,81	26,67	-	-	-	-
3	600	6		5	0,67	56,26	30,13	120,00	21,18	21,80	28,83	30,13
				10	0,67	115,00	39,64	120,00	23,67	27,13	36,30	39,64
				15	0,67	173,74	88,93	73,33	26,88	37,36	-	-
				20	0,67	232,48	39,56	33,33	32,91	-	-	-
				25	0,67	291,21	31,49	26,67	-	-	-	-
				30	0,67	349,95	17,92	20,00	-	-	-	-

¹⁾ Momentum degree of fullness without contribution from channel dead weight

²⁾ Size of designated system's single load

³⁾ Dimensions in mm and inch

⁴⁾ distance between loads is 75 mm

Symbols and designation see Annex D1

Hilti MT installation channels

Bending characteristics of the channel in case of fire

Annex D14

Table D33: Calculation-based deformation in case of fire for installation channels MT-40D, MT-40D S, MT-40D OC and MT-40D S OC

System			Load direction	σ_B	$V^{1)}$	$F^{2)}$	$\delta_{t_{max},B}$	$t_{max,B}$	δ_{30}	δ_{60}	δ_{90}	δ_{120}
Loadcase	$L^{3)}$	$n^{4)}$		MPa	-	N	mm	min	mm	mm	mm	mm
1	900	-		5	0,50	141,76	32,60	120,00	22,02	23,26	30,77	32,60
				10	0,50	298,40	45,36	120,00	25,68	30,86	41,26	45,36
				15	0,50	455,03	61,61	93,33	30,33	42,56	60,15	-
				20	0,50	611,67	60,56	60,00	36,58	60,56	-	-
				25	0,50	768,31	57,06	33,33	46,26	-	-	-
				30	0,50	924,94	45,50	26,67	-	-	-	-
1	900	-		5	0,50	141,76	33,02	120,00	22,16	23,52	31,12	33,02
				10	0,50	298,40	46,90	120,00	26,03	31,56	42,27	46,90
				15	0,50	455,03	83,81	73,33	30,99	44,65	-	-
				20	0,50	611,67	99,25	40,00	38,05	-	-	-
				25	0,50	768,31	37,11	26,67	-	-	-	-
				30	0,50	924,94	20,15	20,00	-	-	-	-
2	900	-		5	0,92	425,28	37,28	120,00	23,63	26,18	34,56	37,28
				10	0,92	895,19	216,07	120,00	30,87	44,28	172,94	216,07
				15	0,92	1365,10	352,83	120,00	42,55	224,71	322,16	352,83
				20	0,92	1835,01	48,14	26,67	-	-	-	-
				25	0,92	2304,92	22,94	20,00	-	-	-	-
				30	0,92	2774,83	12,84	13,33	-	-	-	-
2	900	-		5	0,92	425,28	36,50	120,00	23,46	25,81	33,99	36,50
				10	0,92	895,19	171,23	120,00	30,02	41,24	57,99	171,23
				15	0,92	1365,10	269,20	120,00	39,22	124,11	227,73	269,20
				20	0,92	1835,01	324,85	93,33	88,86	269,31	321,21	-
				25	0,92	2304,92	22,07	20,00	-	-	-	-
				30	0,92	2774,83	25,60	20,00	-	-	-	-
3	900	10		5	0,67	23,63	34,39	120,00	22,69	24,42	32,23	34,39
				10	0,67	49,73	53,46	120,00	27,56	35,26	47,63	53,46
				15	0,67	75,84	99,13	106,67	33,89	52,19	78,29	-
				20	0,67	101,94	105,46	66,67	43,24	83,43	-	-
				25	0,67	128,05	78,01	33,33	60,60	-	-	-
				30	0,67	154,16	63,45	26,67	0,00	-	-	-
3	900	10		5	0,67	23,63	34,40	120,00	22,70	24,44	32,25	34,40
				10	0,67	49,73	54,30	120,00	27,61	35,20	47,41	54,30
				15	0,67	75,84	302,03	120,00	33,89	56,23	241,46	302,03
				20	0,67	101,94	354,07	120,00	46,82	249,66	322,40	354,07
				25	0,67	128,05	46,17	26,67	-	-	-	-
				30	0,67	154,16	21,64	20,00	-	-	-	-

1) Momentum degree of fullness without contribution from channel dead weight

2) Size of designated system's single load

3) Dimensions in mm and inch

4) distance between loads is 75 mm

Symbols and designation see Annex D1

Hilti MT installation channels

Bending characteristics of the channel in case of fire

Annex D15

Table D34: Calculation-based deformation in case of fire for installation channels MT-40D, MT-40D S, MT-40D OC and MT-40D S OC

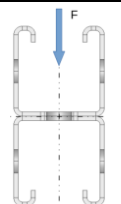
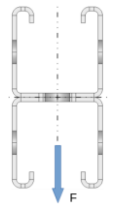
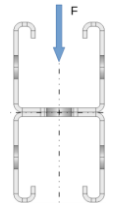
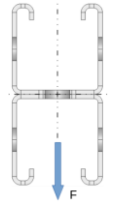
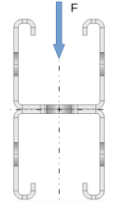
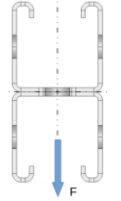
System			Load direction	σ_B	$V^{1)}$	$F^{2)}$	$\delta_{t_{max},B}$	$t_{max,B}$	δ_{30}	δ_{60}	δ_{90}	δ_{120}
Loadcase	$L^{3)}$	$n^{4)}$		MPa	-	N	mm	min	mm	mm	mm	mm
1	1200	-		5	0,50	97,64	38,03	120,00	23,92	26,56	35,10	38,03
				10	0,50	215,12	60,76	120,00	30,31	40,02	53,76	60,76
				15	0,50	332,60	100,54	93,33	38,43	60,69	94,64	-
				20	0,50	450,07	96,88	60,00	49,42	96,88	-	-
				25	0,50	567,55	98,24	33,33	73,19	-	-	-
				30	0,50	685,03	67,35	26,67	-	-	-	-
1	1200	-		5	0,50	97,64	38,33	120,00	24,03	26,75	35,35	38,33
				10	0,50	215,12	63,62	120,00	30,58	40,57	54,82	63,62
				15	0,50	332,60	124,16	66,67	38,98	77,89	-	-
				20	0,50	450,07	82,47	33,33	60,51	-	-	-
				25	0,50	567,55	50,68	26,67	-	-	-	-
				30	0,50	685,03	24,23	20,00	-	-	-	-
2	1200	-		5	0,94	390,57	44,88	120,00	26,35	30,91	40,66	44,88
				10	0,94	860,48	297,70	120,00	38,46	62,61	236,26	297,70
				15	0,94	1330,39	451,21	120,00	89,14	266,52	361,85	451,21
				20	0,94	450,07	82,47	33,33	60,51	-	-	-
				25	0,94	567,55	50,68	26,67	-	-	-	-
				30	0,94	685,03	24,23	20,00	-	-	-	-
2	1200	-		5	0,94	390,57	44,06	120,00	26,17	30,51	40,07	44,06
				10	0,94	860,48	245,42	120,00	37,38	57,47	128,19	245,42
				15	0,94	1330,39	337,90	120,00	56,50	215,81	296,46	337,90
				20	0,94	1800,30	356,63	93,33	148,97	303,55	351,38	-
				25	0,94	2270,21	27,52	20,00	-	-	-	-
				30	0,94	2740,12	33,24	20,00	-	-	-	-
3	1200	14		5	0,67	12,21	41,25	120,00	25,15	28,69	37,76	41,25
				10	0,67	26,89	74,91	120,00	33,66	47,82	64,97	74,91
				15	0,67	41,57	215,97	120,00	44,62	76,85	119,32	215,97
				20	0,67	56,26	404,68	120,00	60,71	135,49	330,01	404,68
				25	0,67	70,94	417,72	120,00	92,26	299,78	378,43	417,72
				30	0,67	85,63	435,77	120,00	183,39	334,63	396,70	435,77
3	1200	14		5	0,67	12,21	41,05	120,00	25,08	28,57	37,59	41,05
				10	0,67	26,89	77,11	120,00	33,59	47,51	64,45	77,11
				15	0,67	41,57	320,15	120,00	44,48	79,83	267,60	320,15
				20	0,67	56,26	406,31	120,00	68,73	274,25	360,25	406,31
				25	0,67	70,94	471,09	120,00	168,76	357,24	431,36	471,09
				30	0,67	85,63	27,26	20,00	-	-	-	-

1) Momentum degree of fullness without contribution from channel dead weight

2) Size of designated system's single load

3) Dimensions in mm and inch

4) distance between loads is 75 mm

Symbols and designation see Annex D1

Hilti MT installation channels

Bending characteristics of the channel in case of fire

Annex D16

Table D35: Calculation-based deformation in case of fire for installation channels MT-40D, MT-40D S, MT-40D OC and MT-40D S OC

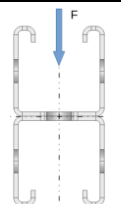
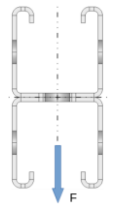
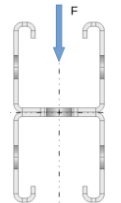
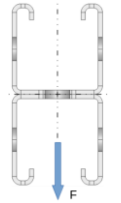
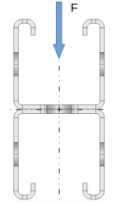
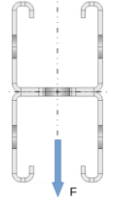
System			Load direction	σ_B	$V^{1)}$	$F^{2)}$	$\delta_{t_{max},B}$	$t_{max,B}$	δ_{30}	δ_{60}	δ_{90}	δ_{120}
Loadcase	$L^{3)}$	$n^{4)}$		MPa	-	N	mm	min	mm	mm	mm	mm
1	1500	-		5	0,50	69,19	45,74	120,00	26,63	31,26	41,26	45,74
				10	0,50	163,17	82,38	120,00	36,66	52,69	71,13	82,38
				15	0,50	257,15	535,47	120,00	49,36	85,67	365,37	535,47
				20	0,50	351,13	614,33	120,00	66,93	397,13	559,35	614,33
				25	0,50	445,12	65,42	26,67	-	-	-	-
				30	0,50	539,10	100,62	26,67	-	-	-	-
1	1500	-		5	0,50	69,19	45,96	120,00	26,71	31,40	41,44	45,96
				10	0,50	163,17	142,87	120,00	36,88	53,38	74,25	142,87
				15	0,50	257,15	158,32	60,00	50,17	158,32	-	-
				20	0,50	351,13	50,18	26,67	-	-	-	-
				25	0,50	445,12	82,42	26,67	-	-	-	-
				30	0,50	539,10	29,74	20,00	-	-	-	-
2	1500	-		5	0,95	345,94	54,93	120,00	29,88	37,06	48,72	54,93
				10	0,95	815,85	369,45	120,00	48,57	131,06	308,28	369,45
				15	0,95	1285,76	459,22	120,00	138,22	337,06	414,37	459,22
				20	0,95	1755,67	28,80	20,00	-	-	-	-
				25	0,95	2225,58	35,81	20,00	-	-	-	-
				30	0,95	2695,49	47,51	20,00	-	-	-	-
2	1500	-		5	0,95	345,94	53,90	120,00	29,66	36,58	47,98	53,90
				10	0,95	815,85	306,27	120,00	46,97	92,37	228,43	306,27
				15	0,95	1285,76	399,57	120,00	96,73	281,78	358,66	399,57
				20	0,95	1755,67	419,41	93,33	218,19	356,20	415,04	-
				25	0,95	2225,58	34,54	20,00	-	-	-	-
				30	0,95	2695,49	43,76	20,00	-	-	-	-
3	1500	18		5	0,67	6,92	50,87	120,00	28,62	34,72	45,53	50,87
				10	0,67	16,32	103,91	120,00	41,90	64,82	88,37	103,91
				15	0,67	25,72	260,97	120,00	58,88	109,10	172,36	260,97
				20	0,67	35,11	446,80	120,00	83,63	185,15	363,88	446,80
				25	0,67	44,51	492,69	120,00	127,97	320,20	439,26	492,69
				30	0,67	53,91	524,41	120,00	212,58	389,87	476,04	524,41
3	1500	18		5	0,67	6,92	50,28	120,00	28,40	34,33	45,04	50,28
				10	0,67	16,32	105,82	120,00	41,66	64,16	87,48	105,82
				15	0,67	25,72	373,86	120,00	58,58	120,45	302,62	373,86
				20	0,67	35,11	454,01	120,00	93,96	310,78	404,32	454,01
				25	0,67	44,51	506,10	120,00	204,98	392,10	464,26	506,10
				30	0,67	53,91	34,71	20,00	-	-	-	-

1) Momentum degree of fullness without contribution from channel dead weight

2) Size of designated system's single load

3) Dimensions in mm and inch

4) distance between loads is 75 mm

Symbols and designation see Annex D1

Hilti MT installation channels

Bending characteristics of the channel in case of fire

Annex D17

Table D36: Calculation-based deformation in case of fire for installation channels MT-40D, MT-40D S, MT-40D OC and MT-40D S OC

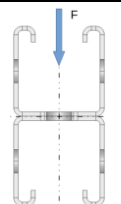
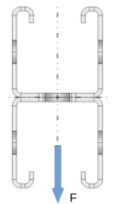
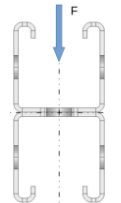
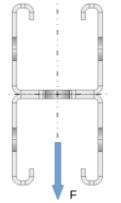
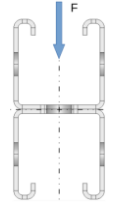
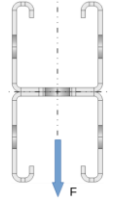
System			Load direction	σ_B MPa	$V^{1)}$ -	$F^{2)}$ N	$\delta_{t_{max},B}$ mm	$t_{max,B}$ min	δ_{30} mm	δ_{60} mm	δ_{90} mm	δ_{120} mm
Loadcase	$L^{3)}$	$n^{4)}$										
1	1800	-		5	0,50	48,56	56,23	120,00	30,35	37,73	49,67	56,23
				10	0,50	126,88	112,31	120,00	44,97	69,47	94,33	112,31
				15	0,50	205,20	643,50	120,00	63,43	120,15	465,60	643,50
				20	0,50	283,52	736,31	120,00	90,50	481,96	671,69	736,31
				25	0,50	361,84	88,15	26,67	-	-	-	-
				30	0,50	440,16	36,39	20,00	-	-	-	-
1	1800	-		5	0,50	48,56	56,56	120,00	30,40	37,84	49,89	56,56
				10	0,50	126,88	215,20	113,33	45,24	71,56	114,86	0,00
				15	0,50	205,20	255,72	60,00	66,42	255,72	-	-
				20	0,50	283,52	66,43	26,67	-	-	-	-
				25	0,50	361,84	31,28	20,00	-	-	-	-
				30	0,50	440,16	36,80	20,00	-	-	-	-
2	1800	-		5	0,96	291,39	68,72	120,00	34,23	44,74	59,13	68,72
				10	0,96	761,30	453,17	120,00	64,04	215,19	383,81	453,17
				15	0,96	1231,21	555,84	120,00	187,63	414,88	503,93	555,84
				20	0,96	1701,12	35,05	20,00	-	-	-	-
				25	0,96	2171,03	45,16	20,00	-	-	-	-
				30	0,96	2640,94	84,77	20,00	-	-	-	-
2	1800	-		5	0,96	291,39	67,40	120,00	33,98	44,17	58,23	67,40
				10	0,96	761,30	382,16	120,00	60,71	155,72	306,30	382,16
				15	0,96	1231,21	485,94	120,00	137,04	348,57	437,59	485,94
				20	0,96	1701,12	531,10	106,67	283,26	434,52	503,20	-
				25	0,96	2171,03	43,39	20,00	-	-	-	-
				30	0,96	2640,94	63,40	20,00	-	-	-	-
3	1800	22		5	0,67	4,05	63,87	120,00	33,35	42,93	56,10	63,87
				10	0,67	10,57	141,47	120,00	52,50	86,66	118,34	141,47
				15	0,67	17,10	297,70	120,00	76,83	148,75	222,35	297,70
				20	0,67	23,63	484,26	120,00	112,32	231,99	367,82	484,26
				25	0,67	30,15	555,64	120,00	165,54	324,29	477,35	555,64
				30	0,67	36,68	621,82	120,00	264,33	485,90	571,73	621,82
3	1800	22		5	0,67	4,05	62,58	120,00	32,85	42,06	55,01	62,58
				10	0,67	10,57	152,86	120,00	51,97	85,49	116,95	152,86
				15	0,67	17,10	515,00	120,00	76,35	283,85	442,53	515,00
				20	0,67	23,63	533,27	120,00	129,86	365,09	474,43	533,27
				25	0,67	30,15	594,47	120,00	268,94	459,35	544,96	594,47
				30	0,67	36,68	44,07	20,00	-	-	-	-

1) Momentum degree of fullness without contribution from channel dead weight

2) Size of designated system's single load

3) Dimensions in mm and inch

4) distance between loads is 75 mm

Symbols and designation see Annex D1

Hilti MT installation channels

Bending characteristics of the channel in case of fire

Annex D18

Table D37: Calculation-based deformation in case of fire for installation channels MT-40D, MT-40D S, MT-40D OC and MT-40D S OC

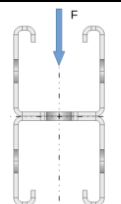
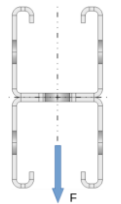
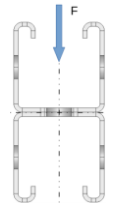
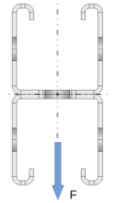
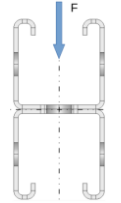
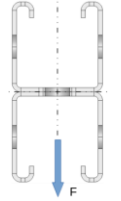
System			Load direction	σ_B	$V^{1)}$	$F^{2)}$	$\delta_{tmax,B}$	$t_{max,B}$	δ_{30}	δ_{60}	δ_{90}	δ_{120}
Loadcase	L ³⁾	n ⁴⁾		MPa	-	N	mm	min	mm	mm	mm	mm
1	2100	-		5	0,50	32,42	70,26	120,00	35,34	46,42	60,99	70,26
				10	0,50	99,55	160,00	120,00	55,57	91,18	125,20	160,00
				15	0,50	166,68	754,89	120,00	81,09	179,27	586,20	754,89
				20	0,50	233,81	844,22	120,00	126,46	578,16	775,90	844,22
				25	0,50	300,94	914,22	120,00	345,59	761,26	866,24	914,22
				30	0,50	368,07	44,97	20,00	-	-	-	-
1	2100	-		5	0,50	32,42	71,58	120,00	35,38	46,62	61,65	71,58
				10	0,50	99,55	306,50	106,67	56,18	99,29	193,76	0,00
				15	0,50	166,68	320,74	53,33	92,19	-	-	-
				20	0,50	233,81	91,87	26,67	-	-	-	-
				25	0,50	300,94	37,93	20,00	-	-	-	-
				30	0,50	368,07	45,68	20,00	-	-	-	-
2	2100	-		5	0,96	226,92	95,31	120,00	39,45	54,31	73,91	95,31
				10	0,96	696,83	534,70	120,00	92,83	283,75	456,00	534,70
				15	0,96	1166,74	655,13	120,00	240,96	490,69	594,40	655,13
				20	0,96	1636,65	42,70	20,00	-	-	-	-
				25	0,96	2106,56	59,09	20,00	-	-	-	-
				30	0,96	2576,47	157,74	20,00	-	-	-	-
2	2100	-		5	0,96	226,92	92,91	120,00	39,20	53,76	73,15	92,91
				10	0,96	696,83	460,35	120,00	84,99	218,41	378,63	460,35
				15	0,96	1166,74	575,80	120,00	184,46	415,51	519,45	575,80
				20	0,96	1636,65	638,73	113,33	340,41	515,23	595,97	-
				25	0,96	2106,56	55,93	20,00	-	-	-	-
				30	0,96	2576,47	107,34	20,00	-	-	-	-
3	2100	26		5	0,67	2,32	81,18	120,00	39,61	53,87	70,32	81,18
				10	0,67	7,11	186,73	120,00	65,82	113,93	155,64	186,73
				15	0,67	11,91	341,37	120,00	98,81	193,17	272,87	341,37
				20	0,67	16,70	509,61	120,00	145,00	279,39	390,52	509,61
				25	0,67	21,50	650,97	120,00	206,30	363,26	582,77	650,97
				30	0,67	26,29	693,53	120,00	278,93	515,32	632,55	693,53
3	2100	26		5	0,67	2,32	78,70	120,00	38,65	52,19	68,17	78,70
				10	0,67	7,11	220,87	120,00	64,84	112,07	153,58	220,87
				15	0,67	11,91	581,64	120,00	98,03	308,03	499,02	581,64
				20	0,67	16,70	608,72	120,00	166,38	416,71	540,47	608,72
				25	0,67	21,50	679,83	120,00	319,85	522,61	622,08	679,83
				30	0,67	26,29	55,43	20,00	-	-	-	-

1) Momentum degree of fullness without contribution from channel dead weight

2) Size of designated system's single load

3) Dimensions in mm and inch

4) distance between loads is 75 mm

Symbols and designation see Annex D1

Hilti MT installation channels

Bending characteristics of the channel in case of fire

Annex D19

Table D38: Calculation-based deformation in case of fire for installation channels MT-50, MT-50 S, MT-50 OC and MT-50 S OC

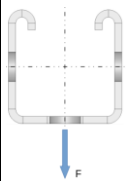
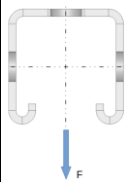
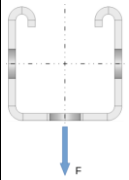
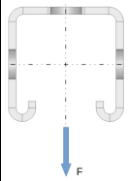
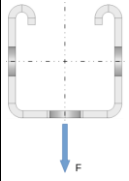
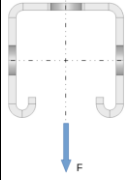
System			Load direction	σ_B	$V^{1)}$	$F^{2)}$	$\delta_{t_{max},B}$	$t_{max,B}$	δ_{30}	δ_{60}	δ_{90}	δ_{120}
Loadcase	$L^3)$	n		MPa	-	N	mm	min	mm	mm	mm	mm
1	500	-		5	0,50	122,79	9,93	120,00	7,50	7,50	9,93	9,93
				10	0,50	250,89	17,22	120,00	10,28	13,00	17,22	17,22
				15	0,50	379,00	36,62	120,00	13,10	19,74	28,87	36,62
				20	0,50	507,11	121,28	120,00	15,97	27,73	75,78	121,28
				25	0,50	635,22	140,57	120,00	18,95	39,35	115,74	140,57
				30	0,50	763,33	160,60	120,00	22,61	89,52	141,98	160,60
1	500	-		5	0,50	122,79	10,02	120,00	7,54	7,55	10,02	10,02
				10	0,50	250,89	17,36	120,00	10,36	13,16	17,36	17,36
				15	0,50	379,00	31,72	120,00	13,21	19,80	27,84	31,72
				20	0,50	507,11	59,92	106,67	16,08	27,08	45,86	-
				25	0,50	635,22	48,63	73,33	19,04	35,76	-	-
				30	0,50	763,33	49,46	60,00	22,31	49,46	-	-
2	500	-		5	0,80	153,48	12,25	120,00	8,53	9,34	12,25	12,25
				10	0,80	313,62	29,54	106,67	12,39	17,67	24,46	-
				15	0,80	473,75	24,19	53,33	16,29	-	-	-
				20	0,80	633,89	15,74	26,67	-	-	-	-
				25	0,80	794,02	6,73	20,00	-	-	-	-
				30	0,80	954,16	7,64	20,00	-	-	-	-
2	500	-		5	0,80	153,48	12,40	120,00	8,58	9,46	12,40	12,40
				10	0,80	313,62	24,65	120,00	12,53	17,95	23,70	24,65
				15	0,80	473,75	54,72	120,00	16,53	27,87	43,02	54,72
				20	0,80	633,89	57,89	80,00	20,56	38,74	-	-
				25	0,80	794,02	52,52	60,00	24,82	52,52	-	-
				30	0,80	954,16	51,68	46,67	30,86	-	-	-
3	500	3		5	0,67	51,16	11,35	120,00	8,12	8,60	11,35	11,35
				10	0,67	104,54	20,99	120,00	11,55	15,76	20,89	20,99
				15	0,67	157,92	38,93	93,33	15,05	24,35	37,73	-
				20	0,67	211,30	39,18	66,67	18,59	34,19	-	-
				25	0,67	264,67	33,21	46,67	22,26	-	-	-
				30	0,67	318,05	34,27	33,33	27,21	-	-	-
3	500	3		5	0,67	51,16	11,46	120,00	8,17	8,70	11,46	11,46
				10	0,67	104,54	21,15	120,00	11,66	15,98	21,11	21,15
				15	0,67	157,92	46,92	120,00	15,19	24,60	36,86	46,92
				20	0,67	211,30	68,02	93,33	18,76	34,11	64,24	-
				25	0,67	264,67	55,44	66,67	22,46	46,32	-	-
				30	0,67	318,05	57,75	53,33	27,30	-	-	-

¹⁾ Momentum degree of fullness without contribution from channel dead weight

²⁾ Size of designated system's single load

³⁾ Dimensions in mm and inch

Symbols and designation see Annex D1

Hilti MT installation channels

Bending characteristics of the channel in case of fire

Annex D20

Table D39: Calculation-based deformation in case of fire for installation channels MT-50, MT-50 S, MT-50 OC and MT-50 S OC

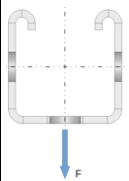
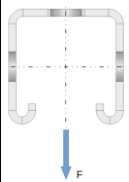
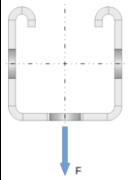
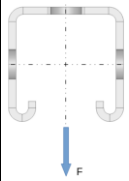
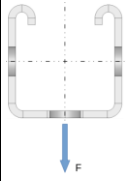
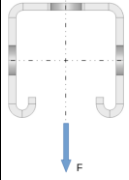
System			Load direction	σ_B	$V^{1)}$	$F^{2)}$	$\delta_{t_{max},B}$	$t_{max,B}$	δ_{30}	δ_{60}	δ_{90}	δ_{120}
Loadcase	$L^{3)}$	n		MPa	-	N	mm	min	mm	mm	mm	mm
1	700	-		5	0,50	84,06	15,96	120,00	10,15	12,34	15,96	15,96
				10	0,50	175,56	31,24	120,00	15,46	23,06	30,07	31,24
				15	0,50	267,07	110,67	120,00	20,88	35,87	52,26	110,67
				20	0,50	358,57	171,86	120,00	26,37	50,61	141,00	171,86
				25	0,50	450,08	203,36	120,00	32,00	114,31	178,10	203,36
				30	0,50	541,58	229,95	120,00	38,73	153,52	207,78	229,95
1	700	-		5	0,50	84,06	16,00	120,00	10,18	12,38	16,00	16,00
				10	0,50	175,56	30,84	120,00	15,51	23,02	29,88	30,84
				15	0,50	267,07	59,05	120,00	20,90	35,50	49,33	59,05
				20	0,50	358,57	95,65	106,67	26,31	48,86	79,15	-
				25	0,50	450,08	99,89	80,00	31,79	63,88	-	-
				30	0,50	541,58	96,53	60,00	40,22	96,53	-	-
2	700	-		5	0,86	147,10	20,84	120,00	12,31	16,28	20,84	20,84
				10	0,86	307,23	115,84	120,00	20,01	34,24	97,06	115,84
				15	0,86	467,37	105,04	60,00	27,88	105,04	-	-
				20	0,86	627,50	26,84	26,67	-	-	-	-
				25	0,86	787,64	9,97	20,00	-	-	-	-
				30	0,86	947,77	11,79	20,00	-	-	-	-
2	700	-		5	0,86	147,10	20,93	120,00	12,34	16,36	20,93	20,93
				10	0,86	307,23	47,57	120,00	20,12	32,93	42,72	47,57
				15	0,86	467,37	86,89	120,00	27,91	51,31	73,61	86,89
				20	0,86	627,50	120,84	113,33	35,66	69,31	105,06	-
				25	0,86	787,64	117,95	80,00	43,53	87,39	-	-
				30	0,86	947,77	119,64	66,67	53,39	106,26	-	-
3	700	5		5	0,67	24,52	18,74	120,00	11,38	14,57	18,74	18,74
				10	0,67	51,21	40,15	120,00	17,97	28,24	36,84	40,15
				15	0,67	77,89	68,81	93,33	24,62	44,09	66,48	-
				20	0,67	104,58	69,64	66,67	31,30	61,24	-	-
				25	0,67	131,27	58,57	46,67	38,14	-	-	-
				30	0,67	157,96	59,47	33,33	46,96	-	-	-
3	700	5		5	0,67	24,52	18,81	120,00	11,41	14,65	18,81	18,81
				10	0,67	51,21	40,15	120,00	18,06	28,46	36,99	40,15
				15	0,67	77,89	78,46	120,00	24,76	44,37	63,93	78,46
				20	0,67	104,58	131,24	120,00	31,46	60,84	98,26	131,24
				25	0,67	131,27	131,04	86,67	38,27	78,89	-	-
				30	0,67	157,96	119,58	66,67	46,49	101,36	-	-

¹⁾ Momentum degree of fullness without contribution from channel dead weight

²⁾ Size of designated system's single load

³⁾ Dimensions in mm and inch

Symbols and designation see Annex D1

Hilti MT installation channels

Bending characteristics of the channel in case of fire

Annex D21

Table D40: Calculation-based deformation in case of fire for installation channels MT-50, MT-50 S, MT-50 OC and MT-50 S OC

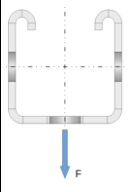
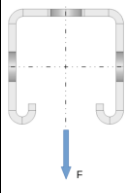
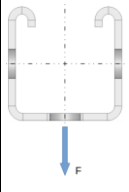
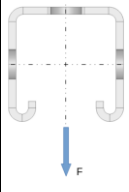
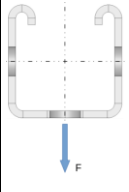
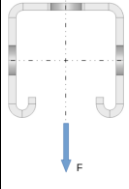
System			Load direction	σ_B	$V^{1)}$	$F^{2)}$	$\delta_{t_{max},B}$	$t_{max,B}$	δ_{30}	δ_{60}	δ_{90}	δ_{120}
Loadcase	L ³⁾	n		MPa	-	N	mm	min	mm	mm	mm	mm
1	900	-		5	0,50	61,59	24,43	120,00	13,87	19,18	24,43	24,43
				10	0,50	132,76	51,51	120,00	22,59	36,65	47,25	51,51
				15	0,50	203,93	181,22	120,00	31,40	57,08	93,17	181,22
				20	0,50	275,10	238,05	120,00	40,22	87,12	205,02	238,05
				25	0,50	346,28	273,17	120,00	49,20	179,15	245,05	273,17
				30	0,50	417,45	299,31	120,00	61,64	217,52	273,58	299,31
1	900	-		5	0,50	61,59	24,33	120,00	13,86	19,13	24,33	24,33
				10	0,50	132,76	50,70	120,00	22,54	36,41	46,84	50,70
				15	0,50	203,93	92,90	120,00	31,28	56,33	77,08	92,90
				20	0,50	275,10	150,23	113,33	39,99	76,97	118,85	-
				25	0,50	346,28	141,64	80,00	48,74	98,85	-	-
				30	0,50	417,45	144,02	66,67	58,12	124,90	-	-
2	900	-		5	0,89	138,58	32,30	120,00	17,34	25,49	32,30	32,30
				10	0,89	298,72	138,36	120,00	30,16	86,28	121,58	138,36
				15	0,89	458,85	133,34	60,00	54,29	133,34	-	-
				20	0,89	618,99	42,60	26,67	-	-	-	-
				25	0,89	779,12	14,30	20,00	-	-	-	-
				30	0,89	939,26	17,35	20,00	-	-	-	-
2	900	-		5	0,89	138,58	32,19	120,00	17,34	25,50	32,19	32,19
				10	0,89	298,72	75,18	120,00	30,14	52,02	66,44	75,18
				15	0,89	458,85	120,51	120,00	42,72	79,34	106,02	120,51
				20	0,89	618,99	160,37	120,00	54,92	103,27	141,79	160,37
				25	0,89	779,12	184,14	113,33	66,89	124,93	168,09	-
				30	0,89	939,26	192,17	93,33	79,93	143,82	189,30	-
3	900	7		5	0,67	13,86	28,86	120,00	15,87	22,76	28,86	28,86
				10	0,67	29,87	64,52	120,00	26,58	44,64	57,52	64,52
				15	0,67	45,89	101,76	93,33	37,28	68,73	98,39	-
				20	0,67	61,90	104,37	66,67	47,84	92,86	-	-
				25	0,67	77,91	88,04	46,67	58,39	-	-	-
				30	0,67	93,93	88,40	33,33	70,66	-	-	-
3	900	7		5	0,67	13,86	28,88	120,00	15,87	22,81	28,88	28,88
				10	0,67	29,87	64,84	120,00	26,71	45,06	57,91	64,84
				15	0,67	45,89	114,33	120,00	37,52	69,61	96,13	114,33
				20	0,67	61,90	166,59	120,00	48,17	93,27	137,86	166,59
				25	0,67	77,91	210,62	120,00	58,77	116,54	172,96	210,62
				30	0,67	93,93	211,25	93,33	70,68	140,46	205,51	-

¹⁾ Momentum degree of fullness without contribution from channel dead weight

²⁾ Size of designated system's single load

³⁾ Dimensions in mm and inch

Symbols and designation see Annex D1

Hilti MT installation channels

Bending characteristics of the channel in case of fire

Annex D22

Table D41: Calculation-based deformation in case of fire for installation channels MT-50, MT-50 S, MT-50 OC and MT-50 S OC

System			Load direction	σ_B	$V^{1)}$	$F^{2)}$	$\delta_{t_{max},B}$	$t_{max,B}$	δ_{30}	δ_{60}	δ_{90}	δ_{120}
Loadcase	$L^3)$	n		MPa	-	N	mm	min	mm	mm	mm	mm
1	1100	-		5	0,50	46,52	35,51	120,00	18,79	28,18	35,51	35,51
				10	0,50	104,75	77,38	120,00	31,69	53,79	68,91	77,38
				15	0,50	162,98	232,92	120,00	44,59	83,58	186,12	232,92
				20	0,50	221,22	102,01	53,33	57,42	-	-	-
				25	0,50	279,45	98,91	40,00	70,55	-	-	-
				30	0,50	337,68	62,35	26,67	-	-	-	-
1	1100	-		5	0,50	46,52	35,29	120,00	18,72	28,01	35,29	35,29
				10	0,50	104,75	75,65	120,00	31,55	53,45	68,27	75,65
				15	0,50	162,98	132,07	120,00	44,40	82,01	110,31	132,07
				20	0,50	221,22	201,86	113,33	57,09	110,50	163,46	-
				25	0,50	279,45	190,74	80,00	69,69	139,21	-	-
				30	0,50	337,68	192,59	66,67	82,91	170,74	-	-
2	1100	-		5	0,91	127,94	69,64	120,00	23,63	37,28	51,26	69,64
				10	0,91	288,07	166,94	120,00	45,83	118,04	151,28	166,94
				15	0,91	448,21	208,96	120,00	82,64	161,63	194,51	208,96
				20	0,91	608,34	66,45	26,67	-	-	-	-
				25	0,91	768,48	19,72	20,00	-	-	-	-
				30	0,91	928,61	24,44	20,00	-	-	-	-
2	1100	-		5	0,91	127,94	46,58	120,00	23,57	36,80	46,06	46,58
				10	0,91	288,07	105,86	120,00	42,44	74,43	93,66	105,86
				15	0,91	448,21	156,11	120,00	60,57	110,19	139,76	156,11
				20	0,91	608,34	198,07	120,00	77,62	139,15	179,18	198,07
				25	0,91	768,48	228,57	120,00	93,81	163,52	207,93	228,57
				30	0,91	928,61	246,28	113,33	109,65	184,15	229,66	-
3	1100	9		5	0,67	8,53	42,16	120,00	21,72	33,36	41,93	42,16
				10	0,67	19,20	93,20	120,00	37,46	64,70	82,35	93,20
				15	0,67	29,88	169,49	100,00	52,91	97,12	141,99	-
				20	0,67	40,56	154,49	73,33	68,64	127,81	-	-
				25	0,67	51,23	121,70	46,67	82,41	-	-	-
				30	0,67	61,91	121,60	33,33	98,42	-	-	-
3	1100	9		5	0,67	8,53	42,02	120,00	21,67	33,37	41,88	42,02
				10	0,67	19,20	94,22	120,00	37,63	65,57	83,31	94,22
				15	0,67	29,88	152,44	120,00	53,35	99,12	131,42	152,44
				20	0,67	40,56	209,35	120,00	68,55	129,35	179,23	209,35
				25	0,67	51,23	251,75	120,00	83,34	157,13	217,57	251,75
				30	0,67	61,91	287,79	120,00	98,86	182,88	248,92	287,79

¹⁾ Momentum degree of fullness without contribution from channel dead weight

²⁾ Size of designated system's single load

³⁾ Dimensions in mm and inch

Symbols and designation see Annex D1

Hilti MT installation channels

Bending characteristics of the channel in case of fire

Annex D23

Table D42: Calculation-based deformation in case of fire for installation channels MT-50, MT-50 S, MT-50 OC and MT-50 S OC

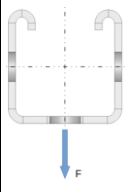
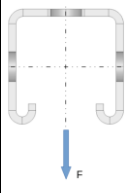
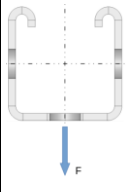
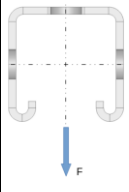
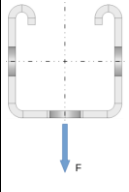
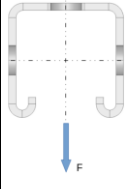
System			Load direction	σ_B	$V^{1)}$	$F^{2)}$	$\delta_{t_{max},B}$	$t_{max,B}$	δ_{30}	δ_{60}	δ_{90}	δ_{120}
Loadcase	$L^3)$	n		MPa	-	N	mm	min	mm	mm	mm	mm
1	1300	-		5	0,50	35,44	50,34	120,00	25,05	39,53	49,47	50,34
				10	0,50	84,71	110,76	120,00	42,85	74,60	95,11	110,76
				15	0,50	133,98	299,78	120,00	60,52	117,38	254,76	299,78
				20	0,50	183,25	115,26	46,67	77,98	-	-	-
				25	0,50	232,52	119,54	33,33	95,25	-	-	-
				30	0,50	281,80	84,75	26,67	-	-	-	-
1	1300	-		5	0,50	35,44	50,00	120,00	24,90	39,29	49,17	50,00
				10	0,50	84,71	105,56	120,00	42,67	74,21	94,15	105,56
				15	0,50	133,98	175,33	120,00	60,29	112,15	148,12	175,33
				20	0,50	183,25	256,98	113,33	77,52	148,52	211,44	-
				25	0,50	232,52	242,90	80,00	94,39	183,66	-	-
				30	0,50	281,80	244,50	66,67	111,70	219,94	-	-
2	1300	-		5	0,92	115,16	102,17	120,00	31,30	56,59	87,55	102,17
				10	0,92	275,30	197,57	120,00	68,95	145,84	179,80	197,57
				15	0,92	435,43	241,56	120,00	110,98	190,82	224,88	241,56
				20	0,92	595,57	262,49	120,00	152,69	216,30	248,21	262,49
				25	0,92	755,70	281,76	120,00	181,47	238,04	268,71	281,76
				30	0,92	915,84	301,03	120,00	210,25	259,79	289,21	301,03
2	1300	-		5	0,92	115,16	64,39	120,00	31,00	50,14	62,34	64,39
				10	0,92	275,30	138,69	120,00	56,87	99,42	123,47	138,69
				15	0,92	435,43	194,19	120,00	81,02	142,85	175,09	194,19
				20	0,92	595,57	237,81	120,00	103,06	176,41	217,72	237,81
				25	0,92	755,70	270,36	120,00	123,41	203,12	249,10	270,36
				30	0,92	915,84	297,44	120,00	142,23	225,47	272,82	297,44
3	1300	11		5	0,67	5,48	59,91	120,00	29,08	46,52	58,07	59,91
				10	0,67	13,11	125,36	120,00	50,63	87,98	110,62	125,36
				15	0,67	20,73	292,41	120,00	71,27	128,12	205,04	292,41
				20	0,67	28,36	348,80	120,00	90,79	184,70	310,77	348,80
				25	0,67	35,99	384,34	120,00	109,53	262,82	350,60	384,34
				30	0,67	43,61	186,45	40,00	127,94	-	-	-
3	1300	11		5	0,67	5,48	59,64	120,00	28,91	46,47	57,95	59,64
				10	0,67	13,11	127,34	120,00	50,90	89,60	112,53	127,34
				15	0,67	20,73	191,96	120,00	72,07	131,68	168,55	191,96
				20	0,67	28,36	252,24	120,00	92,15	167,59	221,11	252,24
				25	0,67	35,99	298,34	120,00	111,27	199,12	262,65	298,34
				30	0,67	43,61	334,07	120,00	130,15	226,91	296,39	334,07

¹⁾ Momentum degree of fullness without contribution from channel dead weight

²⁾ Size of designated system's single load

³⁾ Dimensions in mm and inch

Symbols and designation see Annex D1

Hilti MT installation channels

Bending characteristics of the channel in case of fire

Annex D24

Table D43: Calculation-based deformation in case of fire for installation channels MT-50, MT-50 S, MT-50 OC and MT-50 S OC

System			Load direction	σ_B	$V^{1)}$	$F^{2)}$	$\delta_{t_{max},B}$	$t_{max,B}$	δ_{30}	δ_{60}	δ_{90}	δ_{120}
Loadcase	$L^{3)}$	n		MPa	-	N	mm	min	mm	mm	mm	mm
1	1500	-		5	0,50	26,74	69,18	120,00	32,82	53,55	66,66	69,18
				10	0,50	69,44	156,55	120,00	56,23	99,36	128,32	156,55
				15	0,50	112,14	367,21	120,00	79,27	211,60	319,11	367,21
				20	0,50	154,84	138,88	40,00	102,11	-	-	-
				25	0,50	197,55	92,90	26,67	-	-	-	-
				30	0,50	240,25	110,95	26,67	-	-	-	-
1	1500	-		5	0,50	26,74	68,76	120,00	32,60	53,23	66,29	68,76
				10	0,50	69,44	140,16	120,00	56,02	98,71	124,36	140,16
				15	0,50	112,14	221,93	120,00	78,99	146,31	189,72	221,93
				20	0,50	154,84	313,11	113,33	101,16	190,30	262,15	-
				25	0,50	197,55	297,15	80,00	122,62	231,42	-	-
				30	0,50	240,25	298,68	66,67	144,11	271,93	-	-
2	1500	-		5	0,93	100,26	127,09	120,00	40,94	85,50	114,48	127,09
				10	0,93	260,40	236,47	120,00	90,37	173,01	214,01	236,47
				15	0,93	420,53	282,98	120,00	138,78	223,88	263,32	282,98
				20	0,93	580,67	294,93	120,00	175,48	244,97	279,04	294,93
				25	0,93	740,80	314,56	120,00	205,20	268,02	300,53	314,56
				30	0,93	900,94	337,27	120,00	236,15	293,12	324,57	337,27
2	1500	-		5	0,93	100,26	84,66	120,00	39,59	65,40	80,89	84,66
				10	0,93	260,40	173,32	120,00	73,24	126,50	155,31	173,32
				15	0,93	420,53	234,91	120,00	103,71	176,89	212,13	234,91
				20	0,93	580,67	279,58	120,00	130,71	214,67	257,60	279,58
				25	0,93	740,80	314,39	120,00	155,03	243,98	291,77	314,39
				30	0,93	900,94	341,28	120,00	176,90	267,89	317,62	341,28
3	1500	13		5	0,67	3,58	81,20	120,00	38,13	62,43	77,46	81,20
				10	0,67	9,30	161,03	120,00	66,02	113,81	141,50	161,03
				15	0,67	15,02	302,22	120,00	92,10	161,24	225,03	302,22
				20	0,67	20,74	386,93	120,00	116,20	215,37	334,92	386,93
				25	0,67	26,46	429,91	120,00	139,35	282,47	389,36	429,91
				30	0,67	32,18	461,08	120,00	170,29	351,56	423,66	461,08
3	1500	13		5	0,67	3,58	80,83	120,00	37,77	62,32	77,29	80,83
				10	0,67	9,30	163,12	120,00	66,46	116,60	144,74	163,12
				15	0,67	15,02	232,89	120,00	93,49	166,35	206,97	232,89
				20	0,67	20,74	295,33	120,00	118,50	207,12	263,13	295,33
				25	0,67	26,46	344,69	120,00	141,84	241,72	307,81	344,69
				30	0,67	32,18	383,46	120,00	163,95	271,88	343,97	383,46

¹⁾ Momentum degree of fullness without contribution from channel dead weight

²⁾ Size of designated system's single load

³⁾ Dimensions in mm and inch



Symbols and designation see Annex D1

Hilti MT installation channels

Bending characteristics of the channel in case of fire

Annex D25

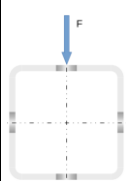
Table D44: Calculation-based deformation in case of fire for installation channels MT-70 S OC and MT-70 OC

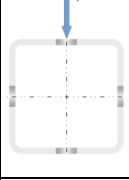
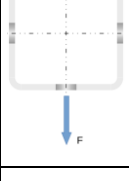
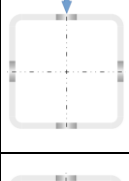
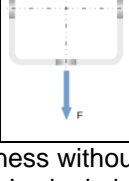
System			Load direction	σ_B	$V^{(1)}$	$F^{(2)}$	$\delta_{t_{max};B}$	$t_{max,B}$	δ_{30}	δ_{60}	δ_{90}	δ_{120}
Loadcase	$L^{(3)}$	n		MPa	-	N	mm	min	mm	mm	mm	mm
1	500	-		5	0,50	247,05	32,35	120,00	7,01	32,35	32,35	32,35
				10	0,50	502,41	38,36	120,00	8,14	38,36	38,36	38,36
				15	0,50	757,77	51,59	120,00	9,72	46,90	46,90	51,59
				20	0,50	1013,13	156,46	120,00	12,34	62,06	80,63	156,46
				25	0,50	1268,49	195,33	120,00	17,55	88,46	170,56	195,33
				30	0,50	1523,85	210,65	120,00	27,60	155,54	199,01	210,65
1	500	-		5	0,50	247,05	33,21	120,00	7,35	33,21	33,21	33,21
				10	0,50	502,41	40,17	120,00	9,05	40,17	40,17	40,17
				15	0,50	757,77	48,64	120,00	11,37	48,64	48,64	48,64
				20	0,50	1013,13	87,28	120,00	14,52	61,32	66,88	87,28
				25	0,50	1268,49	152,03	120,00	19,08	80,44	107,53	152,03
				30	0,50	1523,85	204,09	120,00	26,54	107,19	158,87	204,09
2	500	-		5	0,80	308,81	34,80	120,00	7,45	34,80	34,80	34,80
				10	0,80	628,01	44,09	120,00	9,33	44,09	44,09	44,09
				15	0,80	947,21	89,44	120,00	12,11	62,12	71,78	89,44
				20	0,80	1266,41	126,51	120,00	17,81	92,92	111,00	126,51
				25	0,80	1585,61	146,44	120,00	32,42	123,99	136,97	146,44
				30	0,80	1904,81	151,99	90,91	58,28	146,85	151,37	-
2	500	-		5	0,80	308,81	34,60	120,00	7,44	34,60	34,60	34,60
				10	0,80	628,01	42,86	120,00	9,23	42,86	42,86	42,86
				15	0,80	947,21	64,64	120,00	11,58	55,84	55,84	64,64
				20	0,80	1266,41	99,95	120,00	15,83	75,67	84,86	99,95
				25	0,80	1585,61	124,97	117,77	25,13	100,20	111,00	-
				30	0,80	1904,81	132,35	86,10	40,33	120,99	-	-
3	500	3		5	0,67	102,94	33,77	120,00	7,27	33,77	33,77	33,77
				10	0,67	209,34	41,46	120,00	8,80	41,46	41,46	41,46
				15	0,67	315,74	76,61	120,00	10,82	53,94	57,32	76,61
				20	0,67	422,14	138,95	120,00	14,43	78,29	107,97	138,95
				25	0,67	528,54	184,65	120,00	22,94	115,77	155,14	184,65
				30	0,67	634,94	206,49	120,00	40,89	155,52	188,56	206,49
3	500	3		5	0,67	102,94	33,74	120,00	7,28	33,74	33,74	33,74
				10	0,67	209,34	41,12	120,00	8,81	41,12	41,12	41,12
				15	0,67	315,74	58,64	120,00	10,77	51,80	51,80	58,64
				20	0,67	422,14	101,04	120,00	14,07	69,47	81,67	101,04
				25	0,67	528,54	138,89	120,00	20,88	94,70	117,43	138,89
				30	0,67	634,94	167,03	120,00	33,06	122,34	145,78	167,03

¹⁾ Momentum degree of fullness without contribution from channel dead weight

²⁾ Size of designated system's single load

³⁾ Dimensions in mm and inch



Symbols and designation see Annex D1

Hilti MT installation channels

Bending characteristics of the channel in case of fire

Annex D26

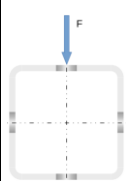
Table D45: Calculation-based deformation in case of fire for installation channels MT-70 S OC and MT-70 OC

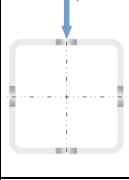
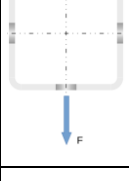
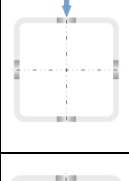
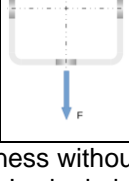
System			Load direction	σ_B	$V^{1)}$	$F^{2)}$	$\delta_{t_{max};B}$	$t_{max,B}$	δ_{30}	δ_{60}	δ_{90}	δ_{120}
Loadcase	$L^{3)}$	n		MPa	-	N	mm	min	mm	mm	mm	mm
1	800	-		5	0,50	146,30	37,15	120,00	8,03	37,15	37,15	37,15
				10	0,50	305,90	51,36	120,00	10,79	51,36	51,36	51,36
				15	0,50	465,50	104,98	120,00	14,35	70,27	83,77	104,98
				20	0,50	625,10	188,53	120,00	19,81	101,73	143,75	188,53
				25	0,50	784,70	287,59	120,00	30,42	146,59	216,85	287,59
				30	0,50	944,30	328,95	120,00	50,99	199,96	291,64	328,95
1	800	-		5	0,50	146,30	37,59	120,00	8,21	37,59	37,59	37,59
				10	0,50	305,90	52,26	120,00	11,24	52,26	52,26	52,26
				15	0,50	465,50	97,60	120,00	15,13	70,67	81,20	97,60
				20	0,50	625,10	166,31	120,00	20,78	99,10	132,52	166,31
				25	0,50	784,70	230,37	120,00	30,49	138,44	189,70	230,37
				30	0,50	944,30	288,75	120,00	47,64	181,46	240,91	288,75
2	800	-		5	0,88	292,60	43,33	120,00	9,08	43,33	43,33	43,33
				10	0,88	611,80	90,19	120,00	13,76	67,02	75,78	90,19
				15	0,88	931,00	160,84	120,00	20,48	110,06	140,50	160,84
				20	0,88	1250,20	205,97	120,00	34,67	159,09	187,44	205,97
				25	0,88	1569,40	228,43	120,00	71,07	198,04	215,41	228,43
				30	0,88	1888,60	232,96	96,35	114,76	223,65	231,31	-
2	800	-		5	0,88	292,60	42,77	120,00	9,05	42,77	42,77	42,77
				10	0,88	611,80	75,64	120,00	13,56	63,70	66,53	75,64
				15	0,88	931,00	121,54	120,00	19,51	93,48	108,82	121,54
				20	0,88	1250,20	161,78	120,00	30,49	128,95	148,58	161,78
				25	0,88	1569,40	185,20	119,26	53,27	159,84	174,52	-
				30	0,88	1888,60	192,40	86,74	82,82	183,55	-	-
3	800	6		5	0,67	36,57	39,96	120,00	8,52	39,96	39,96	39,96
				10	0,67	76,47	66,72	120,00	12,13	58,08	58,37	66,72
				15	0,67	116,37	135,21	120,00	16,79	84,91	109,54	135,21
				20	0,67	156,27	206,64	120,00	24,72	127,76	171,73	206,64
				25	0,67	196,17	258,44	120,00	42,19	178,22	226,12	258,44
				30	0,67	236,07	301,74	120,00	74,97	221,82	266,99	301,74
3	800	6		5	0,67	36,57	39,97	120,00	8,56	39,97	39,97	39,97
				10	0,67	76,47	63,97	120,00	12,21	57,74	57,74	63,97
				15	0,67	116,37	119,67	120,00	16,86	82,23	100,40	119,67
				20	0,67	156,27	182,25	120,00	24,53	118,83	153,63	182,25
				25	0,67	196,17	225,13	120,00	40,12	161,71	198,90	225,13
				30	0,67	236,07	257,18	120,00	67,32	198,63	234,53	257,18

¹⁾ Momentum degree of fullness without contribution from channel dead weight

²⁾ Size of designated system's single load

³⁾ Dimensions in mm and inch



Symbols and designation see Annex D1

Hilti MT installation channels

Bending characteristics of the channel in case of fire

Annex D27

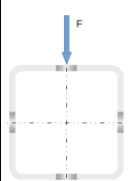
Table D46: Calculation-based deformation in case of fire for installation channels MT-70 S OC and MT-70 OC

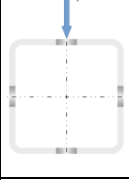
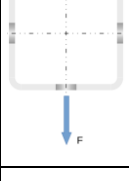
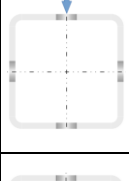
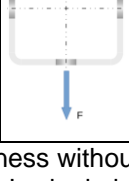
System			Load direction	σ_B	$V^{1)}$	$F^{2)}$	$\delta_{t_{max};B}$	$t_{max,B}$	δ_{30}	δ_{60}	δ_{90}	δ_{120}
Loadcase	$L^3)$	n		MPa	-	N	mm	min	mm	mm	mm	mm
1	1100	-		5	0,50	97,78	44,47	120,00	9,57	44,47	44,47	44,47
				10	0,50	213,85	90,08	120,00	14,71	70,67	79,48	90,08
				15	0,50	329,93	170,78	120,00	21,23	103,99	140,03	170,78
				20	0,50	446,00	265,95	120,00	31,02	154,31	218,39	265,95
				25	0,50	562,07	357,23	120,00	49,47	216,07	294,52	357,23
				30	0,50	678,15	429,03	120,00	83,56	277,03	366,09	429,03
1	1100	-		5	0,50	97,78	44,71	120,00	9,68	44,71	44,71	44,71
				10	0,50	213,85	89,97	120,00	14,98	71,12	79,75	89,97
				15	0,50	329,93	164,55	120,00	21,69	103,81	137,45	164,55
				20	0,50	446,00	253,90	120,00	31,52	151,68	210,69	253,90
				25	0,50	562,07	322,83	120,00	49,02	209,61	278,99	322,83
				30	0,50	678,15	382,96	120,00	79,99	264,61	335,99	382,96
2	1100	-		5	0,91	268,90	55,51	120,00	11,38	55,51	55,51	55,51
				10	0,91	588,10	155,74	120,00	20,19	100,15	131,71	155,74
				15	0,91	907,30	236,04	120,00	32,82	169,15	213,11	236,04
				20	0,91	1226,50	289,73	120,00	59,95	229,94	269,43	289,73
				25	0,91	1545,70	316,31	120,00	118,75	272,79	301,35	316,31
				30	0,91	1864,90	324,77	99,78	177,03	304,89	322,28	-
2	1100	-		5	0,91	268,90	54,19	120,00	11,32	54,19	54,19	54,19
				10	0,91	588,10	128,59	120,00	19,76	92,55	112,91	128,59
				15	0,91	907,30	183,94	120,00	30,85	139,04	166,72	183,94
				20	0,91	1226,50	226,11	120,00	51,05	186,85	212,57	226,11
				25	0,91	1545,70	249,89	120,00	88,10	221,42	241,50	249,89
				30	0,91	1864,90	258,55	88,59	128,57	246,83	-	-
3	1100	9		5	0,67	17,93	49,62	120,00	10,47	49,62	49,62	49,62
				10	0,67	39,21	119,82	120,00	17,31	83,49	102,56	119,82
				15	0,67	60,49	210,61	120,00	26,21	131,06	178,51	210,61
				20	0,67	81,77	295,09	120,00	41,55	194,51	255,54	295,09
				25	0,67	103,05	350,43	120,00	74,72	257,63	313,76	350,43
				30	0,67	124,33	389,04	120,00	128,76	307,45	359,45	389,04
3	1100	9		5	0,67	17,93	49,45	120,00	10,47	49,45	49,45	49,45
				10	0,67	39,21	114,95	120,00	17,26	82,45	99,51	114,95
				15	0,67	60,49	193,74	120,00	26,01	126,18	166,73	193,74
				20	0,67	81,77	270,45	120,00	40,72	183,19	236,88	270,45
				25	0,67	103,05	322,62	120,00	70,47	239,32	288,62	322,62
				30	0,67	124,33	358,62	120,00	117,19	285,40	329,77	358,62

¹⁾ Momentum degree of fullness without contribution from channel dead weight

²⁾ Size of designated system's single load

³⁾ Dimensions in mm and inch





Symbols and designation see Annex D1

Hilti MT installation channels

Bending characteristics of the channel in case of fire

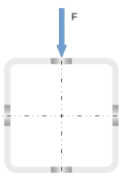
Annex D28

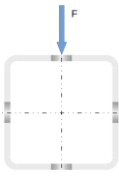
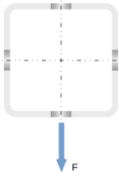
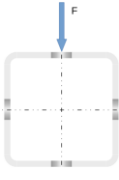
Table D47: Calculation-based deformation in case of fire for installation channels MT-70 S OC and MT-70 OC

System			Load direction	σ_B	$V^{(1)}$	$F^{(2)}$	$\delta_{t_{max},B}$	$t_{max,B}$	δ_{30}	δ_{60}	δ_{90}	δ_{120}
Loadcase	$L^{(3)}$	n		MPa	-	N	mm	min	mm	mm	mm	mm
1	1400	-		5	0,50	67,92	54,74	120,00	11,73	54,74	54,74	54,74
				10	0,50	159,12	142,09	120,00	20,02	96,57	123,77	142,09
				15	0,50	250,32	245,97	120,00	30,50	147,49	207,15	245,97
				20	0,50	341,52	355,17	120,00	46,11	217,35	301,21	355,17
				25	0,50	432,72	441,62	120,00	74,90	293,35	384,18	441,62
				30	0,50	523,92	518,66	120,00	125,26	361,86	453,77	518,66
1	1400	-		5	0,50	67,92	54,85	120,00	11,79	54,85	54,85	54,85
				10	0,50	159,12	141,66	120,00	20,19	96,74	123,69	141,66
				15	0,50	250,32	241,24	120,00	30,76	146,97	204,90	241,24
				20	0,50	341,52	346,34	120,00	46,31	215,08	296,28	346,34
				25	0,50	432,72	424,05	120,00	74,09	288,31	373,15	424,05
				30	0,50	523,92	484,16	120,00	121,76	353,68	437,07	484,16
2	1400	-		5	0,93	237,72	78,46	120,00	14,30	70,84	78,29	78,46
				10	0,93	556,92	227,82	120,00	28,54	141,73	196,03	227,82
				15	0,93	876,12	314,93	120,00	49,05	233,09	288,77	314,93
				20	0,93	1195,32	377,06	120,00	92,91	305,91	353,78	377,06
				25	0,93	1514,52	410,55	120,00	177,30	354,16	392,80	410,55
				30	0,93	1833,72	419,50	102,67	241,32	388,45	415,60	-
2	1400	-		5	0,93	237,72	71,32	120,00	14,20	68,54	71,32	71,32
				10	0,93	556,92	187,55	120,00	27,75	128,14	166,28	187,55
				15	0,93	876,12	255,33	120,00	45,48	189,49	229,68	255,33
				20	0,93	1195,32	296,37	120,00	76,79	247,30	280,33	296,37
				25	0,93	1514,52	320,84	120,00	127,33	287,74	312,36	320,84
				30	0,93	1833,72	330,23	91,17	178,19	315,43	329,56	-
3	1400	12		5	0,67	9,70	61,83	120,00	12,96	61,83	61,83	61,83
				10	0,67	22,73	180,34	120,00	23,85	114,95	154,70	180,34
				15	0,67	35,76	285,87	120,00	38,00	182,92	249,05	285,87
				20	0,67	48,79	381,63	120,00	62,04	263,59	339,37	381,63
				25	0,67	61,82	446,39	120,00	111,17	335,73	403,85	446,39
				30	0,67	74,85	490,85	120,00	183,11	393,90	453,15	490,85
3	1400	12		5	0,67	9,70	61,63	120,00	12,96	61,63	61,63	61,63
				10	0,67	22,73	174,43	120,00	23,80	113,57	150,82	174,43
				15	0,67	35,76	270,16	120,00	37,76	177,01	237,14	270,16
				20	0,67	48,79	358,58	120,00	60,93	252,16	320,95	358,58
				25	0,67	61,82	420,09	120,00	105,68	317,90	381,99	420,09
				30	0,67	74,85	463,10	120,00	170,07	372,41	426,98	463,10

¹⁾ Momentum degree of fullness without contribution from channel dead weight

²⁾ Size of designated system's single load

³⁾ Dimensions in mm and inch



Symbols and designation see Annex D1

Hilti MT installation channels

Bending characteristics of the channel in case of fire

Annex D29

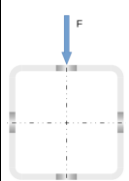
Table D48: Calculation-based deformation in case of fire for installation channels MT-70 S OC and MT-70 OC

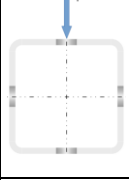
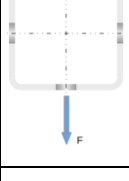
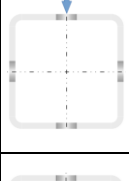
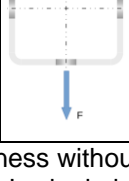
System			Load direction	σ_B	$V^{(1)}$	$F^{(2)}$	$\delta_{t_{max};B}$	$t_{max,B}$	δ_{30}	δ_{60}	δ_{90}	δ_{120}
Loadcase	$L^{(3)}$	n		MPa	-	N	mm	min	mm	mm	mm	mm
1	1700	-		5	0,50	46,84	69,94	120,00	14,60	68,64	69,94	69,94
				10	0,50	121,94	204,84	120,00	26,85	129,43	178,09	204,84
				15	0,50	197,05	328,64	120,00	42,31	199,97	282,63	328,64
				20	0,50	272,16	449,22	120,00	65,25	288,58	390,65	449,22
				25	0,50	347,26	538,95	120,00	106,73	376,39	479,49	538,95
				30	0,50	422,37	614,38	120,00	175,02	452,62	553,18	614,38
1	1700	-		5	0,50	46,84	69,89	120,00	14,64	68,66	69,89	69,89
				10	0,50	121,94	204,21	120,00	26,94	129,39	177,78	204,21
				15	0,50	197,05	325,06	120,00	42,44	199,21	280,66	325,06
				20	0,50	272,16	442,39	120,00	65,22	286,64	386,88	442,39
				25	0,50	347,26	529,51	120,00	105,59	372,33	471,65	529,51
				30	0,50	422,37	592,73	120,00	171,58	447,06	541,47	592,73
2	1700	-		5	0,94	199,06	109,90	120,00	17,78	88,73	108,26	109,90
				10	0,94	518,26	303,22	120,00	38,71	189,58	264,87	303,22
				15	0,94	837,46	401,53	120,00	69,02	299,93	367,24	401,53
				20	0,94	1156,66	466,63	120,00	132,09	384,16	440,74	466,63
				25	0,94	1475,86	507,07	120,00	236,40	438,46	485,68	507,07
				30	0,94	1795,06	518,54	105,72	307,91	474,73	511,91	-
2	1700	-		5	0,94	199,06	98,73	120,00	17,63	85,46	98,73	98,73
				10	0,94	518,26	251,34	120,00	37,44	169,29	224,87	251,34
				15	0,94	837,46	330,79	120,00	63,23	243,87	300,24	330,79
				20	0,94	1156,66	376,42	120,00	107,01	311,08	351,88	376,42
				25	0,94	1475,86	401,45	120,00	169,95	356,87	388,11	401,45
				30	0,94	1795,06	408,28	94,69	230,59	388,17	407,08	-
3	1700	15		5	0,67	5,53	86,08	120,00	16,16	77,60	86,08	86,08
				10	0,67	14,40	250,27	120,00	32,25	154,14	216,36	250,27
				15	0,67	23,26	369,34	120,00	53,18	243,65	327,36	369,34
				20	0,67	32,13	473,79	120,00	88,56	340,78	428,77	473,79
				25	0,67	41,00	546,64	120,00	157,03	420,45	501,97	546,64
				30	0,67	49,86	597,20	120,00	246,32	485,67	554,77	597,20
3	1700	15		5	0,67	5,53	85,23	120,00	16,15	77,31	85,23	85,23
				10	0,67	14,40	243,38	120,00	32,14	152,23	211,60	243,38
				15	0,67	23,26	354,74	120,00	52,77	236,62	315,20	354,74
				20	0,67	32,13	451,39	120,00	86,89	328,37	410,16	451,39
				25	0,67	41,00	520,79	120,00	149,86	402,53	479,92	520,79
				30	0,67	49,86	569,71	120,00	231,67	464,05	530,59	569,71

¹⁾ Momentum degree of fullness without contribution from channel dead weight

²⁾ Size of designated system's single load

³⁾ Dimensions in mm and inch



Symbols and designation see Annex D1

Hilti MT installation channels

Bending characteristics of the channel in case of fire

Annex D30

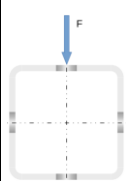
Table D49: Calculation-based deformation in case of fire for installation channels MT-70 S OC and MT-70 OC

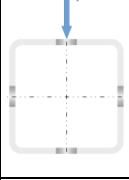
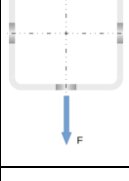
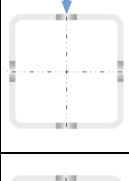
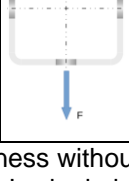
System			Load direction	σ_B	$V^{1)}$	$F^{2)}$	$\delta_{t_{max};B}$	$t_{max,B}$	δ_{30}	δ_{60}	δ_{90}	δ_{120}
Loadcase	$L^3)$	n		MPa	-	N	mm	min	mm	mm	mm	mm
1	2000	-		5	0,50	30,58	99,99	120,00	18,35	86,97	99,99	99,99
				10	0,50	94,42	277,12	120,00	35,40	169,60	241,74	277,12
				15	0,50	158,26	417,36	120,00	56,88	260,37	364,62	417,36
				20	0,50	222,10	546,67	120,00	88,66	366,19	484,33	546,67
				25	0,50	285,94	644,10	120,00	144,85	463,89	579,38	644,10
				30	0,50	349,78	717,60	120,00	231,73	547,96	657,26	717,60
1	2000	-		5	0,50	30,58	99,86	120,00	18,36	86,93	99,86	99,86
				10	0,50	94,42	276,38	120,00	35,43	169,40	241,26	276,38
				15	0,50	158,26	414,68	120,00	56,89	259,45	362,91	414,68
				20	0,50	222,10	541,40	120,00	88,43	364,44	481,24	541,40
				25	0,50	285,94	636,96	120,00	143,42	460,56	574,24	636,96
				30	0,50	349,78	706,05	120,00	228,32	543,49	648,44	706,05
2	2000	-		5	0,95	152,92	142,95	120,00	21,71	108,34	139,97	142,95
				10	0,95	472,12	380,79	120,00	50,55	241,64	336,23	380,79
				15	0,95	791,32	493,91	120,00	92,41	368,74	448,30	493,91
				20	0,95	1110,52	559,08	120,00	175,95	464,18	530,48	559,08
				25	0,95	1429,72	603,59	120,00	297,78	525,98	581,32	603,59
				30	0,95	1748,92	621,31	110,18	377,74	566,21	611,58	-
2	2000	-		5	0,95	152,92	130,08	120,00	21,55	104,58	129,38	130,08
				10	0,95	472,12	320,01	120,00	48,73	215,12	288,09	320,01
				15	0,95	791,32	410,89	120,00	83,92	302,36	375,57	410,89
				20	0,95	1110,52	461,69	120,00	141,12	378,54	429,59	461,69
				25	0,95	1429,72	489,49	120,00	215,65	429,74	467,18	489,49
				30	0,95	1748,92	492,54	99,12	285,81	464,59	489,30	-
3	2000	18		5	0,67	3,06	117,05	120,00	19,99	96,34	116,61	117,05
				10	0,67	9,44	323,90	120,00	42,11	198,53	282,73	323,90
				15	0,67	15,83	456,93	120,00	70,87	307,58	407,78	456,93
				20	0,67	22,21	565,98	120,00	118,62	418,93	518,14	565,98
				25	0,67	28,59	646,13	120,00	205,08	505,78	599,47	646,13
				30	0,67	34,98	702,80	120,00	309,33	577,22	658,49	702,80
3	2000	18		5	0,67	3,06	116,03	120,00	19,98	96,04	115,76	116,03
				10	0,67	9,44	316,78	120,00	41,99	196,33	277,64	316,78
				15	0,67	15,83	444,49	120,00	70,38	300,16	396,15	444,49
				20	0,67	22,21	545,12	120,00	116,55	406,31	500,28	545,12
				25	0,67	28,59	621,64	120,00	196,92	489,01	578,10	621,64
				30	0,67	34,98	676,52	120,00	294,36	556,41	635,14	676,52

¹⁾ Momentum degree of fullness without contribution from channel dead weight

²⁾ Size of designated system's single load

³⁾ Dimensions in mm and inch





Symbols and designation see Annex D1

Hilti MT installation channels

Bending characteristics of the channel in case of fire

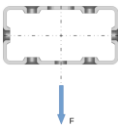
Annex D31

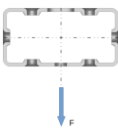
Table D50: Calculation-based deformation in case of fire for installation channels MT-80 S OC and MT-80 OC

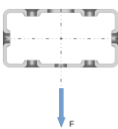
System			Load direction	σ_B	$V^{1)}$	$F^{2)}$	$\delta_{t_{max};B}$	$t_{max,B}$	δ_{30}	δ_{60}	δ_{90}	δ_{120}
Loadcase	$L^{3)}$	n		MPa	-	N	mm	min	mm	mm	mm	mm
1	500	-		5	0,50	695,64	33,01	120,00	3,91	30,49	30,49	33,01
				10	0,50	1402,76	50,48	120,00	4,84	33,95	37,76	50,48
				15	0,50	2109,88	45,66	70,00	6,15	39,48	-	-
				20	0,50	2817,00	32,97	46,67	8,58	-	-	-
				25	0,50	3524,12	12,65	26,67	-	-	-	-
				30	0,50	4231,24	5,59	20,00	-	-	-	-
1	500	-		5	0,50	382,28	33,62	120,00	4,06	31,01	31,01	33,62
				10	0,50	776,04	47,93	120,00	5,26	35,86	40,97	47,93
				15	0,50	1169,80	83,59	120,00	6,89	42,92	58,57	83,59
				20	0,50	1563,56	166,18	120,00	9,55	54,26	102,55	166,18
				25	0,50	1957,32	196,80	120,00	14,50	74,38	162,61	196,80
				30	0,50	2351,08	213,12	120,00	24,49	128,76	188,32	213,12
2	500	-		5	0,80	869,55	37,31	120,00	4,50	32,31	33,44	37,31
				10	0,80	1753,45	47,60	80,00	6,22	38,77	-	-
				15	0,80	2637,35	35,52	48,33	9,35	-	-	-
				20	0,80	3521,25	22,29	30,00	22,29	-	-	-
				25	0,80	4405,15	14,87	21,67	-	-	-	-
				30	0,80	5289,05	7,96	18,33	-	-	-	-
2	500	-		5	0,80	477,85	37,91	120,00	4,87	33,34	34,55	37,91
				10	0,80	970,05	59,61	120,00	6,90	40,77	49,86	59,61
				15	0,80	1462,25	92,47	120,00	10,00	51,18	71,92	92,47
				20	0,80	1954,45	125,08	120,00	14,78	66,66	99,64	125,08
				25	0,80	2446,65	145,57	120,00	22,73	85,89	122,61	145,57
				30	0,80	2938,85	157,86	120,00	35,77	104,68	138,40	157,86
3	500	3		5	0,67	289,85	34,53	120,00	4,24	31,42	31,47	34,53
				10	0,67	584,48	49,08	120,00	5,42	35,90	41,32	49,08
				15	0,67	879,12	55,15	78,33	7,09	42,91	-	-
				20	0,67	1173,75	48,14	55,00	9,69	-	-	-
				25	0,67	1468,38	34,51	40,00	14,38	-	-	-
				30	0,67	1763,02	23,40	28,33	-	-	-	-
3	500	3		5	0,67	159,28	35,97	120,00	4,61	32,55	32,94	35,97
				10	0,67	323,35	53,63	120,00	6,31	38,76	45,94	53,63
				15	0,67	487,42	89,12	120,00	8,53	47,23	66,05	89,12
				20	0,67	651,48	153,84	120,00	11,72	60,54	99,99	153,84
				25	0,67	815,55	189,53	120,00	16,84	81,27	150,90	189,53
				30	0,67	979,62	209,16	120,00	25,74	111,49	180,91	209,16

¹⁾ Momentum degree of fullness without contribution from channel dead weight

²⁾ Size of designated system's single load

³⁾ Dimensions in mm and inch





Symbols and designation see Annex D1

Hilti MT installation channels

Bending characteristics of the channel in case of fire

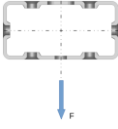
Annex D32

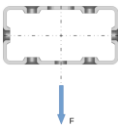
Table D51: Calculation-based deformation in case of fire for installation channels MT-80 S OC and MT-80 OC

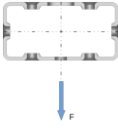
System			Load direction	σ_B	$V^{(1)}$	$F^{(2)}$	$\delta_{t_{max},B}$	$t_{max,B}$	δ_{30}	δ_{60}	δ_{90}	δ_{120}
Loadcase	$L^{(3)}$	n		MPa	-	N	mm	min	mm	mm	mm	mm
1	900	-		5	0,50	372,18	38,41	120,00	5,01	34,19	35,16	38,41
				10	0,50	765,03	62,99	120,00	7,48	43,31	53,95	62,99
				15	0,50	1157,87	96,15	95,00	10,55	55,06	87,24	-
				20	0,50	1550,72	100,05	68,33	14,79	74,99	-	-
				25	0,50	1943,56	73,57	48,33	21,83	-	-	-
				30	0,50	2336,41	43,88	30,00	43,88	-	-	-
1	900	-		5	0,50	198,10	41,58	120,00	5,97	36,76	38,35	41,58
				10	0,50	416,85	72,90	120,00	9,71	49,38	63,00	72,90
				15	0,50	635,61	133,11	120,00	14,01	64,46	98,39	133,11
				20	0,50	854,36	267,87	120,00	19,39	87,31	158,89	267,87
				25	0,50	1073,12	347,89	120,00	27,13	121,99	267,63	347,89
				30	0,50	1291,87	380,84	120,00	40,86	184,85	336,11	380,84
2	900	-		5	0,89	837,42	48,42	120,00	6,39	38,70	44,35	48,42
				10	0,89	1721,32	66,96	70,00	10,40	55,05	-	-
				15	0,89	2605,22	45,18	41,67	17,10	-	-	-
				20	0,89	3489,12	27,43	28,33	-	-	-	-
				25	0,89	4373,02	19,41	21,67	-	-	-	-
				30	0,89	5256,92	11,67	18,33	-	-	-	-
2	900	-		5	0,89	445,72	50,58	120,00	7,73	41,73	46,94	50,58
				10	0,89	937,92	98,64	120,00	13,24	60,94	84,16	98,64
				15	0,89	1430,12	146,26	120,00	20,95	82,99	121,73	146,26
				20	0,89	1922,32	181,70	120,00	31,11	111,00	158,99	181,70
				25	0,89	2414,52	207,74	120,00	44,91	138,12	187,90	207,74
				30	0,89	2906,72	222,06	120,00	62,64	161,27	204,55	222,06
3	900	7		5	0,67	83,74	41,91	120,00	5,68	36,24	38,79	41,91
				10	0,67	172,13	73,67	120,00	8,68	47,62	62,54	73,67
				15	0,67	260,52	89,81	80,00	12,68	63,50	-	-
				20	0,67	348,91	80,90	56,67	17,95	-	-	-
				25	0,67	437,30	63,43	41,67	26,29	-	-	-
				30	0,67	525,69	51,85	31,67	41,51	-	-	-
3	900	7		5	0,67	44,57	46,58	120,00	7,02	39,74	43,22	46,58
				10	0,67	93,79	87,63	120,00	11,88	56,25	75,43	87,63
				15	0,67	143,01	147,23	120,00	17,94	75,70	115,14	147,23
				20	0,67	192,23	230,52	120,00	25,64	102,55	169,76	230,52
				25	0,67	241,45	303,99	120,00	36,37	137,46	232,77	303,99
				30	0,67	290,67	349,64	120,00	52,31	179,76	291,60	349,64

¹⁾ Momentum degree of fullness without contribution from channel dead weight

²⁾ Size of designated system's single load

³⁾ Dimensions in mm and inch



Symbols and designation see Annex D1

Hilti MT installation channels

Bending characteristics of the channel in case of fire

Annex D33

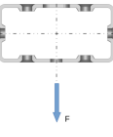
Table D52: Calculation-based deformation in case of fire for installation channels MT-80 S OC and MT-80 OC

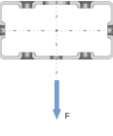
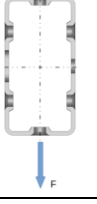
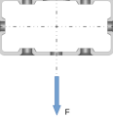
System			Load direction	σ_B	$V^1)$	$F^2)$	$\delta_{t_{max},B}$	$t_{max,B}$	δ_{30}	δ_{60}	δ_{90}	δ_{120}
Loadcase	$L^3)$	n		MPa	-	N	mm	min	mm	mm	mm	mm
1	1300	-		5	0,50	242,13	48,00	120,00	6,89	40,54	44,63	48,00
				10	0,50	514,10	93,62	120,00	11,70	58,34	80,65	93,62
				15	0,50	786,07	182,71	105,00	17,63	80,59	136,98	-
				20	0,50	1058,03	170,61	71,67	25,37	115,22	-	-
				25	0,50	1330,00	146,32	53,33	36,74	-	-	-
				30	0,50	1601,97	116,13	38,33	57,23	-	-	-
1	1300	-		5	0,50	121,60	55,00	120,00	9,06	45,88	51,29	55,00
				10	0,50	273,05	110,47	120,00	16,58	70,40	97,16	110,47
				15	0,50	424,50	191,47	120,00	25,26	97,19	148,91	191,47
				20	0,50	575,94	349,22	120,00	35,81	131,23	234,63	349,22
				25	0,50	727,39	481,09	120,00	49,14	177,04	354,21	481,09
				30	0,50	878,83	542,78	120,00	66,96	253,28	464,02	542,78
2	1300	-		5	0,92	786,91	66,81	120,00	9,38	48,96	62,36	66,81
				10	0,92	1670,81	92,03	63,33	17,16	83,42	-	-
				15	0,92	2554,71	57,77	36,67	29,96	-	-	-
				20	0,92	3438,61	31,31	26,67	-	-	-	-
				25	0,92	4322,51	16,66	20,00	-	-	-	-
				30	0,92	5206,41	17,81	18,33	-	-	-	-
2	1300	-		5	0,92	395,21	68,02	120,00	11,77	53,30	63,88	68,02
				10	0,92	887,41	150,59	120,00	22,44	89,05	130,10	150,59
				15	0,92	1379,61	224,65	120,00	36,85	127,11	189,90	224,65
				20	0,92	1871,81	277,82	120,00	54,93	169,19	241,90	277,82
				25	0,92	2364,01	312,83	120,00	77,30	209,95	286,49	312,83
				30	0,92	2856,21	336,03	120,00	103,18	244,03	317,92	336,03
3	1300	11		5	0,67	37,47	55,11	120,00	8,10	44,38	51,70	55,11
				10	0,67	79,56	118,64	120,00	14,04	67,09	98,97	118,64
				15	0,67	121,65	227,10	81,67	22,06	99,30	-	-
				20	0,67	163,74	165,27	58,33	32,63	-	-	-
				25	0,67	205,83	145,36	43,33	49,41	-	-	-
				30	0,67	247,92	107,85	31,67	81,90	-	-	-
3	1300	11		5	0,67	18,82	63,47	120,00	10,91	50,93	59,51	63,47
				10	0,67	42,26	137,34	120,00	20,46	82,23	118,36	137,34
				15	0,67	65,70	225,20	120,00	32,26	117,06	182,86	225,20
				20	0,67	89,13	327,58	120,00	46,92	161,79	258,81	327,58
				25	0,67	112,57	414,57	120,00	66,30	213,35	333,03	414,57
				30	0,67	136,01	479,56	120,00	93,02	267,96	401,27	479,56

¹⁾ Momentum degree of fullness without contribution from channel dead weight

²⁾ Size of designated system's single load

³⁾ Dimensions in mm and inch



Symbols and designation see Annex D1

Hilti MT installation channels

Bending characteristics of the channel in case of fire

Annex D34

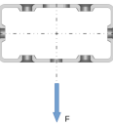
Table D53: Calculation-based deformation in case of fire for installation channels MT-80 S OC and MT-80 OC

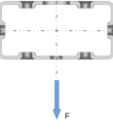
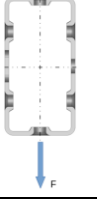
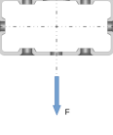
System			Load direction	σ_B	$V^1)$	$F^2)$	$\delta_{t_{max},B}$	$t_{max,B}$	δ_{30}	δ_{60}	δ_{90}	δ_{120}
Loadcase	$L^3)$	n		MPa	-	N	mm	min	mm	mm	mm	mm
1	1700	-		5	0,50	168,95	62,44	120,00	9,66	49,82	58,75	62,44
				10	0,50	376,93	136,59	120,00	17,59	79,31	117,83	136,59
				15	0,50	584,91	269,94	105,00	27,46	115,47	206,03	-
				20	0,50	792,88	260,64	71,67	39,97	170,27	-	-
				25	0,50	1000,86	250,27	55,00	57,92	-	-	-
				30	0,50	1208,83	185,75	40,00	86,70	-	-	-
1	1700	-		5	0,50	76,79	74,67	120,00	13,61	58,99	70,21	74,67
				10	0,50	192,60	163,74	120,00	26,10	98,74	143,60	163,74
				15	0,50	308,41	268,90	120,00	40,58	141,54	221,80	268,90
				20	0,50	424,22	400,99	120,00	58,11	193,51	313,55	400,99
				25	0,50	540,03	552,73	120,00	80,02	254,05	412,05	552,73
				30	0,50	655,85	639,97	120,00	108,54	320,86	535,96	639,97
2	1700	-		5	0,94	718,05	92,79	120,00	13,45	63,16	87,66	92,79
				10	0,94	1601,95	131,09	60,00	26,60	131,09	-	-
				15	0,94	2485,85	76,15	33,33	48,44	-	-	-
				20	0,94	3369,75	35,67	25,00	-	-	-	-
				25	0,94	4253,65	24,91	20,00	-	-	-	-
				30	0,94	5137,55	26,85	18,33	-	-	-	-
2	1700	-		5	0,94	326,35	89,58	120,00	16,82	67,55	84,64	89,58
				10	0,94	818,55	212,46	120,00	34,24	123,48	184,75	212,46
				15	0,94	1310,75	317,02	120,00	57,17	180,56	270,07	317,02
				20	0,94	1802,95	391,17	120,00	85,25	237,59	338,87	391,17
				25	0,94	2295,15	441,73	120,00	118,23	293,09	397,10	441,73
				30	0,94	2787,35	473,10	120,00	154,02	339,46	439,80	473,10
3	1700	15		5	0,67	19,95	73,56	120,00	11,49	55,67	69,72	73,56
				10	0,67	44,50	176,48	120,00	21,36	93,42	147,01	176,48
				15	0,67	69,05	744,33	120,00	34,81	145,87	436,38	744,33
				20	0,67	93,60	802,13	120,00	52,43	282,52	764,75	802,13
				25	0,67	118,16	392,10	46,67	80,08	-	-	-
				30	0,67	142,71	169,01	31,67	130,63	-	-	-
3	1700	15		5	0,67	9,07	85,70	120,00	16,14	65,59	80,89	85,70
				10	0,67	22,74	197,60	120,00	31,68	114,89	171,05	197,60
				15	0,67	36,41	315,56	120,00	50,73	167,78	261,79	315,56
				20	0,67	50,08	433,69	120,00	74,13	230,93	357,41	433,69
				25	0,67	63,75	533,46	120,00	103,95	298,66	445,25	533,46
				30	0,67	77,43	607,61	120,00	142,80	366,38	520,21	607,61

¹⁾ Momentum degree of fullness without contribution from channel dead weight

²⁾ Size of designated system's single load

³⁾ Dimensions in mm and inch



Symbols and designation see Annex D1

Hilti MT installation channels

Bending characteristics of the channel in case of fire

Annex D35

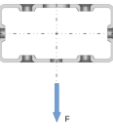
Table D54: Calculation-based deformation in case of fire for installation channels MT-80 S OC and MT-80 OC

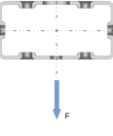
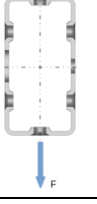
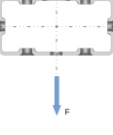
System			Load direction	σ_B	$V^1)$	$F^2)$	$\delta_{t_{max};B}$	$t_{max,B}$	δ_{30}	δ_{60}	δ_{90}	δ_{120}
Loadcase	$L^3)$	n		MPa	-	N	mm	min	mm	mm	mm	mm
1	2100	-		5	0,50	120,16	83,18	120,00	13,57	62,85	79,02	83,18
				10	0,50	288,52	193,72	120,00	25,42	107,14	167,11	193,72
				15	0,50	456,88	432,28	103,33	40,38	160,91	301,21	-
				20	0,50	625,24	454,54	71,67	59,13	242,29	-	-
				25	0,50	793,60	335,47	53,33	85,54	-	-	-
				30	0,50	961,97	271,62	40,00	126,41	-	-	-
1	2100	-		5	0,50	45,55	101,80	120,00	19,93	76,75	96,25	101,80
				10	0,50	139,30	229,82	120,00	38,54	134,63	201,42	229,82
				15	0,50	233,05	368,17	120,00	60,14	195,86	307,61	368,17
				20	0,50	326,80	519,87	120,00	86,18	267,21	421,96	519,87
				25	0,50	420,56	660,20	120,00	118,30	345,93	534,50	660,20
				30	0,50	514,31	785,76	120,00	159,04	428,46	643,89	785,76
2	2100	-		5	0,95	630,82	125,99	120,00	18,61	81,22	119,80	125,99
				10	0,95	1514,72	165,38	56,67	38,79	-	-	-
				15	0,95	2398,62	106,50	31,67	73,38	-	-	-
				20	0,95	3282,52	54,07	25,00	-	-	-	-
				25	0,95	4166,42	35,86	20,00	-	-	-	-
				30	0,95	5050,32	24,72	16,67	-	-	-	-
2	2100	-		5	0,95	239,12	115,35	120,00	22,89	84,53	109,37	115,35
				10	0,95	731,32	284,17	120,00	48,45	163,56	247,68	284,17
				15	0,95	1223,52	421,52	120,00	81,50	242,04	360,67	421,52
				20	0,95	1715,72	515,33	120,00	121,55	315,26	448,60	515,33
				25	0,95	2207,92	577,86	120,00	166,77	386,33	517,77	577,86
				30	0,95	2700,12	617,24	120,00	213,99	444,99	569,82	617,24
3	2100	19		5	0,67	11,47	98,15	120,00	16,00	70,61	93,75	98,15
				10	0,67	27,54	248,72	120,00	30,85	127,22	207,64	248,72
				15	0,67	43,61	783,34	120,00	51,22	204,64	527,36	783,34
				20	0,67	59,68	949,12	120,00	77,86	400,37	857,93	949,12
				25	0,67	75,75	993,65	120,00	119,18	799,47	960,24	993,65
				30	0,67	91,82	258,19	31,67	193,61	-	-	-
3	2100	19		5	0,67	4,35	114,10	120,00	22,88	84,18	108,11	114,10
				10	0,67	13,30	268,38	120,00	45,75	154,39	233,47	268,38
				15	0,67	22,25	417,27	120,00	73,52	227,60	351,66	417,27
				20	0,67	31,19	548,65	120,00	107,21	309,42	465,17	548,65
				25	0,67	40,14	659,76	120,00	148,89	393,45	566,36	659,76
				30	0,67	49,09	741,32	120,00	200,63	473,38	648,91	741,32

¹⁾ Momentum degree of fullness without contribution from channel dead weight

²⁾ Size of designated system's single load

³⁾ Dimensions in mm and inch



Symbols and designation see Annex D1

Hilti MT installation channels

Bending characteristics of the channel in case of fire

Annex D36

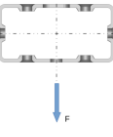
Table D55: Calculation-based deformation in case of fire for installation channels MT-80 S OC and MT-80 OC

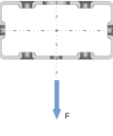
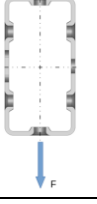
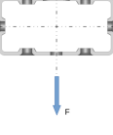
System			Load direction	σ_B	$V^1)$	$F^2)$	$\delta_{t_{max};B}$	$t_{max,B}$	δ_{30}	δ_{60}	δ_{90}	δ_{120}
Loadcase	$L^3)$	n		MPa	-	N	mm	min	mm	mm	mm	mm
1	2500	-		5	0,50	84,04	111,94	120,00	18,91	80,51	107,14	111,94
				10	0,50	225,46	266,28	120,00	35,47	142,67	229,51	266,28
				15	0,50	366,88	802,33	110,00	56,71	217,73	444,31	-
				20	0,50	508,31	773,69	75,00	83,20	335,07	-	-
				25	0,50	649,73	553,35	53,33	120,18	-	-	-
				30	0,50	791,16	357,60	38,33	176,40	-	-	-
1	2500	-		5	0,50	21,36	138,02	120,00	28,38	100,04	130,94	138,02
				10	0,50	100,12	308,53	120,00	54,19	178,52	270,72	308,53
				15	0,50	178,87	479,18	120,00	84,29	260,12	405,06	479,18
				20	0,50	257,62	648,90	120,00	120,30	351,28	540,54	648,90
				25	0,50	336,37	799,48	120,00	164,15	447,94	668,01	799,48
				30	0,50	415,12	920,41	120,00	218,40	545,27	783,93	920,41
2	2500	-		5	0,96	525,22	167,24	120,00	25,23	104,23	159,69	167,24
				10	0,96	1409,12	232,67	56,67	54,14	-	-	-
				15	0,96	2293,02	104,86	30,00	104,86	-	-	-
				20	0,96	3176,92	74,04	25,00	-	-	-	-
				25	0,96	4060,82	49,16	20,00	-	-	-	-
				30	0,96	4944,72	33,95	16,67	-	-	-	-
2	2500	-		5	0,96	133,52	145,36	120,00	30,03	104,44	138,15	145,36
				10	0,96	625,72	364,93	120,00	64,95	208,49	318,19	364,93
				15	0,96	1117,92	537,66	120,00	109,40	310,87	461,33	537,66
				20	0,96	1610,12	651,27	120,00	163,48	401,99	569,29	651,27
				25	0,96	2102,32	724,49	120,00	222,40	489,01	648,80	724,49
				30	0,96	2594,52	770,14	120,00	282,41	560,63	708,64	770,14
3	2500	23		5	0,67	6,73	129,65	120,00	21,75	89,60	124,51	129,65
				10	0,67	18,07	334,26	120,00	42,67	168,76	280,38	334,26
				15	0,67	29,40	832,28	120,00	71,46	275,19	466,73	832,28
				20	0,67	40,73	1062,42	120,00	109,03	529,85	903,31	1062,42
				25	0,67	52,06	1146,38	120,00	166,63	807,77	1085,21	1146,38
				30	0,67	63,39	1202,27	120,00	271,92	1102,39	1176,33	1202,27
3	2500	23		5	0,67	1,71	149,31	120,00	31,32	107,01	141,74	149,31
				10	0,67	8,02	348,26	120,00	62,61	200,36	304,42	348,26
				15	0,67	14,33	527,60	120,00	100,39	295,27	450,39	527,60
				20	0,67	20,64	672,83	120,00	145,71	395,98	581,12	672,83
				25	0,67	26,95	792,97	120,00	200,13	496,13	694,65	792,97
				30	0,67	33,26	881,96	120,00	265,20	587,86	785,50	881,96

¹⁾ Momentum degree of fullness without contribution from channel dead weight

²⁾ Size of designated system's single load

³⁾ Dimensions in mm and inch

Symbols and designation see Annex D1

Hilti MT installation channels

Bending characteristics of the channel in case of fire

Annex D37

Figure E1: Example use case Hilti MT installation channel used as headrail

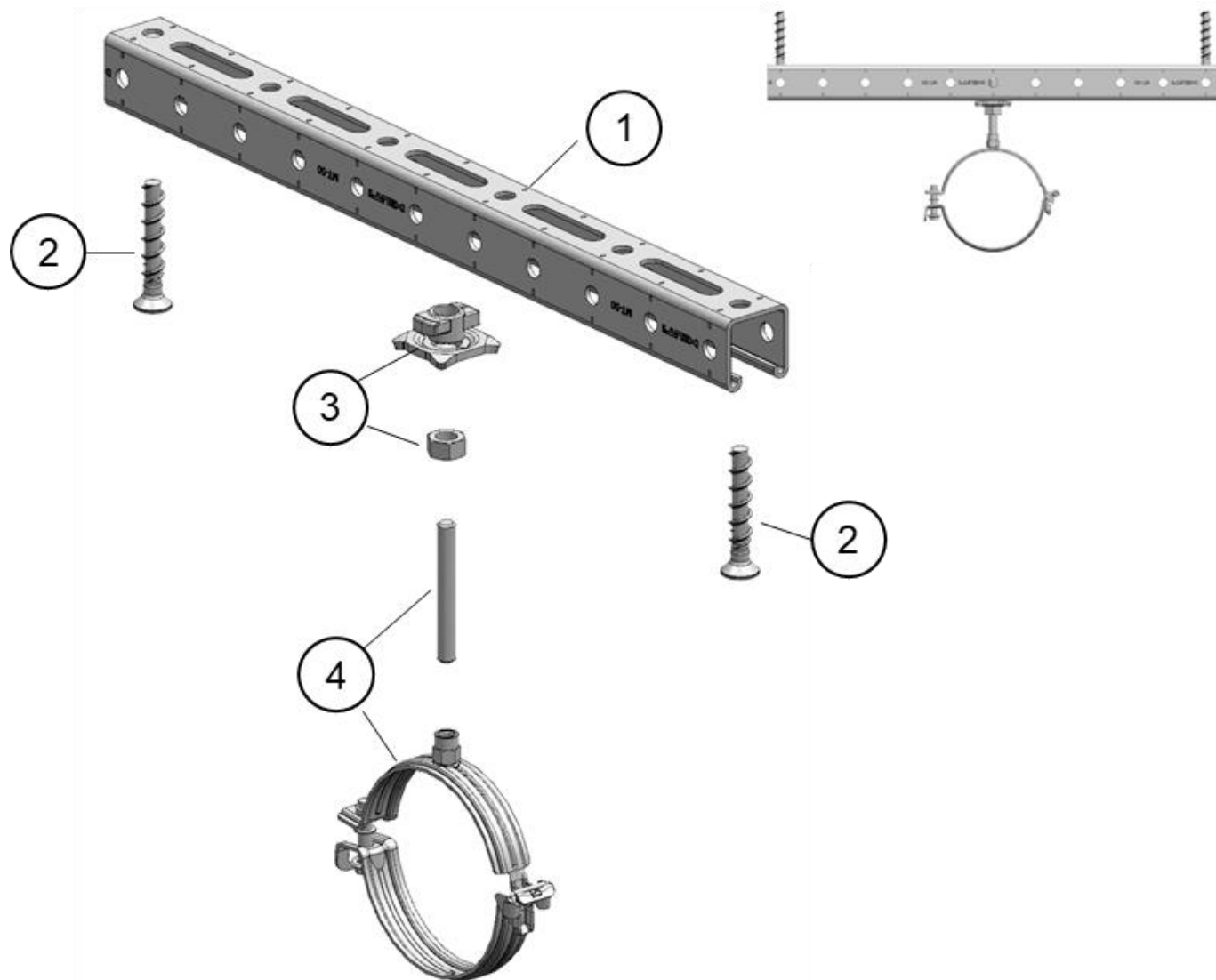

Legend

- 1 MT-30, MT-40, MT-40D or MT-50
- 2 Fastener to the substructure
- 3 MQA-B with hexagonal nut
- 4 Pipe ring with threaded rod

Annex

- A1
- Not an integral part of this ETA
- Not an integral part of this ETA
- Not an integral part of this ETA

Hilti MT installation channels

Example usage: Hilti MT installation channel used as headrail

Annex E1
 (informative)

Figure E2: Example use case Hilti MT installation channel used as rod trapeze

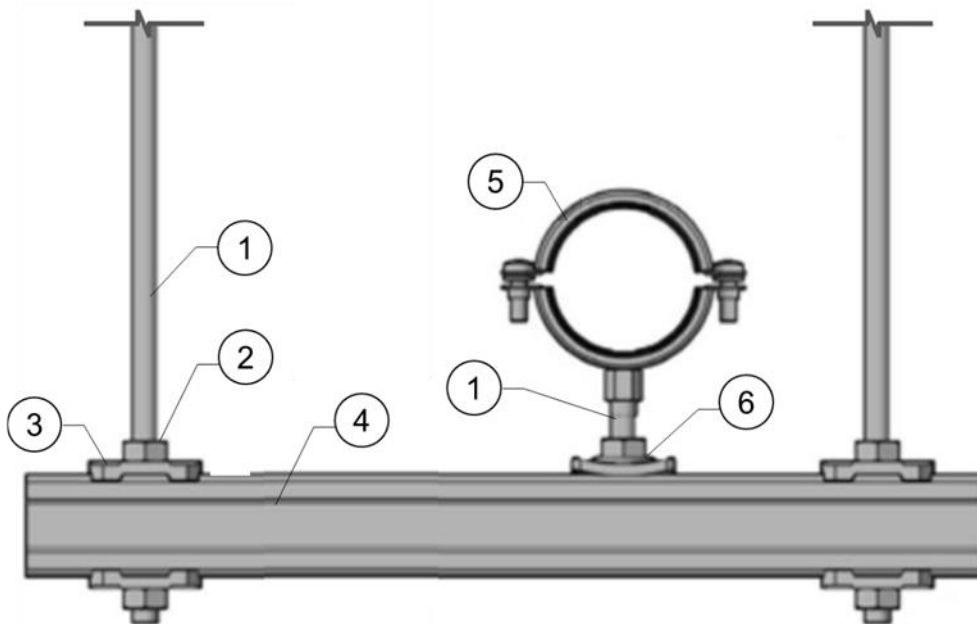

Legend

- 1 Threaded rod
- 2 Hexagonal nut
- 3 MQZ-L drilled plates
- 4 MT-30, MT-40, MT-40D or MT-50
- 5 Pipe ring
- 6 MQA-B saddle nut

Annex

- Not an integral part of this ETA
- Not an integral part of this ETA
- Not an integral part of this ETA
- Annex A
- Not an integral part of this ETA
- Not an integral part of this ETA

Hilti MT installation channels

Example usage: Hilti MT installation channel used as rod-trapeze

Annex E2
 (informative)



European Technical Assessment

ETA-23/0106 of 30/08/2023

English translation prepared by CSTB - Original version in French language

General Part

Technical Assessment Body issuing the European Technical Assessment:

Centre Scientifique et Technique du Bâtiment (CSTB)

Trade name of the construction product: Hilti cantilevers of MT System

Product family to which the construction product belongs: Products for installation systems for supporting technical building equipment

Manufacturer: Hilti AG Liechtenstein
Feldkircherstraße 100
9494 Schaan
FÜRSTENTUM LIECHTENSTEIN

Manufacturing plants: L 1027881 and L1087643

This European Technical Assessment contains: 34 pages including 31 pages of annexes which form an integral part of this assessment

This European Technical Assessment is issued in accordance with Regulation (EU) No 305/2011, on the basis of: European Assessment Document (EAD)
280016-00-0602 version June 2020

This Assessment replaces: -

The European Technical Assessment is issued by the Technical Assessment Body in its official language. Translations of this European Technical Assessment in other languages shall fully correspond to the original issued document and shall be identified as such. Communication of this European Technical Assessment, including transmission by electronic means, shall be in full. However, partial reproduction may only be made with the written consent of the issuing Technical Assessment Body. Any partial reproduction shall be identified as such. This European Technical Assessment may be withdrawn by the issuing Technical Assessment Body, in particular pursuant to information by the Commission in accordance with Article 25(3) of Regulation (EU) No 305/2011.

Specific Part

1 Technical description of the product

This European Technical Assessment covers HILTI cantilevers of MT System: MT-BR-30 300, MT-BR-30 300 OC, MT-BR-30 450, MT-BR-30 450 OC, MT-BR-40 300, MT-BR-40 300 OC, MT-BR-40 450, MT-BR-40 450 OC, MT-BR-40 600, MT-BR-40 600 OC, MT-BR-40 1000, MT-BR-40 1000 OC, MT-BR-40D 600, MT-BR-40D 600 OC, MT-BR-40D 1000, MT-BR-40D 1000 OC, MT-BR-40 O4 600 OC, MT-BR-40 O4 1000 OC, MT-BR-40D O4 600 OC, MT-BR-40D O4 1000 OC and MT-BR-40D O4 1500 OC.

The HILTI cantilevers MT-BR-30 300, MT-BR-30 300 OC, MT-BR-30 450 and MT-BR-30 450 OC are made of steel installation channels with open profile, with two arms of different length perpendicular to each other.

The HILTI cantilevers MT-BR-40 300, MT-BR-40 300 OC, MT-BR-40 450, MT-BR-40 450 OC, MT-BR-40 600, MT-BR-40 600 OC, MT-BR-40 1000, MT-BR-40 1000 OC, MT-BR-40D 600, MT-BR-40D 600 OC, MT-BR-40D 1000, MT-BR-40D 1000 OC, MT-BR-40 O4 600 OC, MT-BR-40 O4 1000 OC, MT-BR-40D O4 600 OC, MT-BR-40D O4 1000 OC and MT-BR-40D O4 1500 OC consist of a steel baseplate with elongated holes and welded-on, steel installation channels with open profile.

Above mentioned cantilevers can also be used with additional suspension. In this case the cantilevers of MT System are combined with Hilti MQZ-L drilled plates.

Annex A describes the dimensions and materials of above-mentioned Hilti cantilevers of MT System and accessories.

2 Specification of the intended use

The performance given in Section 3 can only be assumed if the Hilti cantilevers of MT System are used in compliance with the specifications and under boundary conditions set out in Annexes A to D. The test and assessment methods on which this European Technical Assessment is based lead to an assumption of a working life of the Hilti cantilevers of MT System of at least 50 years in final use under ambient temperatures in indoor areas. The indications given on the working life cannot be interpreted as a guarantee given by the producer, but are to be regarded only as a means for choosing the right products in relation to the expected economically reasonable working life of the works.

In accordance with the European Assessment Document EAD 280016-00-0602, the product is intended to be used in

- a) installations for the support of sprinkler kits,
- b) installations for the support of pipes for the transport of gas/fuel intended for the supply of building heating/cooling systems.

3 Performance of the product and references to the methods used for its assessment

3.1 Safety in case of fire (BWR 2)

No.	Essential characteristic	Performance
1	Reaction to fire	Class A1
2	Resistance under fire exposure	See Annex C and D

3.2 Safety and accessibility in use (BWR 4)

No.	Essential characteristic	Performance
3	Shape	See Annex A
4	Dimension	See Annex A
5	Material	See Annex A
6	Characteristic resistance	See Annex C

4 Assessment and verification of constancy of performance (AVCP) system applied, with reference to its legal base

In accordance with the European Assessment Document EAD 280016-00-0602, the following legal bases apply:

- In case of intended use a) specified in Section 2:
Decision of the commission N° 1996/577/EC as amended by Commission Decision 2002/592/EC.:
System 1 applies for the assessment and verification of constancy of performance (AVCP).
- In case of intended use b) specified in Section 2:
Decision of the commission N° 1999/472/EC as amended by Commission Decision 2001/596/EC:
System 3 applies for the assessment and verification of constancy of performance (AVCP).

5 Technical details necessary for the implementation of the AVCP system, as provided for in the applicable EAD

The technical details necessary for the implementation of the system for the assessment and verification of constancy of performance are laid down in the control plan (confidential part of this European Technical Assessment) deposited at Centre Scientifique et Technique du Bâtiment.

The original French version is signed by

La cheffe de division, Anca CRONOPOL

Table A1: Shape, dimensions and materials of the cantilevers MT-BR-30 300, MT-BR-30 300 OC, MT-BR-30 450, MT-BR-30 450 OC, MT-BR-40 300, MT-BR-40 300 OC, MT-BR-40 450, MT-BR-40 450 OC, MT-BR-40 600, MT-BR-40 600 OC, MT-BR-40 1000, MT-BR-40 1000 OC

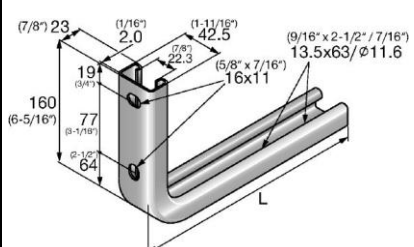
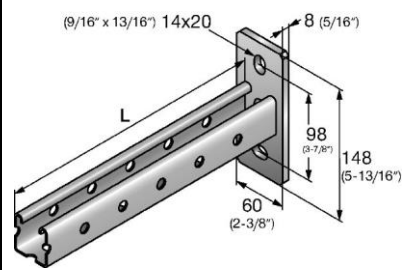
Item number	Designation	L in mm	Materials	Illustration (Dimensions in mm and inch)
2271288	MT-BR-30 300	300	Steel Q235B acc. to GB/T 700, galvanized ¹⁾	
2271440	MT-BR-30 450	450		
2271289	BR-BR-30 300 OC	300	Steel Q235B acc. to GB/T 700, hot dip galvanized ²⁾	
2271441	MT-BR-30 450 OC	450		
2271442	MT-BR-40 300	300	Steel Q235B acc. to GB/T 700, galvanized ¹⁾	
2271444	MT-BR-40 450	450		
2271451	MT-BR-40 600	600		
2271446	MT-BR-40 1000	1000		
2271443	MT-BR-40 300 OC	300	Steel Q235B acc. to GB/T 700, hot dip galvanized ²⁾	
2271445	MT-BR-40 450 OC	450		
2271449	MT-BR-40 600 OC	600		
2271447	MT-BR-40 1000 OC	1000		

¹⁾ Alternative: S235JR or S280GD (or HN704) + Z275-M-A-C acc. to EN 10346

²⁾ Alternative: S235JR or S280GD (or HN704) + ZM310-A-C acc. to EN 10346

Hilti cantilevers MT-BR-30, MT-BR-40 and MT-BR-40 D with load introduction component with and without additional suspension

Product Description
 Dimensions and materials

Annex A1

Table A2: Shape, dimensions and materials of the cantilevers MT-BR-40 D 600, MT-BR-40 D 1000, MT-BR-40 600 OC, MT-BR-40 1000 OC, MT-BR-40 O4 600 OC, MT-BR-40 O4 1000 OC, MT-BR-40 D O4 600 OC, MT-BR-40 D O4 1000 OC

Item number	Designation	L in mm	Materials	Illustration (Dimensions in mm and inch)	
2271448	MT-BR-40D 600	600	Steel Q235B acc. to GB/T 700, galvanized ¹⁾		
2271450	MT-BR-40D 1000	1000			
2271449	MT-BR-40D 600 OC	600	Steel Q235B acc. to GB/T 700, hot dip galvanized ²⁾		
2271453	MT-BR-40D 1000 OC	1000			
2271455	MT-BR-40 O4 600 OC	600	Steel Q235B acc. to GB/T 700, hot dip galvanized ¹⁾		
2271456	MT-BR-40 O4 1000 OC	1000			
2271459	MT-BR-40D O4 600 OC	600	Steel Q235B acc. to GB/T 700, hot dip galvanized ²⁾		
2271461	MT-BR-40D O4 1000 OC	1000			
2271287	MT-BR-40D O4 1000 OC	1500			

¹⁾ Alternative: S235JR or S280GD (or HN704) + Z275-M-A-C acc. to EN 10346

²⁾ Alternative: S235JR or S280GD (or HN704) + ZM310-A-C acc. to EN 10346

Hilti cantilevers MT-BR-30, MT-BR-40 and MT-BR-40 D with load introduction component with and without additional suspension

Product Description
 Dimensions and materials

Annex A2

Table A3: Hilti cantilevers and associated Hilti installation channels

Hilti Cantilever	Hilti installation channel
MT-BR-30 300 MT-BR-30 450	MT-30
MT-BR-30 300 OC MT-BR-30 450 OC	MT-30 OC
MT-BR-40 300 MT-BR-40 450 MT-BR-40 600 MT-BR-40 1000	MT-40
MT-BR-40 300 OC MT-BR-40 450 OC MT-BR-40 600 OC MT-BR-40 1000 OC MT-BR-40 O4 600 OC MT-BR-40 O4 1000 OC	MT-40 OC
MT-BR-40D 600 MT-BR-40D 1000	MT-40 D
MT-BR-40D 600 OC MT-BR-40D 1000 OC MT-BR-40D O4 600 OC MT-BR-40D O4 1000 OC MT-BR-40D O4 1500 OC	MT-40 D OC

Hilti cantilevers MT-BR-30, MT-BR-40 and MT-BR-40 D with load introduction component with and without additional suspension

Product Description
 Dimensions and materials

Annex A3

Figure A1: Suspended Hilti MT System cantilevers with load introduction components

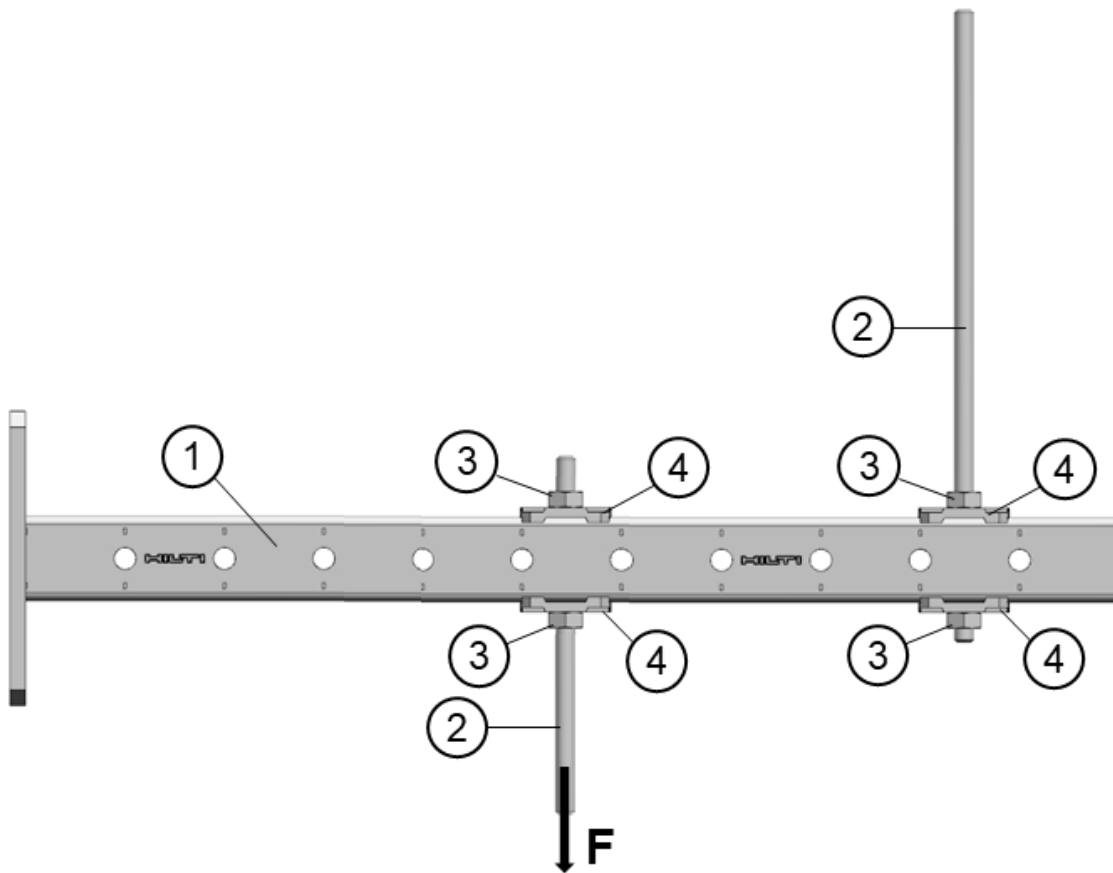

Legend

- 1 MT-BR-30, MT-BR-40 or MT-BR-40D
- 2 Threaded rod M10 or M12
- 3 Hexagonal nut M10 or M12
- 4 MQZ-L11 or MQZ-L13 drilled plates
- F Applied load

Annex

- Annex B to D
- Annex B4
- Annex B5
- Annex B5

Hilti cantilevers MT-BR-30, MT-BR-40 and MT-BR-40 D with load introduction component with additional suspension

Description of products for intended use

Annex A4

Figure A2: Hilti MT System cantilevers with load introduction components

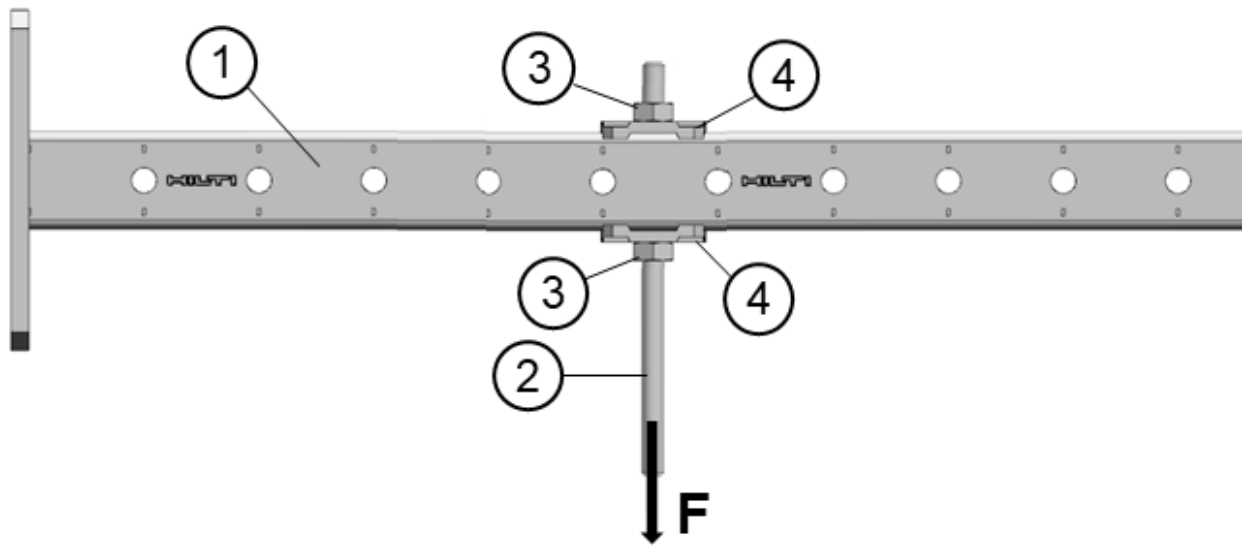

Legend

- 1 MT-BR-30, MT-BR-40 or MT-BR-40D
- 2 Threaded rod M10 or M12
- 3 Hexagonal nut M10 or M12
- 4 MQZ-L11 or MQZ-L13 drilled plates
- F Applied load

Annex

- Annex B to D
- Annex B4
- Annex B5
- Annex B5

Hilti cantilevers MT-BR-30, MT-BR-40 and MT-BR-40 D with load introduction component without additional suspension

Description of products for intended use

Annex A5

Specification of intended use

- Hilti cantilevers of MT System with load introduction component are used to transfer building services component loads such as ducts and equipment for sprinklers, water, heating, cooling, ventilation, electrical and other systems at ambient temperature and in case of fire. The Hilti cantilevers of MT System can also be used with additional suspension when combined with MQZ-L drilled plate.
- Hilti cantilevers of MT System are performing this loadbearing function under the conditions described in Section 2 of this European Technical Assessment.
- The resistance and deformation at in case of fire are referring to the boundary conditions of the standard temperature / time curve (STTC) in accordance with EN 1363-1.
- The resistance of suspended cantilevers of MT System in case of fire applies for static and centric actions on the threaded rod M10 or M12 according to Annex D.
- The resistance of HILTI cantilevers set down in Annex C1 applies for static actions in the direction of the main axes X, Y, Z.
- For cantilevers MT-BR-30 300, MT-BR-30 300 OC, MT-BR-30 450 and MT-BR-30 450 OC the point of intersection of the axes X, Y, Z is located in the centroid position of the cross section of the installation channel acc. to Figure B1.

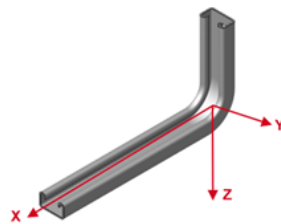

Figure B1: Coordinate system of the resistances of MT-BR-30 300, MT-BR-30 300 OC, MT-BR-30 450 and MT-BR-30 450 OC

- For cantilevers MT-BR-40 300, MT-BR-40 300 OC, MT-BR-40 450, MT-BR-40 450 OC, MT-BR-40 600, MT-BR-40 600 OC, MT-BR-40 1000, MT-BR-40 1000 OC, MT-BR-40D 600, MT-BR-40D 600 OC, MT-BR-40D 1000, MT-BR-40D 1000 OC, MT-BR-40 O4 600 OC, MT-BR-40 O4 1000 OC, MT-BR-40D O4 600 OC, MT-BR-40D O4 1000 OC and MT-BR-40D O4 1500 OC the point of intersection of the axes X, Y, Z is located in the centroid position of the cross section of the installation channel and on the baseplate surface facing the channel acc. to Figure B2.

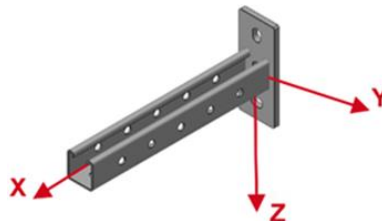

Figure B2: Coordinate system of the resistances of MT-BR-40 300, MT-BR-40 300 OC, MT-BR-40 450, MT-BR-40 450 OC, MT-BR-40 600, MT-BR-40 600 OC, MT-BR-40 1000, MT-BR-40 1000 OC, MT-BR-40D 600, MT-BR-40D 600 OC, MT-BR-40D 1000, MT-BR-40D 1000 OC, MT-BR-40 O4 600 OC, MT-BR-40 O4 1000 OC, MT-BR-40D O4 600 OC, MT-BR-40D O4 1000 OC and MT-BR-40D O4 1500 OC

- The welded connections of the installation channel profiles to the base plates are presented in the Figures B3 to B6.
- The resistance of the welded connection in case of fire are presented in Annex C2 and Annex C3.

<p>Hilti cantilevers MT-BR-30, MT-BR-40 and MT-BR-40 D with load introduction component with and without additional suspension</p>	<p>Annex B9</p>
<p>Requirements for performance assessment</p>	

- Prior to installation, it has to be ensured that the component to be supported by the cantilevers, the anchoring of the cantilever to the base material and the base material itself are suitable to withstand the resistance values given in Annex C and Annex D in this European Technical Assessment at ambient temperature and in case of fire.
- The cantilevers must be installed by appropriately qualified personnel and under the supervision of the site manager. The general installation instructions of the manufacturer apply.

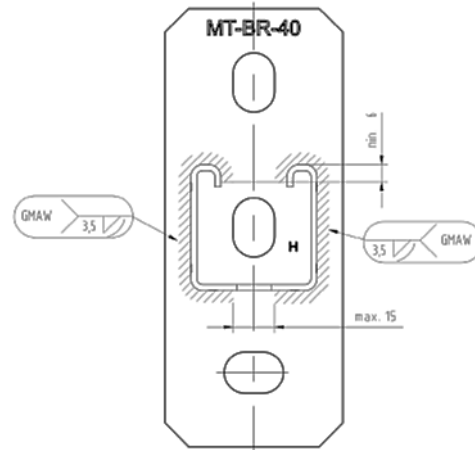

Figure B3: Welded connection of HILTI cantilevers MT-BR-40 300, MT-BR-40 300 OC, MT-BR-40 450, MT-BR-40 450 OC, MT-BR-40 600, MT-BR-40 600 OC, MT-BR-40 1000 and MT-BR-40 1000 OC

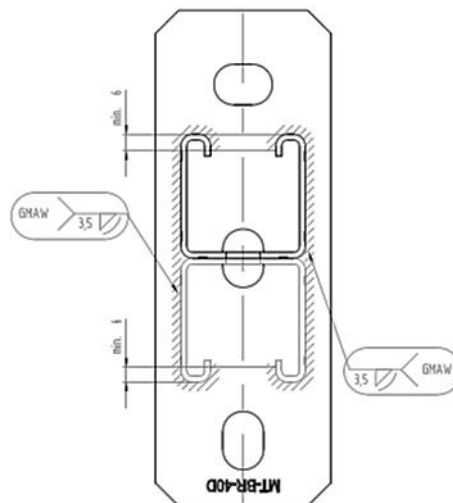

Figure B4: Welded connection of Hilti cantilevers MT-BR-40D 600, MT-BR-40D 600 OC, MT-BR-40D 1000 and MT-BR-40D 1000 OC

Hilti cantilevers MT-BR-30, MT-BR-40 and MT-BR-40 D with load introduction component with and without additional suspension

Requirements for performance assessment

Annex B10

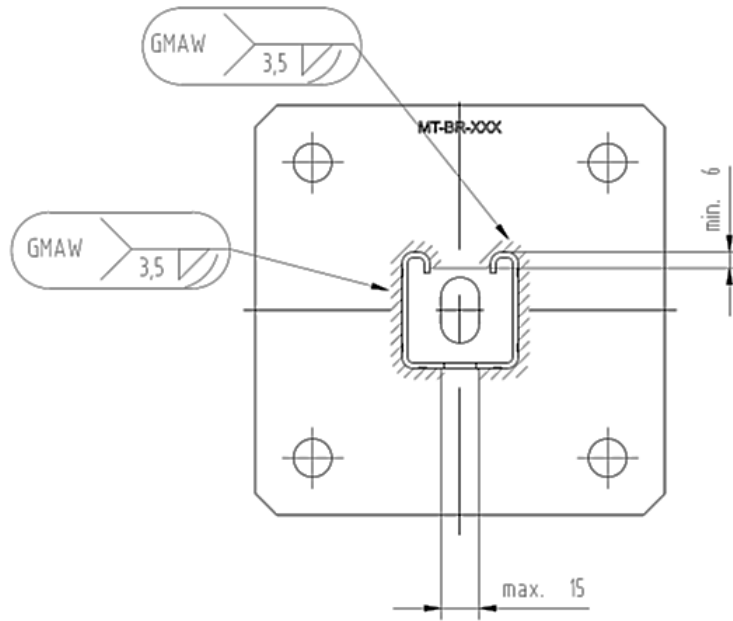

Figure B5: Welded connection types of Hilti cantilevers MT-BR-40 O4 600 OC and MT-BR-40 O4 1000 OC

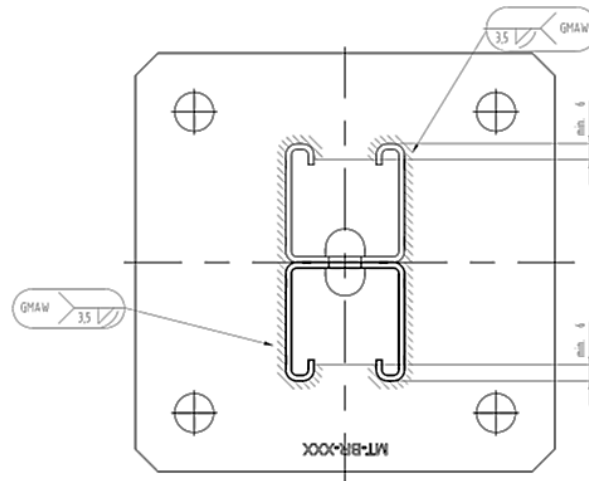



Figure B6: Welded connection types of Hilti cantilevers MT-BR-40D O4 600 OC, MT-BR-40D O4 1000 OC and MT-BR-40D O4 1500 OC

Hilti cantilevers MT-BR-30, MT-BR-40 and MT-BR-40 D with load introduction component with and without additional suspension

Requirements for performance assessment

Annex B11

Table B12: Dimensions and materials of Hilti threaded rods for use with Hilti cantilevers of MT System

Item number	Designation	M thread	L [mm]	Materials	Illustration
339795	AM10x1000 4.8	M10	1000	Strength class 4.8 in accordance with DIN976-1, zinc coated	
339796	AM10x2000 4.8	M10	2000		
216418	AM10x3000 4.8	M10	3000		
339797	AM12x1000 4.8	M12	1000		
216420	AM12x2000 4.8	M12	2000		
216421	AM12x3000 4.8	M12	3000		
407497	AM 8.8 M10x1000	M10	1000	Strength class 8.8 in accordance with DIN976-1, zinc coated	
2008566	AM 8.8 M10x3000	M10	3000		
407498	AM 8.8 M12x1000	M12	1000		
2008567	AM 8.8 M12x3000	M12	3000		
58670	AM10x1000 A4-70	M10	1000	Strength class A4-70 in accordance with DIN976-1, Stainless steel	
58707	AM10x3000 A4-70	M10	3000		
58671	AM12x1000 A4-70	M12	1000		
58709	AM12x3000 A4-70	M12	3000		

Hilti cantilevers MT-BR-30, MT-BR-40 and MT-BR-40 D with load introduction component with and without additional suspension

Requirements for performance assessment

Annex B12

Table B13: Dimensions and materials of Hilti hexagonal nuts for use with Hilti cantilevers of MT System

Illustration	Item number	Designation	M thread	W [mm]	H [mm]	Material
	216466	M10 hexagonal nut	M10	17	8	Strength class 8 in accordance with DIN 934, zinc coated
	2184554	M12 hexagonal nut	M12	19	10	
	2184474	M10 hexagonal nut	M10	17	8	Strength class 70 in accordance with DIN 934, stainless steel
	2184475	M12 hexagonal nut	M12	19	10	

Table B3: Geometry and dimensions of MQZ-L11 and MQZ-L13 drilled plates for use with Hilti cantilevers of MT System

Item number	Designation	D [mm]	Materials	Illustration
2199455	MQZ-L11	11,5	S235JR in accordance with DIN EN 10025-2	
2199456	MQZ-L13	13,5		

Hilti cantilevers MT-BR-30, MT-BR-40 and MT-BR-40 D with load introduction component with and without additional suspension

Requirements for performance assessment

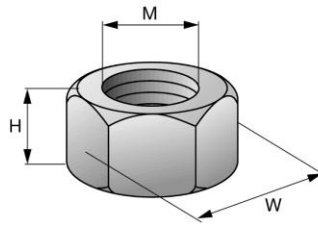
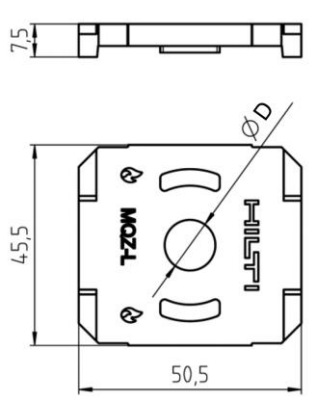
Annex B13

Table C1: Characteristic resistance of the cantilevers MT-BR-30 300, MT-BR-30 300 OC, MT-BR-30 450 and MT-BR-30 450 OC acc. to the coordinate system in figure B1

+F _{x,Rk} [kN]	-F _{x,Rk} [kN]	+F _{y,Rk} [kN]	-F _{y,Rk} [kN]	+F _{z,Rk} [kN]	-F _{z,Rk} [kN]
NPA	NPA	NPA	NPA	1,775	1,65
+M _{x,Rk} [kNm]	-M _{x,Rk} [kNm]	+M _{y,Rk} [kNm]	-M _{y,Rk} [kNm]	+M _{z,Rk} [kNm]	-M _{z,Rk} [kNm]
NPA	NPA	0,239	0,239	NPA	NPA

Table C2: Characteristic resistance of the cantilevers MT-BR-40 300, MT-BR-40 300 OC, MT-BR-40 450, MT-BR-40 450 OC, MT-BR-40 600, MT-BR-40 600 OC, MT-BR-40 1000, MT-BR-40 1000 OC acc. to the coordinate system in figure B2 (including resistance of welded connection)

+F _{x,Rk} [kN]	-F _{x,Rk} [kN]	+F _{y,Rk} [kN]	-F _{y,Rk} [kN]	+F _{z,Rk} [kN]	-F _{z,Rk} [kN]
NPA	NPA	NPA	NPA	9,48	10,66
+M _{x,Rk} [kNm]	-M _{x,Rk} [kNm]	+M _{y,Rk} [kNm]	-M _{y,Rk} [kNm]	+M _{z,Rk} [kNm]	-M _{z,Rk} [kNm]
NPA	NPA	1,006	1,006	NPA	NPA

Table C3: Characteristic resistance of the cantilevers MT-BR-40D 600, MT-BR-40D 600 OC, MT-BR-40D 1000, MT-BR-40D 1000 OC acc. to the coordinate system in figure B2 (including resistance of welded connection)

+F _{x,Rk} [kN]	-F _{x,Rk} [kN]	+F _{y,Rk} [kN]	-F _{y,Rk} [kN]	+F _{z,Rk} [kN]	-F _{z,Rk} [kN]
NPA	NPA	NPA	NPA	17,17	17,17
+M _{x,Rk} [kNm]	-M _{x,Rk} [kNm]	+M _{y,Rk} [kNm]	-M _{y,Rk} [kNm]	+M _{z,Rk} [kNm]	-M _{z,Rk} [kNm]
NPA	NPA	2,25	2,25	NPA	NPA

Table C4: Characteristic resistance of the cantilevers MT-BR-40 O4 600 OC, MT-BR-40 O4 1000 OC, acc. to the coordinate system in figure B1,2 (including resistance of welded connection)

+F _{x,Rk} [kN]	-F _{x,Rk} [kN]	+F _{y,Rk} [kN]	-F _{y,Rk} [kN]	+F _{z,Rk} [kN]	-F _{z,Rk} [kN]
NPA	NPA	NPA	NPA	9,91	9,97
+M _{x,Rk} [kNm]	-M _{x,Rk} [kNm]	+M _{y,Rk} [kNm]	-M _{y,Rk} [kNm]	+M _{z,Rk} [kNm]	-M _{z,Rk} [kNm]
NPA	NPA	0,489	0,489	NPA	NPA

Table C5: Characteristic resistance of the cantilevers MT-BR-40D O4 600 OC, MT-BR-40D O4 1000 OC, MT-BR-40D O4 1500 OC according to the coordinate system in figure B2 (including resistance of welded connection)

+F _{x,Rk} [kN]	-F _{x,Rk} [kN]	+F _{y,Rk} [kN]	-F _{y,Rk} [kN]	+F _{z,Rk} [kN]	-F _{z,Rk} [kN]
NPA	NPA	NPA	NPA	20,29	20,29
+M _{x,Rk} [kNm]	-M _{x,Rk} [kNm]	+M _{y,Rk} [kNm]	-M _{y,Rk} [kNm]	+M _{z,Rk} [kNm]	-M _{z,Rk} [kNm]
NPA	NPA	2,253	2,253	NPA	NPA

Characteristic resistances for ambient temperatures do not consider deflections.

Partial safety factor for design resistance is $\gamma_M = F_{Rk} / F_{Rd}$ or $\gamma_M = M_{Rk} / M_{Rd}$. Design resistances from the manufacturer's specifications and national regulations must be observed.

In case of more than one force acting simultaneous on the cantilever, the interaction formula given in appropriate Eurocode can be used for the design of the cantilevers.

Hilti cantilevers MT-BR-30, MT-BR-40 and MT-BR-40 D with load introduction component with and without additional suspension

Characteristic resistance of Hilti cantilevers at ambient temperature

Annex C1

Table C6: Resistance of MT-BR-40 weld in case of fire: Parameter of regression curve
 $\sigma_{Rk,t} = c_3 (c_1 + c_2 / t)$ of Hilti MT-BR-40 cantilevers

Designation	C ₁	C ₂	C ₃	t _{min} [min]	t _{max} [min]
MT-BR-40 300	31,5988	1780,0922	0,718372	16	144
MT-BR-40 450					
MT-BR-40 600					
MT-BR-40 1000					
MT-BR-40 300 OC					
MT-BR-40 450 OC					
MT-BR-40 600 OC					
MT-BR-40 1000 OC					
MT-BR-40 O4 600 OC					
MT-BR-40 O4 1000 OC					

Table C7: Resistance of MT-BR-40 weld in case of fire after t = 30, 60, 90 and 120 minutes

Designation	$\sigma_{Rk,30}$ [N/mm ²]	$\sigma_{Rk,60}$ [N/mm ²]	$\sigma_{Rk,90}$ [N/mm ²]	$\sigma_{Rk,120}$ [N/mm ²]
MT-BR-40 300	65,3	44,0	36,9	33,4
MT-BR-40 450				
MT-BR-40 600				
MT-BR-40 1000				
MT-BR-40 300 OC				
MT-BR-40 450 OC				
MT-BR-40 600 OC				
MT-BR-40 1000 OC				
MT-BR-40 O4 600 OC				
MT-BR-40 O4 1000 OC				

Hilti cantilevers MT-BR-30, MT-BR-40 and MT-BR-40 D with load introduction component with and without additional suspension

Resistance of Hilti MT-BR-40 to baseplate welding in case of fire

Annex C2

Table C8: Resistance of MT-BR-40D weld in case of fire: Parameter of regression curve
 $\sigma_{Rk,t} = c_3 (c_1 + c_2 / t)$ of Hilti MT-BR-40D cantilevers

Designation	C ₁	C ₂	C ₃	t _{min} [min]	t _{max} [min]
MT-BR-40D 600 MT-BR-40D 1000 MT-BR-40D 600 OC MT-BR-40D 1000 OC MT-BR-40D O4 600 OC MT-BR-40D O4 1000 OC MT-BR-40D O4 1500 OC	10,0446	1902,3367	0,854055	24	150

Table C9: Resistance of MT-BR-40D weld in case of fire after t = 30, 60, 90 and 120 minutes

Designation	$\sigma_{Rk,30}$ [N/mm ²]	$\sigma_{Rk,60}$ [N/mm ²]	$\sigma_{Rk,90}$ [N/mm ²]	$\sigma_{Rk,120}$ [N/mm ²]
MT-BR-40D 600 MT-BR-40D 1000 MT-BR-40D 600 OC MT-BR-40D 1000 OC MT-BR-40D O4 600 OC MT-BR-40D O4 1000 OC MT-BR-40D O4 1500 OC	62,7	35,7	26,6	22,1

Hilti cantilevers MT-BR-30, MT-BR-40 and MT-BR-40 D with load introduction component with and without additional suspension

Resistance of Hilti MT-BR-40D to baseplate welding in case of fire

Annex C3

Table C10: Resistance to combined bending and tension load in case of fire: Parameter of regression curve $F_{Rk,t} = c_3 (c_1 + c_2 / t)$ of Hilti threaded rods

Designation	c_1	c_2	c_3	t_{min} [min]	t_{max} [min]
AM10 x L ¹⁾ 4.8	260,907	29615,482	0,927769	30	146
AM12 x L ¹⁾ 4.8	NPA ²⁾	NPA	NPA	NPA	NPA
AM 8.8 M10 x L ¹⁾	56,4981	62518,204	0,930393	45	130
AM 8.8 M12 x L ¹⁾	-315,1713	117316,0732	0,851412	42	130
AM10 A4-70 x L ¹⁾	-1321,3377	432114,1576	0,617514	43	120
AM12 A4-70 x L ¹⁾	-763,2431	538678,9931	0,887458	55	130

Table C11: Resistance $F_{Rk,t}$ to combined bending and tension load in case of fire after $t = 30, 60, 90$ and 120 minutes of Hilti threaded rods

Designation	$F_{Rk,30}$ [N]	$F_{Rk,60}$ [N]	$F_{Rk,90}$ [N]	$F_{Rk,120}$ [N]
AM10 x L ¹⁾ 4.8	1158	700	547	471
AM12 x L ¹⁾ 4.8	NPA ²⁾	NPA	NPA	NPA
AM 8.8 M10 x L ¹⁾	1991,4	1022,0	698,9	537,3
AM 8.8 M12 x L ¹⁾	3061,1	1396,4	841,5	564,0
AM10 A4-70 x L ¹⁾	8078,6	3631,3	2148,9	1407,7
AM12 A4-70 x L ¹⁾	7290,2	7290,2	4634,4	3306,4

1) Cantilever arm length of threaded rod ≤ 150 mm





L Length of threaded rod: 1000 mm, 2000 mm or 3000 mm

Hilti threaded rods M10 and M12 for use with MT-BR-30, MT-BR-40 and MT-BR-40 D as load introduction component or suspension

Characteristic resistance of Hilti threaded rods in case of fire

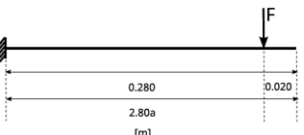
Annex C4

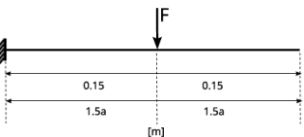
Table D18: Calculation-based deformation in case of fire for Hilti MT-BR-30 300 and MT-BR-30 300 OC cantilevers without suspension

System	Load direction	σ_B	$V^{1)}$	$F^{2)}$	$\delta_{t_{max};B}$	$t_{max,B}$	δ_{30}	δ_{60}	δ_{90}	δ_{120}
		MPa	-	N	mm	min	mm	mm	mm	mm
		5	0,50	15,91	48,09	120,00	9,75	26,30	31,98	48,09
		10	0,50	34,07	95,46	120,00	18,84	44,31	63,05	95,46
		15	0,50	52,22	145,11	120,00	28,47	63,82	98,14	145,11
		20	0,50	70,38	181,56	120,00	39,57	86,80	131,95	181,56
		25	0,50	88,53	205,38	120,00	52,78	112,23	160,50	205,38
		30	0,50	106,69	221,36	120,00	68,25	136,37	182,31	221,36
		5	0,50	15,91	49,56	120,00	9,85	26,67	32,81	49,56
		10	0,50	34,07	110,50	120,00	19,34	46,01	68,53	110,50
		15	0,50	52,22	185,73	120,00	29,71	68,87	116,11	185,73
		20	0,50	70,38	236,59	120,00	42,46	100,96	170,41	236,59
		25	0,50	88,53	274,95	120,00	58,77	140,79	213,45	274,95
		30	0,50	106,69	295,73	120,00	81,37	179,31	248,71	295,73
		5	0,25	29,71	41,96	120,00	8,09	22,99	27,16	41,96
		10	0,25	63,60	81,50	120,00	15,48	37,69	52,64	81,50
		15	0,25	97,49	129,18	120,00	23,26	53,71	83,13	129,18
		20	0,25	131,37	168,86	120,00	32,17	73,14	116,16	168,86
		25	0,25	165,26	196,44	120,00	42,97	96,45	146,75	196,44
		30	0,25	199,15	215,33	120,00	55,72	120,64	171,43	215,33
		5	0,25	29,71	43,62	120,00	8,25	23,49	28,17	43,62
		10	0,25	63,60	98,10	120,00	16,03	39,53	58,49	98,10
		15	0,25	97,49	192,77	120,00	24,53	58,85	103,54	192,77
		20	0,25	131,37	282,32	120,00	35,05	87,86	181,76	282,32
		25	0,25	165,26	316,77	120,00	48,96	130,96	260,06	316,77
		30	0,25	199,15	335,93	120,00	68,54	207,15	294,13	335,93

1) Momentum degree of fullness without contribution from channel dead weight
 2) Size of designated system's single load

Symbols and designation

- ϵ_{B,θ_a} Channel bending strain at elevated temperatures θ_a
- σ_B Channel bending stress
- V Momentum degree of fullness
- F Load
- $\delta_{t_{max};B}$ Deformation of the channel at the point in time of stability failure or of the plastic hinging
- $t_{max,B}$ Time in which loss of rigidity or plastic hinging of the channel occurs under bending stress
- δ_{30} Displacement after exposure time of 30 minutes to elevated temperatures
- δ_{60} Displacement after exposure time of 60 minutes to elevated temperatures
- δ_{90} Displacement after exposure time of 90 minutes to elevated temperatures
- δ_{120} Displacement after exposure time of 120 minutes to elevated temperatures
- a constant coefficient with 0,1 m



Thermal analyses as well as calculations are referring to the boundary conditions of STTC.

Hilti cantilevers MT-BR-30, MT-BR-40 and MT-BR-40 D with load introduction component

Bending characteristics of the cantilever in case of fire

Annex D1

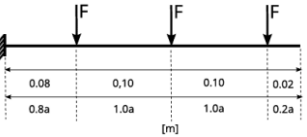
Table D19: Calculation-based deformation in case of fire for Hilti MT-BR-30 300 and MT-BR-30 300 OC cantilevers without suspension

System	Load direction	σ_B	$V^{1)}$	$F^{2)}$	$\delta_{t_{max};B}$	$t_{max,B}$	δ_{30}	δ_{60}	δ_{90}	δ_{120}
		MPa	-	N	mm	min	mm	mm	mm	mm
		5	0,33	8,25	45,60	120,00	9,07	24,94	30,00	45,60
		10	0,33	17,67	87,12	120,00	17,18	40,99	57,48	87,12
		15	0,33	27,08	130,98	120,00	25,72	58,29	88,44	130,98
		20	0,33	36,49	164,31	120,00	35,45	78,38	118,66	164,31
		25	0,33	45,91	187,53	120,00	47,00	100,77	144,55	187,53
		30	0,33	55,32	204,08	120,00	60,26	122,26	165,08	204,08
		5	0,33	8,25	46,91	120,00	9,13	25,23	30,72	46,91
		10	0,33	17,67	103,16	120,00	17,66	42,71	63,20	103,16
		15	0,33	27,08	178,77	120,00	26,96	63,42	107,81	178,77
		20	0,33	36,49	249,60	120,00	38,36	92,90	162,20	249,60
		25	0,33	45,91	286,34	120,00	53,05	131,65	226,82	286,34
		30	0,33	55,32	308,71	120,00	73,15	170,75	261,48	308,71

1) Momentum degree of fullness without contribution from channel dead weight

2) Size of designated system's single load







Symbols and designation see Annex D1

Hilti cantilevers MT-BR-30, MT-BR-40 and MT-BR-40 D with load introduction component

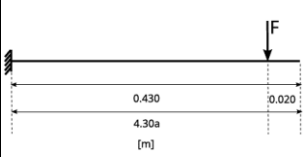
Bending characteristics of the cantilever in case of fire

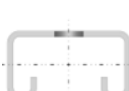
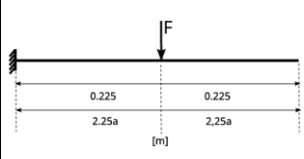
Annex D2

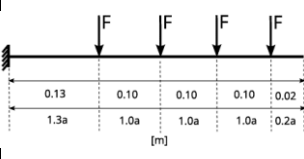
Table D20: Calculation-based deformation in case of fire for Hilti MT-BR-30 450 and MT-BR-30 450 OC cantilevers without additional suspension

System	Load direction	σ_B	$V^{1)}$	$F^{2)}$	$\delta_{t_{max};B}$	$t_{max,B}$	δ_{30}	δ_{60}	δ_{90}	δ_{120}
		MPa	-	N	mm	min	mm	mm	mm	mm
		5	0,50	8,54	77,26	120,00	17,81	42,37	55,18	77,26
		10	0,50	20,36	159,10	120,00	34,77	75,62	111,03	159,10
		15	0,50	32,18	235,09	120,00	52,57	110,50	169,23	235,09
		20	0,50	44,00	287,42	120,00	72,69	149,06	220,50	287,42
		25	0,50	55,83	321,67	120,00	96,18	188,77	261,29	321,67
		30	0,50	67,65	344,67	120,00	122,59	224,78	292,17	344,67
		5	0,50	8,54	78,94	120,00	17,79	42,58	55,95	78,94
		10	0,50	20,36	179,86	120,00	35,33	77,83	118,70	179,86
		15	0,50	32,18	284,42	120,00	54,22	117,69	193,26	284,42
		20	0,50	44,00	349,76	120,00	76,82	168,89	267,07	349,76
		25	0,50	55,83	386,92	120,00	104,91	225,66	322,91	386,92
		30	0,50	67,65	408,49	120,00	141,51	277,04	359,80	408,49
		5	0,25	16,32	66,41	120,00	14,76	36,34	46,51	66,41
		10	0,25	38,91	137,26	120,00	28,23	63,11	92,76	137,26
		15	0,25	61,51	215,45	120,00	42,49	92,29	146,39	215,45
		20	0,25	84,10	274,85	120,00	58,86	126,95	199,99	274,85
		25	0,25	106,69	314,23	120,00	78,43	166,41	246,38	314,23
		30	0,25	129,28	340,66	120,00	101,46	204,90	282,30	340,66
		5	0,25	16,32	68,70	120,00	14,94	36,93	47,82	68,70
		10	0,25	38,91	160,56	120,00	28,98	65,64	101,05	160,56
		15	0,25	61,51	280,28	120,00	44,34	99,80	174,08	280,28
		20	0,25	84,10	375,38	120,00	63,21	148,52	261,07	375,38
		25	0,25	106,69	423,66	120,00	87,47	211,50	340,36	423,66
		30	0,25	129,28	450,66	120,00	121,31	273,53	393,74	450,66
		5	0,33	3,28	76,03	120,00	17,37	41,47	54,02	76,03
		10	0,33	7,82	147,03	120,00	32,38	70,84	103,20	147,03
		15	0,33	12,36	209,97	120,00	48,21	101,67	153,03	209,97
		20	0,33	16,89	254,58	120,00	66,05	135,07	196,19	254,58
		25	0,33	21,43	286,26	120,00	86,55	168,86	231,21	286,26
		30	0,33	25,97	309,40	120,00	109,41	199,16	258,88	309,40
		5	0,33	3,28	76,76	120,00	17,02	41,06	53,94	76,76
		10	0,33	7,82	169,88	120,00	32,69	72,73	111,13	169,88
		15	0,33	12,36	266,18	120,00	49,72	109,26	180,19	266,18
		20	0,33	16,89	329,69	120,00	70,26	156,77	249,15	329,69
		25	0,33	21,43	379,47	120,00	95,78	209,87	302,68	379,47
		30	0,33	25,97	410,75	120,00	129,38	258,03	343,21	410,75

1) Momentum degree of fullness without contribution from channel dead weight

2) Size of designated system's single load







Symbols and designation see Annex D1

Hilti cantilevers MT-BR-30, MT-BR-40 and MT-BR-40 D with load introduction component

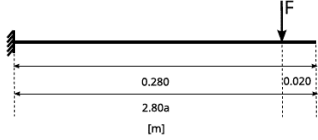
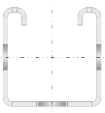
Bending characteristics of the cantilever in case of fire

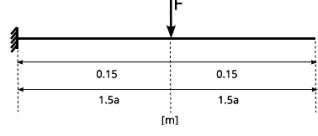
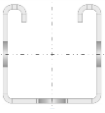
Annex D3

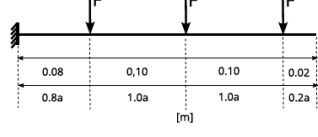
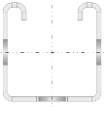
Table D21: Calculation-based deformation in case of fire for Hilti MT-BR-40 300 and MT-BR-40 300 OC cantilevers without additional suspension

System	Load direction	σ_B	$V^1)$	$F^2)$	$\delta_{t_{max},B}$	$t_{max,B}$	δ_{30}	δ_{60}	δ_{90}	δ_{120}
		MPa	-	N	mm	min	mm	mm	mm	mm
		5	0,50	45,07	34,01	120,00	6,20	22,10	29,76	34,01
		10	0,50	92,80	51,14	120,00	11,85	30,81	43,77	51,14
		15	0,50	140,53	72,49	120,00	17,69	40,57	59,87	72,49
		20	0,50	188,25	98,04	120,00	23,98	50,82	76,83	98,04
		25	0,50	235,98	127,63	120,00	31,21	63,08	98,46	127,63
		30	0,50	283,71	163,81	120,00	39,29	77,59	123,79	163,81
		5	0,50	45,07	34,12	120,00	6,25	22,17	29,84	34,12
		10	0,50	92,80	51,10	120,00	11,96	30,92	43,81	51,10
		15	0,50	140,53	71,56	120,00	17,81	40,61	59,48	71,56
		20	0,50	188,25	95,05	120,00	24,09	50,65	75,60	95,05
		25	0,50	235,98	120,70	120,00	31,20	62,32	94,98	120,70
		30	0,50	283,71	152,64	120,00	39,01	75,67	117,44	152,64
		5	0,25	84,13	33,37	120,00	5,76	21,60	29,17	33,37
		10	0,25	173,22	48,19	120,00	10,85	29,29	41,17	48,19
		15	0,25	262,31	65,76	120,00	16,10	37,71	54,62	65,76
		20	0,25	351,41	86,54	120,00	21,63	46,47	68,77	86,54
		25	0,25	440,50	111,25	120,00	27,69	56,34	85,76	111,25
		30	0,25	529,59	150,02	120,00	34,30	67,76	107,40	150,02
		5	0,25	84,13	33,43	120,00	5,80	21,65	29,23	33,43
		10	0,25	173,22	47,90	120,00	10,90	29,30	41,02	47,90
		15	0,25	262,31	64,30	120,00	16,11	37,54	53,86	64,30
		20	0,25	351,41	82,38	120,00	21,53	45,95	66,91	82,38
		25	0,25	440,50	101,58	120,00	27,35	55,07	81,20	101,58
		30	0,25	529,59	124,87	120,00	33,58	65,13	97,74	124,87
		5	0,33	23,37	33,80	120,00	6,01	21,90	29,55	33,80
		10	0,33	48,12	49,34	120,00	11,34	29,98	42,19	49,34
		15	0,33	72,86	67,97	120,00	16,88	38,88	56,51	67,97
		20	0,33	97,61	89,75	120,00	22,70	48,19	71,55	89,75
		25	0,33	122,36	113,77	120,00	29,14	58,78	89,34	113,77
		30	0,33	147,11	143,70	120,00	36,20	70,89	110,28	143,70
		5	0,33	23,37	33,80	120,00	6,02	21,91	29,55	33,80
		10	0,33	48,12	49,02	120,00	11,37	29,97	42,01	49,02
		15	0,33	72,86	66,59	120,00	16,90	38,72	55,79	66,59
		20	0,33	97,61	86,08	120,00	22,63	47,72	69,84	86,08
		25	0,33	122,36	106,20	120,00	28,87	57,59	85,32	106,20
		30	0,33	147,11	129,09	120,00	35,58	68,51	102,73	129,09

1) Momentum degree of fullness without contribution from channel dead weight

2) Size of designated system's single load





Symbols and designation see Annex D1

Hilti cantilevers MT-BR-30, MT-BR-40 and MT-BR-40 D with load introduction component

Bending characteristics of the cantilever in case of fire

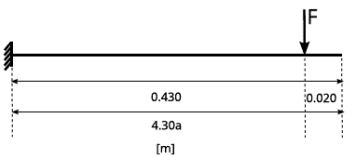
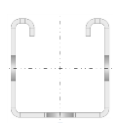
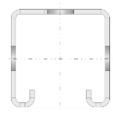
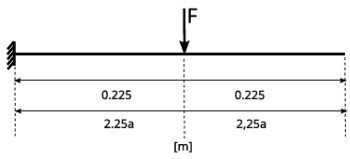
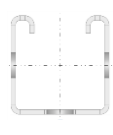
Annex D4

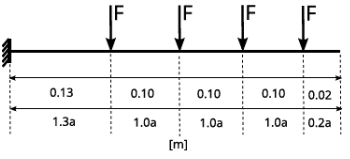
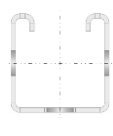
Table D22: Calculation-based deformation in case of fire for Hilti MT-BR-40 450 and MT-BR-40 450 OC cantilevers without additional suspension

System	Load direction	σ_B	$V^1)$	$F^2)$	$\delta_{t_{max};B}$	$t_{max,B}$	δ_{30}	δ_{60}	δ_{90}	δ_{120}
		MPa	-	N	mm	min	mm	mm	mm	mm
		5	0,50	27,18	42,23	120,00	10,02	27,10	36,48	42,23
		10	0,50	58,26	72,99	120,00	19,73	42,43	61,97	72,99
		15	0,50	89,34	112,91	120,00	29,89	60,08	91,79	112,91
		20	0,50	120,42	158,83	120,00	41,06	78,80	123,01	158,83
		25	0,50	151,50	206,62	120,00	54,37	101,74	161,47	206,62
		30	0,50	182,58	255,45	120,00	69,61	128,87	201,80	255,45
		5	0,50	27,18	42,34	120,00	10,06	27,16	36,56	42,34
		10	0,50	58,26	73,01	120,00	19,87	42,60	62,06	73,01
		15	0,50	89,34	111,97	120,00	30,09	60,21	91,42	111,97
		20	0,50	120,42	156,91	120,00	41,29	78,73	121,97	156,91
		25	0,50	151,50	216,91	120,00	54,46	100,98	160,29	216,91
		30	0,50	182,58	283,34	120,00	69,41	127,46	211,68	283,34
		5	0,25	51,95	40,69	120,00	8,98	25,92	35,10	40,69
		10	0,25	111,34	65,80	120,00	17,35	38,77	55,59	65,80
		15	0,25	170,74	97,08	120,00	26,10	53,17	79,31	97,08
		20	0,25	230,13	135,16	120,00	35,40	68,36	104,59	135,16
		25	0,25	289,53	180,59	120,00	45,97	86,30	136,65	180,59
		30	0,25	348,92	241,56	120,00	57,78	107,58	176,00	241,56
		5	0,25	51,95	40,79	120,00	9,03	25,99	35,18	40,79
		10	0,25	111,34	65,51	120,00	17,44	38,83	55,46	65,51
		15	0,25	170,74	95,12	120,00	26,16	53,02	78,35	95,12
		20	0,25	230,13	129,33	120,00	35,34	67,72	101,97	129,33
		25	0,25	289,53	166,56	120,00	45,62	84,54	129,86	166,56
		30	0,25	348,92	214,80	120,00	56,88	103,72	162,76	214,80
		5	0,33	10,44	42,05	120,00	9,71	26,82	36,26	42,05
		10	0,33	22,37	69,30	120,00	18,74	40,72	58,66	69,30
		15	0,33	34,30	102,77	120,00	28,07	56,31	84,24	102,77
		20	0,33	46,23	140,54	120,00	38,12	72,72	110,75	140,54
		25	0,33	58,16	177,47	120,00	49,64	91,96	141,51	177,47
		30	0,33	70,10	215,13	120,00	62,38	113,61	173,45	215,13
		5	0,33	10,44	41,87	120,00	9,64	26,73	36,11	41,87
		10	0,33	22,37	68,77	120,00	18,73	40,64	58,32	68,77
		15	0,33	34,30	101,11	120,00	28,07	56,09	83,34	101,11
		20	0,33	46,23	137,18	120,00	38,06	72,16	108,89	137,18
		25	0,33	58,16	173,27	120,00	49,35	90,60	138,02	173,27
		30	0,33	70,10	211,63	120,00	61,72	111,25	169,44	211,63

1) Momentum degree of fullness without contribution from channel dead weight

2) Size of designated system's single load



Symbols and designation see Annex D1

Hilti cantilevers MT-BR-30, MT-BR-40 and MT-BR-40 D with load introduction component

Bending characteristics of the cantilever in case of fire

Annex D5

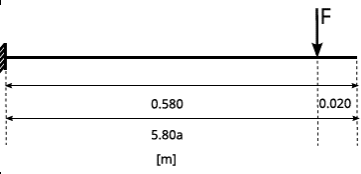
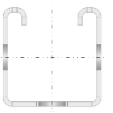
Table D23: Calculation-based deformation in case of fire for Hilti MT-BR-40 600, MT-BR-40 600 OC and MT-BR-40 O4 600 OC cantilevers without additional suspension

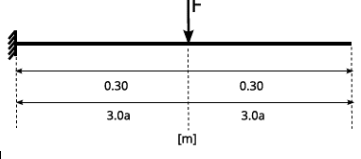
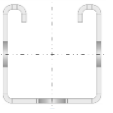
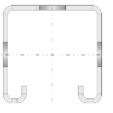
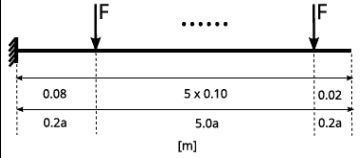
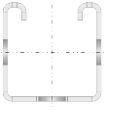
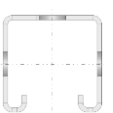
System	Load direction	σ_B	$V^1)$	$F^2)$	$\delta_{t_{max},B}$	$t_{max,B}$	δ_{30}	δ_{60}	δ_{90}	δ_{120}
		MPa	-	N	mm	min	mm	mm	mm	mm
		5	0,50	17,90	52,03	120,00	14,85	33,25	44,60	52,03
		10	0,50	40,94	99,56	120,00	29,24	56,52	84,28	99,56
		15	0,50	63,99	161,80	120,00	44,66	84,00	130,98	161,80
		20	0,50	87,03	229,42	120,00	61,84	113,13	178,52	229,42
		25	0,50	110,07	291,46	120,00	82,79	148,79	233,17	291,46
		30	0,50	133,11	349,99	120,00	106,79	189,54	286,48	349,99
		5	0,50	17,90	52,09	120,00	14,87	33,28	44,64	52,09
		10	0,50	40,94	99,67	120,00	29,41	56,74	84,45	99,67
		15	0,50	63,99	162,12	120,00	44,96	84,28	131,02	162,12
		20	0,50	87,03	246,53	120,00	62,26	113,54	181,42	246,53
		25	0,50	110,07	345,39	120,00	83,19	149,38	263,57	345,39
		30	0,50	133,11	393,00	120,00	107,20	197,98	339,58	393,00
		5	0,25	34,61	49,17	120,00	12,88	31,04	42,03	49,17
		10	0,25	79,16	87,05	120,00	25,17	50,12	73,19	87,05
		15	0,25	123,71	135,51	120,00	37,90	71,81	109,54	135,51
		20	0,25	168,25	193,75	120,00	51,75	94,83	148,42	193,75
		25	0,25	212,80	260,98	120,00	67,89	122,78	198,15	260,98
		30	0,25	257,35	338,15	120,00	86,06	155,94	254,57	338,15
		5	0,25	34,61	49,29	120,00	12,94	31,12	42,12	49,29
		10	0,25	79,16	86,82	120,00	25,30	50,25	73,13	86,82
		15	0,25	123,71	133,31	120,00	38,04	71,73	108,52	133,31
		20	0,25	168,25	187,56	120,00	51,79	94,20	145,46	187,56
		25	0,25	212,80	249,63	120,00	67,61	120,85	191,02	249,63
		30	0,25	257,35	336,17	120,00	85,14	151,64	244,82	336,17
 <p>Number of single forces = 6</p>		5	0,33	5,24	52,07	120,00	14,31	32,86	44,49	52,07
		10	0,33	11,99	92,63	120,00	27,50	53,44	78,12	92,63
		15	0,33	18,74	141,68	120,00	41,16	76,60	116,02	141,68
		20	0,33	25,49	192,42	120,00	55,99	100,90	153,69	192,42
		25	0,33	32,24	237,52	120,00	72,95	128,46	193,63	237,52
		30	0,33	38,99	279,40	120,00	91,62	157,92	231,94	279,40
		5	0,33	5,24	51,47	120,00	14,07	32,53	43,98	51,47
		10	0,33	11,99	92,04	120,00	27,43	53,30	77,75	92,04
		15	0,33	18,74	141,22	120,00	41,21	76,53	115,68	141,22
		20	0,33	25,49	193,47	120,00	56,13	100,80	153,72	193,47
		25	0,33	32,24	242,70	120,00	73,20	128,70	195,56	242,70
		30	0,33	38,99	290,35	120,00	92,01	158,98	237,18	290,35

1) Momentum degree of fullness without contribution from channel dead weight

2) Size of designated system's single load







Symbols and designation see Annex D1

Hilti cantilevers MT-BR-30, MT-BR-40 and MT-BR-40 D with load introduction component

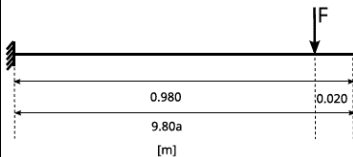
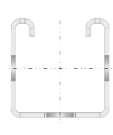
Bending characteristics of the cantilever in case of fire

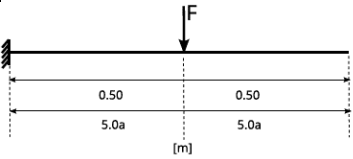
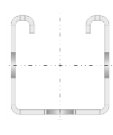
Annex D6

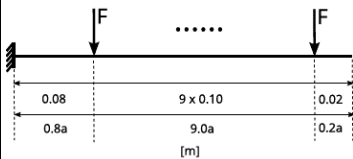
Table D24: Calculation-based deformation in case of fire for Hilti MT-BR-40 1000, MT-BR-40 1000 OC and MT-BR-40 O4 1000 OC cantilevers without additional suspension

System	Load direction	σ_B	$V^1)$	$F^2)$	$\delta_{t_{max},B}$	$t_{max,B}$	δ_{30}	δ_{60}	δ_{90}	δ_{120}
		MPa	-	N	mm	min	mm	mm	mm	mm
		5	0,50	5,19	85,70	120,00	31,49	54,34	72,81	85,70
		10	0,50	18,83	193,25	120,00	62,71	106,52	163,64	193,25
		15	0,50	32,46	325,16	120,00	96,58	168,27	265,89	325,16
		20	0,50	46,10	446,36	120,00	135,04	232,34	359,40	446,36
		25	0,50	59,74	538,79	120,00	182,42	305,90	450,49	538,79
		30	0,50	73,37	615,84	120,00	234,48	380,13	530,52	615,84
		5	0,50	5,19	85,18	120,00	31,23	54,02	72,31	85,18
		10	0,50	18,83	194,47	120,00	62,87	106,81	164,51	194,47
		15	0,50	32,46	365,29	120,00	97,25	169,92	277,68	365,29
		20	0,50	46,10	554,78	120,00	137,09	243,52	445,34	554,78
		25	0,50	59,74	645,64	120,00	188,39	383,20	563,17	645,64
		30	0,50	73,37	707,26	120,00	268,67	495,64	636,89	707,26
		5	0,25	10,17	80,67	120,00	28,42	50,79	68,31	80,67
		10	0,25	36,90	165,14	120,00	53,16	91,59	138,64	165,14
		15	0,25	63,63	273,76	120,00	79,71	138,88	219,41	273,76
		20	0,25	90,36	392,43	120,00	109,42	189,73	303,58	392,43
		25	0,25	117,08	505,61	120,00	145,51	252,01	401,12	505,61
		30	0,25	143,81	610,66	120,00	186,65	323,68	495,89	610,66
		5	0,25	10,17	80,82	120,00	28,45	50,86	68,40	80,82
		10	0,25	36,90	166,18	120,00	53,51	92,19	139,58	166,18
		15	0,25	63,63	279,12	120,00	80,36	139,84	221,31	279,12
		20	0,25	90,36	437,60	120,00	110,58	191,95	314,90	437,60
		25	0,25	117,08	619,38	120,00	146,76	256,03	461,38	619,38
		30	0,25	143,81	710,49	120,00	188,90	346,01	605,23	710,49
 <p>Number of single forces = 10</p>		5	0,33	0,96	95,32	120,00	34,47	58,97	80,99	95,32
		10	0,33	3,48	184,24	120,00	61,50	104,22	155,94	184,24
		15	0,33	6,00	272,91	120,00	90,14	152,53	228,29	272,91
		20	0,33	8,52	347,16	120,00	121,30	199,99	289,85	347,16
		25	0,33	11,05	405,76	120,00	156,34	248,30	345,10	405,76
		30	0,33	13,57	453,98	120,00	192,03	293,56	393,19	453,98
		5	0,33	0,96	89,59	120,00	32,35	55,94	76,01	89,59
		10	0,33	3,48	178,89	120,00	59,59	100,95	151,29	178,89
		15	0,33	6,00	274,59	120,00	88,45	150,30	227,96	274,59
		20	0,33	8,52	359,44	120,00	120,04	199,83	296,10	359,44
		25	0,33	11,05	427,42	120,00	156,09	252,34	359,47	427,42
		30	0,33	13,57	484,26	120,00	193,85	303,59	415,84	484,26

1) Momentum degree of fullness without contribution from channel dead weight

2) Size of designated system's single load

Symbols and designation see Annex D1

Hilti cantilevers MT-BR-30, MT-BR-40 and MT-BR-40 D with load introduction component

Bending characteristics of the cantilever in case of fire

Annex D7

Table D25: Calculation-based deformation in case of fire for Hilti MT-BR-40D 600, MT-BR-40D 600 OC and MT-BR-40D O4 600 OC cantilevers without additional suspension

System	Load direction	σ_B	$V^1)$	$F^2)$	$\delta_{t_{max};B}$	$t_{max,B}$	δ_{30}	δ_{60}	δ_{90}	δ_{120}
		MPa	-	N	mm	min	mm	mm	mm	mm
		5	0,50	50,82	24,32	120,00	9,90	13,72	19,38	24,32
		10	0,50	111,93	57,62	120,00	20,72	30,37	46,28	57,62
		15	0,50	173,05	100,90	120,00	32,25	49,84	78,75	100,90
		20	0,50	234,16	155,35	120,00	44,87	70,94	114,82	155,35
		25	0,50	295,28	242,85	120,00	59,37	95,90	164,22	242,85
		30	0,50	356,39	421,79	120,00	75,95	126,61	263,38	421,79
		5	0,50	50,82	24,45	120,00	9,99	13,82	19,50	24,45
		10	0,50	111,93	57,60	120,00	20,94	30,61	46,38	57,60
		15	0,50	173,05	99,63	120,00	32,55	50,00	78,26	99,63
		20	0,50	234,16	150,86	120,00	45,13	70,75	112,99	150,86
		25	0,50	295,28	223,55	120,00	59,63	95,29	157,94	223,55
		30	0,50	356,39	415,99	120,00	76,02	124,29	320,29	415,99
		5	0,25	98,24	23,14	120,00	9,08	12,79	18,31	23,14
		10	0,25	216,40	52,15	120,00	18,73	27,44	41,31	52,15
		15	0,25	334,56	88,48	120,00	29,05	44,17	68,60	88,48
		20	0,25	452,73	135,24	120,00	40,21	62,45	99,75	135,24
		25	0,25	570,87	205,25	120,00	52,61	83,56	138,49	205,25
		30	0,25	689,03	261,73	113,33	66,53	108,69	188,60	0,00
		5	0,25	98,24	23,16	120,00	9,14	12,85	18,36	23,16
		10	0,25	216,40	51,45	120,00	18,79	27,42	40,96	51,45
		15	0,25	334,56	85,16	120,00	29,01	43,73	66,87	85,16
		20	0,25	452,73	124,97	120,00	39,90	61,13	95,03	124,97
		25	0,25	570,87	175,73	120,00	51,80	80,51	128,00	175,73
		30	0,25	689,03	274,99	120,00	64,88	102,48	169,14	274,99
		5	0,33	14,89	24,18	120,00	9,60	13,45	19,18	24,18
		10	0,33	32,79	54,40	120,00	19,68	28,74	43,26	54,40
		15	0,33	50,69	92,67	120,00	30,56	46,43	72,21	92,67
		20	0,33	68,59	141,06	120,00	42,22	65,68	104,87	141,06
		25	0,33	86,50	224,88	120,00	55,30	87,99	147,13	224,88
		30	0,33	104,40	366,08	120,00	70,00	114,43	207,30	366,08
		5	0,33	14,89	23,94	120,00	9,55	13,37	19,02	23,94
		10	0,33	32,79	53,35	120,00	19,64	28,55	42,64	53,35
		15	0,33	50,69	88,93	120,00	30,41	45,80	70,14	88,93
		20	0,33	68,59	130,01	120,00	41,78	64,11	99,68	130,01
		25	0,33	86,50	176,93	120,00	54,29	84,43	133,02	176,93
		30	0,33	104,40	233,27	120,00	68,05	107,18	170,59	233,27

1) Momentum degree of fullness without contribution from channel dead weight

2) Size of designated system's single load

Symbols and designation see Annex D1

Hilti cantilevers MT-BR-30, MT-BR-40 and MT-BR-40 D with load introduction component

Bending characteristics of the cantilever in case of fire

Annex D8

Table D26: Calculation-based deformation in case of fire for Hilti MT-BR-40D 1000, MT-BR-40D 1000 OC and MT-BR-40D O4 1000 OC cantilevers without additional suspension

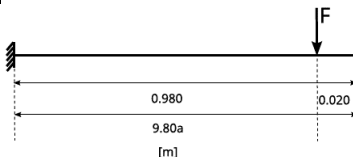
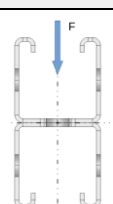
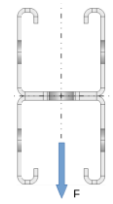
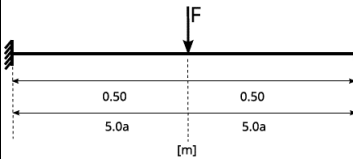
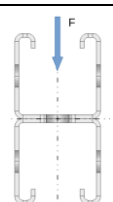
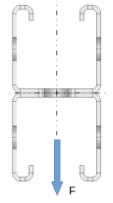
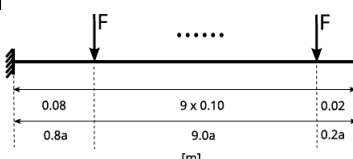
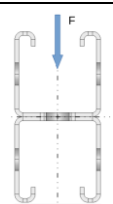
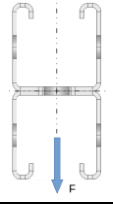
System	Load direction	σ_B	$V^1)$	$F^2)$	$\delta_{t_{max};B}$	$t_{max,B}$	δ_{30}	δ_{60}	δ_{90}	δ_{120}
		MPa	-	N	mm	min	mm	mm	mm	mm
		5	0,50	19,24	47,03	120,00	20,03	27,17	37,81	47,03
		10	0,50	55,41	115,92	120,00	41,76	61,20	94,42	115,92
		15	0,50	91,58	210,17	120,00	64,86	101,94	164,58	210,17
		20	0,50	127,75	328,23	120,00	90,61	146,38	242,61	328,23
		25	0,50	163,92	582,28	120,00	121,91	202,23	342,12	582,28
		30	0,50	200,09	720,66	120,00	158,33	270,42	564,74	720,66
		5	0,50	19,24	46,95	120,00	20,02	27,15	37,76	46,95
		10	0,50	55,41	115,94	120,00	41,90	61,42	94,55	115,94
		15	0,50	91,58	208,24	120,00	65,29	102,38	164,10	208,24
		20	0,50	127,75	321,36	120,00	91,22	146,58	239,67	321,36
		25	0,50	163,92	703,75	120,00	122,56	201,16	368,58	703,75
		30	0,50	200,09	765,24	120,00	158,54	266,72	659,54	765,24
		5	0,25	37,70	44,48	120,00	18,35	25,26	35,54	44,48
		10	0,25	108,00	101,54	120,00	36,68	53,61	81,62	101,54
		15	0,25	179,49	177,00	120,00	56,52	87,17	137,99	177,00
		20	0,25	250,39	271,86	120,00	78,14	123,60	200,45	271,86
		25	0,25	321,28	372,33	113,33	103,01	166,40	285,49	0,00
		30	0,25	392,17	376,23	86,67	131,20	218,12	0,00	0,00
		5	0,25	37,70	44,46	120,00	18,38	25,29	35,55	44,46
		10	0,25	108,00	100,88	120,00	36,80	53,68	81,30	100,88
		15	0,25	179,49	173,24	120,00	56,59	86,78	136,01	173,24
		20	0,25	250,39	262,41	120,00	77,87	122,10	195,80	262,41
		25	0,25	321,28	626,33	120,00	102,32	163,80	276,46	626,33
		30	0,25	392,17	745,27	120,00	129,84	213,42	516,76	745,27
 <p>Number of single forces = 10</p>		5	0,33	3,56	48,89	120,00	20,31	27,85	39,19	48,89
		10	0,33	10,25	110,67	120,00	40,09	58,59	89,30	110,67
		15	0,33	16,93	190,79	120,00	61,13	94,25	149,23	190,79
		20	0,33	23,62	296,33	120,00	84,31	133,55	218,12	296,33
		25	0,33	30,31	436,45	120,00	111,20	180,89	310,71	436,45
		30	0,33	37,00	539,22	120,00	141,75	238,20	416,59	539,22
		5	0,33	3,56	47,35	120,00	19,75	27,06	37,96	47,35
		10	0,33	10,25	107,60	120,00	39,53	57,52	87,10	107,60
		15	0,33	16,93	182,64	120,00	60,37	92,47	144,60	182,64
		20	0,33	23,62	268,86	120,00	83,00	129,97	206,09	268,86
		25	0,33	30,31	360,91	120,00	108,88	173,19	276,24	360,91
		30	0,33	37,00	463,71	120,00	137,76	221,71	351,04	463,71

1) Momentum degree of fullness without contribution from channel dead weight

2) Size of designated system's single load

Symbols and designation see Annex D1

Hilti cantilevers MT-BR-30, MT-BR-40 and MT-BR-40 D with load introduction component

Bending characteristics of the cantilever in case of fire

Annex D9

Table D27: Calculation-based deformation in case of fire for Hilti MT-BR-30 300 and MT-BR-30 300 OC cantilevers with suspension

System	Load direction	σ_B	$V^{1)}$	$F^{2)}$	$\delta_{t_{max};B}$	$t_{max,B}$	δ_{30}	δ_{60}	δ_{90}	δ_{120}
		MPa	-	N	mm	min	mm	mm	mm	mm
		5	0,50	104,28	3,90	120,00	2,22	3,90	3,90	3,90
		10	0,50	210,79	5,93	120,00	2,85	5,15	5,19	5,93
		15	0,50	317,30	10,53	120,00	3,47	6,42	7,68	10,53
		20	0,50	423,80	19,59	120,00	4,12	7,81	10,88	19,59
		25	0,50	530,31	46,02	120,00	4,87	9,62	16,05	46,02
		30	0,50	636,82	56,79	120,00	5,73	12,10	39,24	56,79
		5	0,50	104,28	4,10	120,00	2,33	4,10	4,10	4,10
		10	0,50	210,79	7,18	120,00	3,07	5,58	5,98	7,18
		15	0,50	317,30	13,73	120,00	3,84	7,18	9,17	13,73
		20	0,50	423,80	33,42	120,00	4,68	9,06	13,75	33,42
		25	0,50	530,31	25,95	93,33	5,65	11,56	23,36	-
		30	0,50	636,82	30,66	80,00	6,79	15,08	-	-
		5	0,55	66,92	3,88	120,00	2,21	3,88	3,88	3,88
		10	0,55	135,28	5,51	120,00	2,82	5,10	5,10	5,51
		15	0,55	203,63	9,94	120,00	3,43	6,32	7,39	9,94
		20	0,55	271,98	16,16	120,00	4,04	7,60	10,28	16,16
		25	0,55	340,33	29,65	120,00	4,69	9,07	14,00	29,65
		30	0,55	408,68	28,03	100,00	5,46	11,03	20,40	-
		5	0,55	66,92	4,34	120,00	2,44	4,34	4,34	4,34
		10	0,55	135,28	9,17	120,00	3,30	6,12	7,01	9,17
		15	0,55	203,63	20,60	120,00	4,23	8,11	11,69	20,60
		20	0,55	271,98	21,44	93,33	5,29	10,69	19,95	-
		25	0,55	340,33	21,49	73,33	6,67	14,84	-	-
		30	0,55	408,68	22,81	60,00	8,55	22,81	-	-
		5	0,61	63,91	3,90	120,00	2,22	3,90	3,90	3,90
		10	0,61	129,18	5,68	120,00	2,85	5,15	5,15	5,68
		15	0,61	194,45	10,27	120,00	3,47	6,40	7,56	10,27
		20	0,61	259,72	16,87	120,00	4,10	7,72	10,58	16,87
		25	0,61	324,99	32,12	120,00	4,77	9,25	14,47	32,12
		30	0,61	390,27	30,70	100,00	5,59	11,38	21,56	-
		5	0,61	63,91	4,04	120,00	2,29	4,04	4,04	4,04
		10	0,61	129,18	6,58	120,00	2,99	5,45	5,67	6,58
		15	0,61	194,45	12,53	120,00	3,70	6,90	8,64	12,53
		20	0,61	259,72	24,33	120,00	4,44	8,52	12,58	24,33
		25	0,61	324,99	70,91	113,33	5,27	10,52	18,52	-
		30	0,61	390,27	73,64	93,33	6,29	13,51	52,11	-

1) Momentum degree of fullness without contribution from channel dead weight

2) Size of designated system's single load

Symbols and designation see Annex D1

Suspended Hilti cantilevers MT-BR-30, MT-BR-40 and MT-BR-40 D with load introduction component

Bending characteristics of the suspended cantilever in case of fire

Annex D10

Table D28: Calculation-based deformation in case of fire for Hilti MT-BR-30 450 and MT-BR-30 450 OC cantilevers with suspension

System	Load direction	σ_B	$V^{1)}$	$F^{2)}$	$\delta_{t_{max};B}$	$t_{max,B}$	δ_{30}	δ_{60}	δ_{90}	δ_{120}
		MPa	-	N	mm	min	mm	mm	mm	mm
		5	0,50	58,69	6,90	120,00	3,28	6,02	6,26	6,90
		10	0,50	121,17	14,47	120,00	4,94	9,35	11,52	14,47
		15	0,50	183,65	27,56	120,00	6,60	12,71	18,19	27,56
		20	0,50	246,13	67,36	120,00	8,31	16,39	27,16	67,36
		25	0,50	308,61	103,74	120,00	10,31	21,33	50,26	103,74
		30	0,50	371,09	119,31	120,00	12,63	28,86	91,24	119,31
		5	0,50	58,69	7,22	120,00	3,35	6,17	6,50	7,22
		10	0,50	121,17	15,79	120,00	5,11	9,72	12,26	15,79
		15	0,50	183,65	31,23	120,00	6,89	13,41	19,89	31,23
		20	0,50	246,13	68,61	120,00	8,78	17,65	30,34	68,61
		25	0,50	308,61	151,33	120,00	11,01	23,45	51,29	151,33
		30	0,50	371,09	194,28	120,00	13,64	31,91	123,95	194,28
		5	0,48	55,45	6,10	120,00	3,05	5,57	5,61	6,10
		10	0,48	114,50	11,54	120,00	4,47	8,43	9,82	11,54
		15	0,48	173,54	20,82	120,00	5,90	11,28	15,08	20,82
		20	0,48	232,58	33,41	120,00	7,33	14,20	21,40	33,41
		25	0,48	291,62	53,63	120,00	8,79	17,42	28,99	53,63
		30	0,48	350,66	83,62	120,00	10,43	21,34	39,48	83,62
		5	0,48	55,45	7,65	120,00	3,39	6,28	6,73	7,65
		10	0,48	114,50	16,78	120,00	5,22	10,12	12,95	16,78
		15	0,48	173,54	37,51	120,00	7,18	14,34	22,42	37,51
		20	0,48	232,58	51,87	106,67	9,32	19,33	36,19	-
		25	0,48	291,62	44,03	80,00	11,78	25,78	-	-
		30	0,48	350,66	44,70	66,67	15,08	36,15	-	-
		5	0,61	20,90	4,94	120,00	2,73	4,92	4,92	4,94
		10	0,61	43,16	8,80	120,00	3,80	7,08	7,78	8,80
		15	0,61	65,42	13,56	120,00	4,87	9,22	11,16	13,56
		20	0,61	87,67	20,97	120,00	5,94	11,37	15,23	20,97
		25	0,61	109,93	29,82	120,00	7,02	13,53	19,75	29,82
		30	0,61	132,19	41,65	120,00	8,10	15,86	25,09	41,65
		5	0,61	20,90	7,09	120,00	3,31	6,10	6,39	7,09
		10	0,61	43,16	14,68	120,00	5,01	9,55	11,80	14,68
		15	0,61	65,42	28,88	120,00	6,73	13,05	18,95	28,88
		20	0,61	87,67	51,96	120,00	8,48	16,90	28,25	51,96
		25	0,61	109,93	105,54	120,00	10,40	21,51	40,92	105,54
		30	0,61	132,19	127,17	106,67	12,84	28,41	67,87	-

1) Momentum degree of fullness without contribution from channel dead weight

2) Size of designated system's single load

Symbols and designation see Annex D1

Suspended Hilti cantilevers MT-BR-30, MT-BR-40 and MT-BR-40 D with load introduction component

Bending characteristics of the suspended cantiliver in case of fire

Annex D11

Table D29: Calculation-based deformation in case of fire for Hilti MT-BR-40 300 and MT-BR-40 300 OC cantilevers with suspension

System	Load direction	σ_B	$V^{1)}$	$F^{2)}$	$\delta_{t_{max},B}$	$t_{max,B}$	δ_{30}	δ_{60}	δ_{90}	δ_{120}
		MPa	-	N	mm	min	mm	mm	mm	mm
		5	0,50	249,79	5,74	120,00	2,54	4,19	4,65	5,74
		10	0,50	502,53	7,59	120,00	2,98	5,01	6,19	7,59
		15	0,50	755,28	10,48	120,00	3,48	6,06	8,22	10,48
		20	0,50	1008,02	14,66	120,00	4,10	7,25	10,60	14,66
		25	0,50	1260,77	24,09	120,00	4,96	8,93	14,21	24,09
		30	0,50	1513,51	23,78	93,33	6,00	11,12	21,52	-
		5	0,50	249,79	6,00	120,00	2,63	4,33	4,87	6,00
		10	0,50	502,53	8,37	120,00	3,19	5,37	6,79	8,37
		15	0,50	755,28	11,94	120,00	3,85	6,66	9,20	11,94
		20	0,50	1008,02	16,95	120,00	4,69	8,24	12,25	16,95
		25	0,50	1260,77	24,68	120,00	5,78	10,38	16,66	24,68
		30	0,50	1513,51	37,82	120,00	7,08	13,13	22,46	37,82
		5	0,50	215,29	5,70	120,00	2,52	4,17	4,60	5,70
		10	0,50	433,12	7,16	120,00	2,93	4,85	5,92	7,16
		15	0,50	650,95	9,83	120,00	3,38	5,88	7,87	9,83
		20	0,50	868,79	13,30	120,00	3,91	6,95	9,97	13,30
		25	0,50	1086,62	18,27	120,00	4,53	8,12	12,46	18,27
		30	0,50	1304,45	30,35	120,00	5,42	9,86	16,62	30,35
		5	0,50	215,29	5,76	120,00	2,55	4,21	4,65	5,76
		10	0,50	433,12	7,42	120,00	2,99	4,98	6,13	7,42
		15	0,50	650,95	10,15	120,00	3,48	6,05	8,11	10,15
		20	0,50	868,79	13,54	120,00	4,05	7,16	10,22	13,54
		25	0,50	1086,62	18,18	120,00	4,73	8,38	12,65	18,18
		30	0,50	1304,45	24,55	120,00	5,68	10,17	16,46	24,55
		5	0,61	147,77	5,73	120,00	2,54	4,20	4,63	5,73
		10	0,61	297,29	7,54	120,00	2,98	4,99	6,18	7,54
		15	0,61	446,81	10,42	120,00	3,49	6,07	8,25	10,42
		20	0,61	596,33	14,57	120,00	4,08	7,23	10,57	14,57
		25	0,61	745,85	20,23	120,00	4,91	8,84	13,96	20,23
		30	0,61	895,37	30,69	120,00	5,95	10,98	18,87	30,69
		5	0,61	147,77	5,81	120,00	2,58	4,25	4,71	5,81
		10	0,61	297,29	7,88	120,00	3,06	5,15	6,45	7,88
		15	0,61	446,81	10,99	120,00	3,63	6,32	8,66	10,99
		20	0,61	596,33	15,43	120,00	4,29	7,58	11,14	15,43
		25	0,61	745,85	21,11	120,00	5,24	9,39	14,81	21,11
		30	0,61	895,37	30,78	120,00	6,40	11,74	19,94	30,78

1) Momentum degree of fullness without contribution from channel dead weight

2) Size of designated system's single load

Symbols and designation see Annex D1

Suspended Hilti cantilevers MT-BR-30, MT-BR-40 and MT-BR-40 D with load introduction component

Bending characteristics of the suspended cantilever in case of fire

Annex D12

Table D30: Calculation-based deformation in case of fire for Hilti MT-BR-40 450 and MT-BR-40 450 OC cantilevers with suspension

System	Load direction	σ_B	$V^{1)}$	$F^{2)}$	$\delta_{t_{max},B}$	$t_{max,B}$	δ_{30}	δ_{60}	δ_{90}	δ_{120}
		MPa	-	N	mm	min	mm	mm	mm	mm
		5	0,50	169,30	6,27	120,00	2,87	4,58	5,12	6,27
		10	0,50	342,91	9,78	120,00	3,71	6,13	8,04	9,78
		15	0,50	516,51	15,00	120,00	4,68	8,07	11,71	15,00
		20	0,50	690,11	26,16	120,00	5,84	10,27	16,31	26,16
		25	0,50	863,72	75,61	120,00	7,45	13,46	39,54	75,61
		30	0,50	1037,32	102,21	120,00	9,41	18,03	67,35	102,21
		5	0,50	169,30	6,46	120,00	2,94	4,67	5,28	6,46
		10	0,50	342,91	10,36	120,00	3,86	6,40	8,47	10,36
		15	0,50	516,51	15,96	120,00	4,92	8,47	12,36	15,96
		20	0,50	690,11	23,70	120,00	6,25	10,93	17,05	23,70
		25	0,50	863,72	33,96	120,00	8,03	14,32	23,77	33,96
		30	0,50	1037,32	49,47	120,00	10,13	18,59	32,31	49,47
		5	0,46	198,61	6,10	120,00	2,79	4,48	4,95	6,10
		10	0,46	402,27	8,41	120,00	3,52	5,57	7,08	8,41
		15	0,46	605,93	13,04	120,00	4,30	7,39	10,51	13,04
		20	0,46	809,59	18,90	120,00	5,23	9,29	14,20	18,90
		25	0,46	1013,24	27,82	120,00	6,25	11,27	18,42	27,82
		30	0,46	1216,90	52,47	120,00	7,63	14,01	25,59	52,47
		5	0,46	198,61	6,15	120,00	2,81	4,51	4,99	6,15
		10	0,46	402,27	8,54	120,00	3,56	5,66	7,18	8,54
		15	0,46	605,93	12,92	120,00	4,36	7,46	10,48	12,92
		20	0,46	809,59	17,94	120,00	5,30	9,32	13,90	17,94
		25	0,46	1013,24	24,54	120,00	6,32	11,23	17,59	24,54
		30	0,46	1216,90	32,47	120,00	7,66	13,61	22,36	32,47
		5	0,61	69,51	6,23	120,00	2,88	4,58	5,08	6,23
		10	0,61	140,78	9,65	120,00	3,71	6,09	7,99	9,65
		15	0,61	212,06	14,72	120,00	4,67	8,07	11,70	14,72
		20	0,61	283,33	22,00	120,00	5,75	10,19	15,88	22,00
		25	0,61	354,61	31,11	120,00	7,26	12,98	21,47	31,11
		30	0,61	425,88	46,97	120,00	9,21	16,86	29,82	46,97
		5	0,61	69,51	6,32	120,00	2,92	4,63	5,15	6,32
		10	0,61	140,78	10,03	120,00	3,80	6,27	8,29	10,03
		15	0,61	212,06	15,39	120,00	4,83	8,37	12,20	15,39
		20	0,61	283,33	22,99	120,00	6,00	10,60	16,56	22,99
		25	0,61	354,61	32,04	120,00	7,65	13,62	22,46	32,04
		30	0,61	425,88	45,86	120,00	9,73	17,74	30,92	45,86

¹⁾ Momentum degree of fullness without contribution from channel dead weight

²⁾ Size of designated system's single load

Symbols and designation see Annex D1

Suspended Hilti cantilevers MT-BR-30, MT-BR-40 and MT-BR-40 D with load introduction component

Bending characteristics of the suspended cantiliver in case of fire

Annex D13

Table D31: Calculation-based deformation in case of fire for Hilti MT-BR-40 600, MT-BR-40 600 OC and MT-BR-40 O4 600 OC cantilevers with suspension

System	Load direction	σ_B	$V^{1)}$	$F^{2)}$	$\delta_{t_{max},B}$	$t_{max,B}$	δ_{30}	δ_{60}	δ_{90}	δ_{120}
		MPa	-	N	mm	min	mm	mm	mm	mm
		5	0,50	114,64	7,30	120,00	3,50	5,30	6,02	7,30
		10	0,50	235,46	13,71	120,00	5,07	8,17	11,35	13,71
		15	0,50	356,28	24,93	120,00	6,88	11,77	18,31	24,93
		20	0,50	477,10	70,05	120,00	9,05	16,04	32,96	70,05
		25	0,50	597,92	102,29	120,00	12,01	24,04	69,43	102,29
		30	0,50	718,74	147,48	120,00	15,92	43,00	93,83	147,48
		5	0,50	114,64	7,47	120,00	3,58	5,41	6,18	7,47
		10	0,50	235,46	14,16	120,00	5,17	8,38	11,69	14,16
		15	0,50	356,28	23,61	120,00	7,05	12,04	18,41	23,61
		20	0,50	477,10	36,21	120,00	9,32	16,19	26,23	36,21
		25	0,50	597,92	52,43	120,00	12,31	21,75	36,94	52,43
		30	0,50	718,74	76,55	120,00	15,86	28,73	50,61	76,55
		5	0,43	185,17	6,86	120,00	3,28	5,05	5,61	6,86
		10	0,43	380,32	10,68	120,00	4,58	6,88	9,12	10,68
		15	0,43	575,47	18,83	120,00	5,96	10,04	15,16	18,83
		20	0,43	770,63	31,10	120,00	7,57	13,41	21,86	31,10
		25	0,43	965,78	74,47	120,00	9,36	16,99	31,90	74,47
		30	0,43	1160,93	100,16	120,00	11,68	22,18	67,92	100,16
		5	0,43	185,17	6,88	120,00	3,29	5,07	5,63	6,88
		10	0,43	380,32	10,56	120,00	4,59	6,89	9,03	10,56
		15	0,43	575,47	17,74	120,00	5,95	9,92	14,58	17,74
		20	0,43	770,63	25,75	120,00	7,51	13,07	20,26	25,75
		25	0,43	965,78	35,48	120,00	9,21	16,27	26,18	35,48
		30	0,43	1160,93	46,14	120,00	11,23	19,85	32,98	46,14
<p>Number of single forces = 5</p>		5	0,61	31,06	7,19	120,00	3,50	5,30	5,92	7,19
		10	0,61	63,79	13,28	120,00	5,04	8,03	11,15	13,28
		15	0,61	96,52	22,19	120,00	6,81	11,66	17,75	22,19
		20	0,61	129,25	34,04	120,00	8,76	15,42	25,03	34,04
		25	0,61	161,98	48,65	120,00	11,29	19,94	33,72	48,65
		30	0,61	194,71	67,95	120,00	14,64	26,33	46,37	67,95
		5	0,61	31,06	7,24	120,00	3,53	5,33	5,96	7,24
		10	0,61	63,79	13,57	120,00	5,11	8,18	11,39	13,57
		15	0,61	96,52	22,64	120,00	6,93	11,89	18,14	22,64
		20	0,61	129,25	34,62	120,00	8,94	15,73	25,51	34,62
		25	0,61	161,98	48,90	120,00	11,59	20,39	34,24	48,90
		30	0,61	194,71	66,32	120,00	15,06	26,94	46,74	66,32

¹⁾ Momentum degree of fullness without contribution from channel dead weight

²⁾ Size of designated system's single load

Symbols and designation see Annex D1

Suspended Hilti cantilevers MT-BR-30, MT-BR-40 and MT-BR-40 D with load introduction component

Bending characteristics of the suspended cantiliver in case of fire

Annex D14

Table D32: Calculation-based deformation in case of fire for Hilti MT-BR-40 1000, MT-BR-40 1000 OC and MT-BR-40 O4 600 OC cantilevers with suspension

System	Load direction	σ_B	$V^1)$	$F^2)$	$\delta_{t_{max};B}$	$t_{max,B}$	δ_{30}	δ_{60}	δ_{90}	δ_{120}
		MPa	-	N	mm	min	mm	mm	mm	mm
		5	0,50	60,76	10,87	120,00	5,74	7,89	9,15	10,87
		10	0,50	132,00	27,50	120,00	9,71	14,95	22,67	27,50
		15	0,50	203,24	57,19	120,00	14,34	24,75	42,26	57,19
		20	0,50	274,48	125,43	120,00	20,49	37,31	71,56	125,43
		25	0,50	345,72	199,56	120,00	28,68	54,70	129,38	199,56
		30	0,50	416,96	274,54	120,00	38,73	90,08	184,08	274,54
		5	0,50	60,76	10,85	120,00	5,75	7,89	9,14	10,85
		10	0,50	132,00	26,18	120,00	9,69	14,91	21,98	26,18
		15	0,50	203,24	47,59	120,00	14,19	23,73	38,09	47,59
		20	0,50	274,48	75,61	120,00	19,30	33,22	55,78	75,61
		25	0,50	345,72	109,15	120,00	25,96	45,11	77,76	109,15
		30	0,50	416,96	156,66	120,00	34,00	60,17	107,07	156,66
		5	0,41	160,19	9,49	120,00	4,94	6,99	7,87	9,49
		10	0,41	348,02	18,02	120,00	8,09	11,17	15,66	18,02
		15	0,41	535,85	40,15	120,00	11,29	18,36	30,47	40,15
		20	0,41	723,68	93,36	120,00	15,01	26,54	52,68	93,36
		25	0,41	911,51	136,77	120,00	19,23	36,58	96,74	136,77
		30	0,41	1099,34	166,76	120,00	25,08	67,35	131,28	166,76
		5	0,41	160,19	9,47	120,00	4,93	6,98	7,86	9,47
		10	0,41	348,02	17,25	120,00	8,03	10,99	15,06	17,25
		15	0,41	535,85	32,78	120,00	11,08	17,68	27,44	32,78
		20	0,41	723,68	49,51	120,00	14,58	24,82	39,91	49,51
		25	0,41	911,51	66,75	120,00	18,36	31,93	52,17	66,75
		30	0,41	1099,34	83,21	120,00	22,55	39,31	64,34	83,21
<p>Number of single forces = 9</p>		5	0,61	9,63	10,77	120,00	5,83	7,98	9,04	10,77
		10	0,61	20,93	25,19	120,00	9,64	14,57	21,53	25,19
		15	0,61	32,23	46,28	120,00	13,94	23,40	37,55	46,28
		20	0,61	43,52	71,23	120,00	18,70	32,61	54,54	71,23
		25	0,61	54,82	100,81	120,00	24,35	42,50	72,42	100,81
		30	0,61	66,12	130,16	120,00	31,85	55,66	94,81	130,16
		5	0,61	9,63	10,75	120,00	5,83	7,97	9,03	10,75
		10	0,61	20,93	25,50	120,00	9,71	14,72	21,80	25,50
		15	0,61	32,23	46,95	120,00	14,11	23,73	38,12	46,95
		20	0,61	43,52	72,43	120,00	18,97	33,10	55,37	72,43
		25	0,61	54,82	102,42	120,00	24,81	43,20	73,53	102,42
		30	0,61	66,12	131,81	120,00	32,57	56,87	96,67	131,81

1) Momentum degree of fullness without contribution from channel dead weight

2) Size of designated system's single load

Symbols and designation see Annex D1

Suspended Hilti cantilevers MT-BR-30, MT-BR-40 and MT-BR-40 D with load introduction component

Bending characteristics of the suspended cantiliver in case of fire

Annex D14

Table D33: Calculation-based deformation in case of fire for Hilti MT-BR-40D 600, MT-BR-40D 600 OC and MT-BR-40D O4 600 OC cantilevers with suspension

System	Load direction	σ_B	$V^{1)}$	$F^{2)}$	$\delta_{t_{max};B}$	$t_{max,B}$	δ_{30}	δ_{60}	δ_{90}	δ_{120}
		MPa	-	N	mm	min	mm	mm	mm	mm
		5	0,50	308,08	5,14	120,00	0,83	2,11	5,14	5,14
		10	0,50	628,54	8,10	120,00	1,75	3,72	8,10	8,10
		15	0,50	949,01	13,13	106,67	2,80	5,81	12,47	-
		20	0,50	1269,48	10,90	66,67	4,09	8,62	-	-
		25	0,50	1589,94	9,52	46,67	5,88	-	-	-
		30	0,50	1910,41	9,97	33,33	8,70	-	-	-
		5	0,50	308,08	5,44	120,00	0,97	2,31	5,44	5,44
		10	0,50	628,54	8,86	120,00	2,06	4,21	8,86	8,86
		15	0,50	949,01	13,38	120,00	3,33	6,63	13,38	13,38
		20	0,50	1269,48	24,40	120,00	4,87	9,58	19,54	24,40
		25	0,50	1589,94	57,59	120,00	6,87	13,69	30,59	57,59
		30	0,50	1910,41	114,87	113,33	9,31	19,37	51,28	-
		5	0,43	497,61	5,18	120,00	0,79	2,11	5,18	5,18
		10	0,43	1015,24	8,89	93,33	1,70	3,63	8,65	-
		15	0,43	1532,87	5,81	53,33	2,84	-	-	-
		20	0,43	2050,49	1,32	20,00	-	-	-	-
		25	0,43	2568,12	2,08	20,00	-	-	-	-
		30	0,43	3085,74	1,18	13,33	-	-	-	-
		5	0,43	497,61	5,08	120,00	0,75	2,06	5,08	5,08
		10	0,43	1015,24	7,30	120,00	1,57	3,30	7,30	7,30
		15	0,43	1532,87	10,96	120,00	2,48	5,19	10,96	10,96
		20	0,43	2050,49	18,75	100,00	3,58	7,48	16,06	-
		25	0,43	2568,12	16,37	73,33	4,91	10,36	-	-
		30	0,43	3085,74	16,00	53,33	8,20	-	-	-
		5	0,61	83,46	5,08	120,00	0,83	2,12	5,08	5,08
		10	0,61	170,28	7,91	120,00	1,74	3,63	7,91	7,91
		15	0,61	257,09	11,89	120,00	2,77	5,73	11,89	11,89
		20	0,61	343,91	18,28	120,00	3,91	8,04	16,55	18,28
		25	0,61	430,72	30,10	120,00	5,42	10,89	22,70	30,10
		30	0,61	517,54	39,01	100,00	7,45	15,13	34,08	-
		5	0,61	83,46	5,17	120,00	0,89	2,18	5,17	5,17
		10	0,61	170,28	8,20	120,00	1,86	3,82	8,20	8,20
		15	0,61	257,09	12,32	120,00	2,96	6,03	12,32	12,32
		20	0,61	343,91	19,23	120,00	4,19	8,44	17,13	19,23
		25	0,61	430,72	42,31	120,00	5,82	11,50	24,34	42,31
		30	0,61	517,54	125,09	120,00	7,93	15,92	42,43	125,09

¹⁾ Momentum degree of fullness without contribution from channel dead weight

²⁾ Size of designated system's single load

Symbols and designation see Annex D1

Suspended Hilti cantilevers MT-BR-30, MT-BR-40 and MT-BR-40 D with load introduction component

Bending characteristics of the suspended cantilever in case of fire

Annex D15

Table D34: Calculation-based deformation in case of fire for Hilti MT-BR-40D 1000, MT-BR-40D 1000 OC and MT-BR-40D O4 1000 OC cantilevers with suspension

System	Load direction	σ_B	$V^{1)}$	$F^{2)}$	$\delta_{t_{max},B}$	$t_{max,B}$	δ_{30}	δ_{60}	δ_{90}	δ_{120}
		MPa	-	N	mm	min	mm	mm	mm	mm
		5	0,50	167,95	6,67	120,00	1,93	3,39	6,67	6,67
		10	0,50	356,91	13,47	120,00	4,02	7,03	13,47	13,47
		15	0,50	545,86	43,11	120,00	6,49	12,01	27,07	43,11
		20	0,50	734,82	75,11	120,00	9,66	21,32	53,69	75,11
		25	0,50	923,78	103,49	100,00	14,49	41,32	81,99	-
		30	0,50	1112,74	109,75	80,00	29,36	55,73	-	-
		5	0,50	167,95	6,80	120,00	2,00	3,47	6,80	6,80
		10	0,50	356,91	13,81	120,00	4,21	7,32	13,81	13,81
		15	0,50	545,86	24,46	120,00	6,71	12,19	22,78	24,46
		20	0,50	734,82	45,21	120,00	9,70	17,71	33,79	45,21
		25	0,50	923,78	111,91	113,33	13,60	25,26	56,84	-
		30	0,50	1112,74	147,52	93,33	18,30	35,90	127,25	-
		5	0,41	442,80	6,24	120,00	1,59	3,04	6,24	6,24
		10	0,41	941,00	10,11	80,00	3,43	5,74	-	-
		15	0,41	1439,20	7,16	40,00	5,63	-	-	-
		20	0,41	1937,40	2,39	20,00	-	-	-	-
		25	0,41	2435,60	3,98	20,00	-	-	-	-
		30	0,41	2933,81	2,36	13,33	-	-	-	-
		5	0,41	442,80	6,15	120,00	1,56	2,99	6,15	6,15
		10	0,41	941,00	10,18	120,00	3,29	5,32	10,18	10,18
		15	0,41	1439,20	17,36	120,00	5,11	9,09	17,36	17,36
		20	0,41	1937,40	27,41	100,00	7,22	13,46	25,86	-
		25	0,41	2435,60	31,69	80,00	9,60	18,35	-	-
		30	0,41	2933,81	24,93	60,00	12,45	24,93	-	-
<p>Number of single forces = 9</p>		5	0,61	26,63	6,56	120,00	1,96	3,40	6,56	6,56
		10	0,61	56,60	13,06	120,00	3,99	6,83	13,06	13,06
		15	0,61	86,56	22,78	120,00	6,37	11,69	21,97	22,78
		20	0,61	116,52	38,83	120,00	9,00	16,84	32,03	38,83
		25	0,61	146,49	61,55	120,00	12,20	22,58	43,96	61,55
		30	0,61	176,45	96,92	106,67	16,66	31,37	65,12	-
		5	0,61	26,63	6,61	120,00	1,99	3,44	6,61	6,61
		10	0,61	56,60	13,27	120,00	4,07	6,97	13,27	13,27
		15	0,61	86,56	23,08	120,00	6,51	11,90	22,26	23,08
		20	0,61	116,52	39,54	120,00	9,19	17,11	32,37	39,54
		25	0,61	146,49	89,25	120,00	12,51	23,03	45,81	89,25
		30	0,61	176,45	211,45	120,00	17,02	32,04	89,43	211,45

¹⁾ Momentum degree of fullness without contribution from channel dead weight

²⁾ Size of designated system's single load

Symbols and designation see Annex D1

Suspended Hilti cantilevers MT-BR-30, MT-BR-40 and MT-BR-40 D with load introduction component

Bending characteristics of the suspended cantilever in case of fire

Annex D16



European Technical Assessment

ETA-23/0104 of 04/09/2023

English translation prepared by CSTB - Original version in French language

General Part

Technical Assessment Body issuing the European Technical Assessment:

Centre Scientifique et Technique du Bâtiment (CSTB)

Trade name of the construction product: Hilti Frame Trapeze of MT System with load introduction component

Product family to which the construction product belongs: Products for installation systems for supporting technical building equipment

Manufacturer: Hilti AG Liechtenstein
Feldkircherstraße 100
9494 Schaan
FÜRSTENTUM LIECHTENSTEIN

Manufacturing plants: L 1000446, L 1027881, L 1124303, L 1087643,
L 1006522, L 1128868, L 1066663

This European Technical Assessment contains: 59 pages including 56 pages of annexes which form an integral part of this assessment

This European Technical Assessment is issued in accordance with Regulation (EU) No 305/2011, on the basis of: European Assessment Document (EAD)
280016-00-0602 version June 2020

This version replaces: -

The European Technical Assessment is issued by the Technical Assessment Body in its official language. Translations of this European Technical Assessment in other languages shall fully correspond to the original issued document and shall be identified as such. Communication of this European Technical Assessment, including transmission by electronic means, shall be in full. However, partial reproduction may only be made with the written consent of the issuing Technical Assessment Body. Any partial reproduction shall be identified as such. This European Technical Assessment may be withdrawn by the issuing Technical Assessment Body, in particular pursuant to information by the Commission in accordance with Article 25(3) of Regulation (EU) No 305/2011.

Specific Part

1 Technical description of the product

This European Technical Assessment covers HILTI MT frame trapezes with load introduction component. Hilti MT frame trapezes consists of at least three installation channels. In a typical setup one horizontally aligned MT installation channel is positioned in-between two vertically aligned MT installation channels. The vertical and horizontal channels are attached to each other by using corresponding angle connectors and channel connectors. The frame trapeze is fixed to the ceiling using corresponding baseplates.

A MT frame trapeze with open profile channels consists of at least two vertical MT-50 S, MT-50, MT-50 S OC or MT-50 OC channels and at least one horizontal MT-40 D, MT-40 D S, MT-40 D OC, or MT-40 D S OC channel connected by using either MT-C-GS OC angle connector and MT-TL M10 or MT-TL M10 OC channel connectors. Alternatively a horizontal MT-50 S, MT-50, MT-50 S OC, MT-50 OC channel can be used, which is connected to the vertical channels by using either MT-C-GS OC angle connector and MT-TL M10 or MT-TL M10 OC channel connectors or alternatively the MT-AB A set or MT-AB A OC set. The MT-40 D, MT-40 D S, MT-40 D OC and MT-40 D S OC channel consists of two profiles, which are connected in the area of the holes in the back of the channels in a shape-fitting and force-fitting way as a kind of riveted connection. The vertical channels are connected to the ceiling with MT-B-T, MT-B-T OC, MT-B-O2, MT-B-O2 OC, MT-B-O2B, MT-B-O2B OC, MT-B-O4 or MT-B-O4 OC baseplates and two MT-TL M10 or MT-TL M10 OC channel connectors. Alternatively, the MT-AB A set or MT-AB A OC set can be used. The span width corresponds to the clear distance between the vertical channels and can be up to 2,10 m for MT-40 D, MT-40 D S, MT-40 D OC, MT-40 D S OC and maximum 1,50 m for MT-50 S, MT-50, MT-50 S OC and MT-50 OC. The load is applied to the horizontal channel by means of Hilti threaded rod(s), which are fastened to the channel by using MQZ-L drilled plates and hexagonal nuts or MQA-B saddle nuts.

The MT frame trapeze with closed profile channels consists of at least two vertical MT-70 OC or MT-70 S OC channels and at least either one MT-70 OC or MT-70 S OC or one MT-80 OC or MT-80 S OC channel which are connected by using MT-C-GSP L A angles and MT-TFB connectors. The vertical channels are connected to the ceiling using either MT-B-GS O4U OC or MT-B-GS T OC baseplates with MT-TFB connectors. The span width corresponds to the clear distance between the vertical channels and can be up to 2,0 m for MT-70 S OC, MT-70 OC and max. 2,50 m for MT-80 S OC, MT-80 OC. The load is applied to the horizontal channel by means of Hilti threaded rod(s), which are fixed to the channel by MT-PCC-G, MT-CTR-GS or MT-CTR-GL saddle nuts and MT-TFB connectors.

The MT frame trapeze may also consist of more than only two vertical and one horizontal frame (i.e. in case of multi-layer frame trapeze).

Annex A describes the dimensions and materials of above mentioned Hilti MT frame trapezes.

2 Specification of the intended use

The performance given in Section 3 can only be assumed if the Hilti MT frame trapezes are used in compliance with the specifications and under boundary conditions set out in Annexes A to C. The test and assessment methods on which this European Technical Assessment is based lead to an assumption of a working life of the Hilti cantilevers of MT System of at least 50 years in final use under ambient temperatures in indoor areas. The indications given on the working life cannot be interpreted as a guarantee given by the producer, but are to be regarded only as a means for choosing the right products in relation to the expected economically reasonable working life of the works.

In accordance with the European Assessment Document EAD 280016-00-0602, the product is intended to be used in

- a) installations for the support of sprinkler kits,
- b) installations for the support of pipes for the transport of gas/fuel intended for the supply of building heating/cooling systems.

3 Performance of the product and references to the methods used for its assessment

3.1 Safety in case of fire (BWR 2)

No.	Essential characteristic	Performance
1	Reaction to fire	Class A1
2	Resistance and deformation under fire exposure	See Annex C See Annex D

3.2 Safety and accessibility in use (BWR 4)

No.	Essential characteristic	Performance
3	Shape	See Annex A
4	Dimension	See Annex A
5	Material	See Annex A

4 Assessment and verification of constancy of performance (AVCP) system applied, with reference to its legal base

In accordance with the European Assessment Document EAD 280016-00-0602, the following legal bases apply:

- In case of intended use a) specified in Section 2:
Decision of the commission N° 1996/577/EC as amended by Commission Decision 2002/592/EC.:
System 1 applies for the assessment and verification of constancy of performance (AVCP).
- In case of intended use b) specified in Section 2:
Decision of the commission N° 1999/472/EC as amended by Commission Decision 001/596/EC:
System 3 applies for the assessment and verification of constancy of performance (AVCP).

5 Technical details necessary for the implementation of the AVCP system, as provided for in the applicable EAD

The technical details necessary for the implementation of the system for the assessment and verification of constancy of performance are laid down in the control plan (confidential part of this European Technical Assessment) deposited at Centre Scientifique et Technique du Bâtiment.

The manufacturer shall, on the basis of a contract, involve a notified body approved in the field of supporting systems for issuing the certificate of conformity CE based on the control plan.

The original French version is signed by

La cheffe de division, Anca CRONOPOL

Table A1: Dimensions and materials of Hilti MT-50 S, MT-50, MT-50 S OC, MT-50 OC, MT-40D S, MT-40D, MT-40D S OC, MT-40 D OC, MT-70 S OC, MT-70 OC, MT-80 S OC and MT-80 OC, installation channels

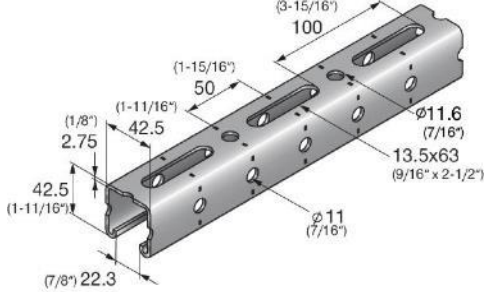
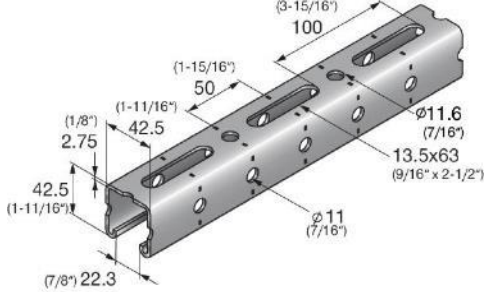
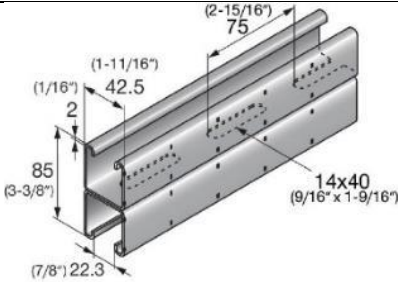
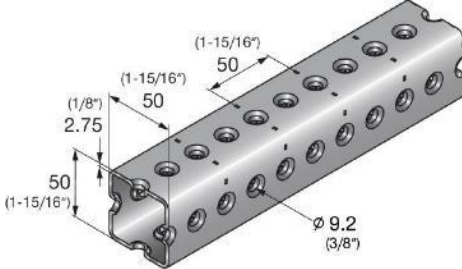
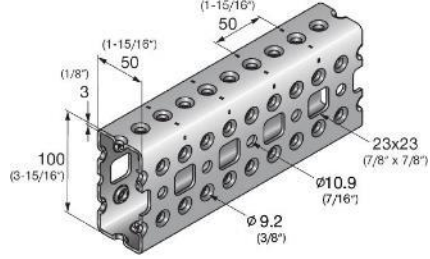
Item number	Designation	Length [m]	Materials and coatings	Illustration (Dimensions in mm and inch)
2268509	MT-50 S	3	S280GD or equivalent as defined in HN704 + Z275-M-A-C acc. to EN 10346	
2268510	MT-50	6		
2268511	MT-50 S OC	3	S280GD or equivalent as defined in HN704 + ZM310-A-C acc. to EN 10346	
2268512	MT-50 OC	6		
2268517	MT-40D S	3	S280GD or equivalent as defined in HN704 + Z275-M-A-C acc. to EN 10346	
2268518	MT-40D	6		
2268519	MT-40D S OC	3	S280GD or equivalent as defined in HN704 + ZM310-A-C acc. to EN 10346	<p>Two profiles of MT-40 channel are connected in the area of the holes in the back of the channels in a shape-fitting and force-fitting way as a kind of riveted connection.</p>
2268520	MT-40D OC	6		
2268364	MT-70 S OC	3	S350GD+ ZM310-A-C acc. to EN 10346	
2268365	MT-70 OC	6		
2268366	MT-80 S OC	3	S350GD+ ZM310-A-C acc. to EN 10346	
2268367	MT-80 OC	6		

Hilti MT frame trapezes with load introduction component

Product Description
 Dimensions and materials

Annex A1

Table A2: Dimensions and materials of Hilti MQA-B saddle nuts

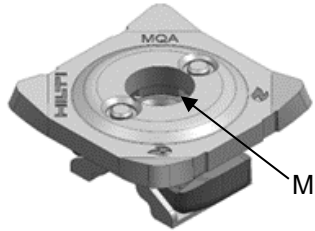
Item number	Designation	M thread	Materials	Illustration
2199452	MQA-M10-B	M10	Plate: DD11 according to DIN EN 10111 ¹⁾ or S235JR according to DIN EN 10025-2 Nut: C4C according to DIN EN 10263-2 Plastic part: PET	
2199453	MQA-M12-B	M12		
2199454	MQA-M16-B	M16		

¹⁾ with $235 < R_{eL} < 340 \text{ N/mm}^2$, Deoxidisation type: fully deoxidised

Table A3: Dimensions of the components of the MQA-M10-B and MQA-M12-B saddle nuts in mm

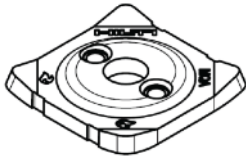
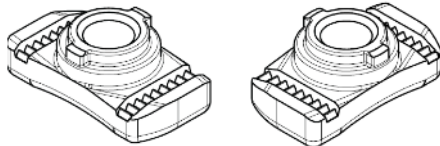
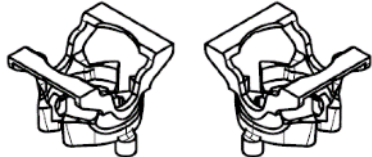
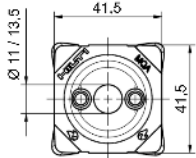
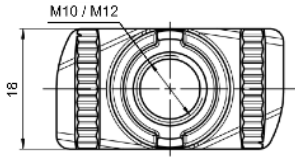
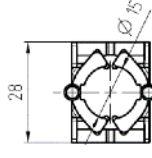
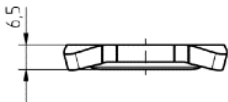
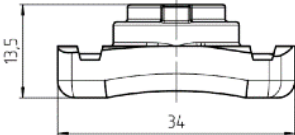
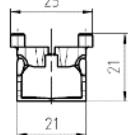
Plate	Nut	Spring section
		
		
		

Hilti MT frame trapezes with load introduction component

Product Description
 Dimensions and materials

Annex A2

Table A4: Dimensions of the components of the MQA-M16-B saddle nut in mm

Plate	Nut	Spring
		
		
		

Table A5: Dimensions and materials of the components of the MT-PCC-G M8/M10 OC, MT-PCC-G M12 OC and MT-PCC-G M16 OC saddle nut

Item number	Designation	M thread	Baseplate thickness	Materials	Illustration (Dimensions in mm)
2353801	MT-PCC-G M8/M10 OC	M10	4 mm	Baseplate: Q355B acc. to GB/T 1591 hot dipped galv. Connection piece: 9SMN28 acc. to DIN 1651 hot dipped galv.	
2354564	MT-PCC-G M12 OC	M12	4 mm		
2354155	MT-PCC-G M16 OC	M16	6 mm		

Hilti MT frame trapezes with load introduction component

Product Description
 Dimensions and materials

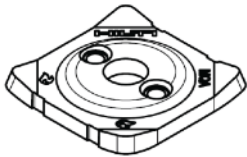
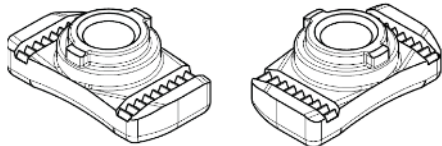
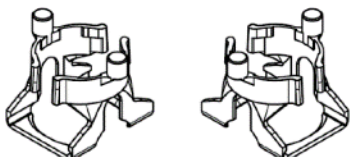
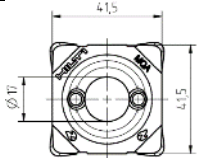
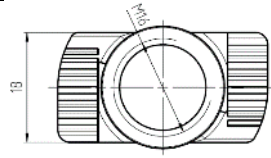
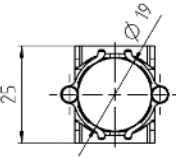
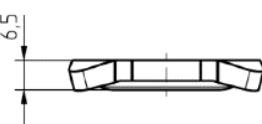
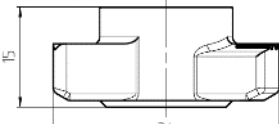
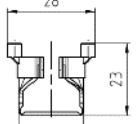
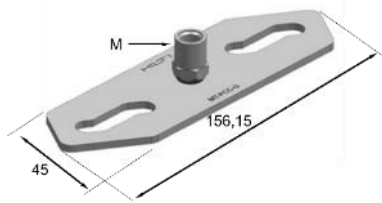
Annex A3

Table A6: Dimensions and materials of MT-CTR GS M12 OC, MT-CTR GS M16 OC, MT-CTR GL M12 OC and MT-CTR-GL M16 OC saddle nut

Item number	Designation	M thread	Materials	Illustration (Dimensions in mm and inch)
2332789	MT-CTR-GS M12 OC	M12		
2332790	MT-CTR-GS M16 OC	M16	U-shape steel plate: Q355B acc. to GB/T 1591 Hot dipped galvanized Hexagonal Nut: Strength class 8 acc. to ISO898-2	
2332793	MT-CTR-GL M12 OC	M12	Washer 12/40 and 16/40 acc. to ISO 7089-200HV Plate: Q235B acc. to GB/T 700 Hot dipped galvanized	
2332796	MT-CTR-GL M16 OC	M16		

Hilti MT frame trapezes with load introduction component

Product Description
 Dimensions and materials

Annex A4

Table A7: Dimensions and materials of Hilti MT-B-T, MT-B-T OC, MT-B-O2, MT-B-O2 OC, MT-B-O2B, MT-B-O2B OC, MT-B-O4 and MT-B-O4 OC baseplates for use with Hilti MT-50 installation channel product family

Item number	Designation	Materials	Illustration (Dimensions in mm and inch)
2272090	MT-B-T	Steel Q235B acc. to GB/T 700; galvanized	
2272092	MT-B-T OC	Steel Q235B acc. to GB/T 700; hot dip galvanized	
2272094	MT-B-O2	Steel Q235B acc. To GB/T 700; galvanized	
2272096	MT-B-O2 OC	Steel Q235B acc. to GB/T 700; hot dip galvanized	
2282212	MT-B-O2B	Steel Q235B acc. to GB/T 700; galvanized	
2282213	MT-B-O2B OC	Steel Q235B acc. to GB/T 700; hot dip galvanized	
2272098	MT-B-O4	Steel Q235B acc. to GB/T 700 galvanized	
2272099	MT-B-O4 OC	Steel Q235B acc. to GB/T 700 hot dip galvanized	

Hilti MT frame trapezes with load introduction component

Product Description
 Dimensions and materials

Annex A5

Table A8: Dimensions and materials of Hilti MT-B-GS O4U OC, MT-B-GS T OC baseplates for use with Hilti MT-70 and MT-80 installation channel product family

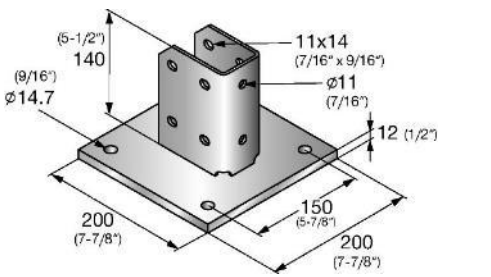
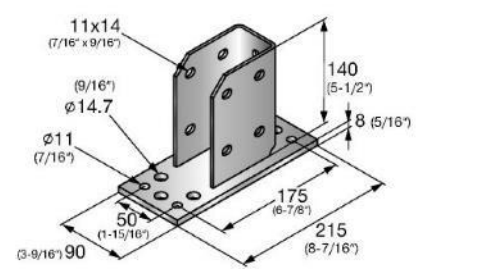

Item number	Designation	Materials and coatings	Illustration (Dimensions in mm and inch)
2272101	MT-B-GS O4U OC	Steel Q355B acc. to GB/T 1591; hot dip galvanized	
2272100	MT-B-GS T OC	Q355B acc. to GB/T 1591; hot dip galvanized	

Hilti MT frame trapezes with load introduction component

Product Description
 Dimensions and materials

Annex A6

Table A9: Dimensions and materials of Hilti MT-TL M10, MT-TL M10 OC, MT-TFB OC, MT-TLB, MT-TLB OC, MT-TLB 30 and MT-TLB 30 OC channel connector

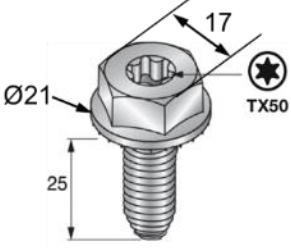
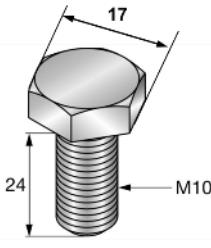
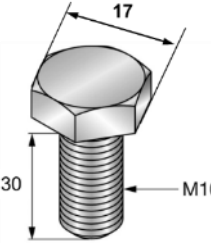

Item number	Designation	Materials and coatings	Illustration (Dimensions in mm)
2272080	MT-TL M10	Steel part: S460MC acc. to EN10149-2 zinc coated Plastic part: Polyamid	
2272082	MT-TL M10 OC	Steel part: S460MC acc. to EN10149-2 zinc coated with organic topcoat Plastic part: Polyamid	
2272084	MT-TFB OC	C10B21 acc. to SAE J403, Surface hardness min. 530 HV, Core hardness min. 32-39 HRC zinc coated with organic topcoat	
2273254	MT-TLB	strength class 8.8 acc. to EN ISO 898-1, zinc coated	
2273256	MT-TLB OC	strength class 8.8 acc. to EN ISO 898-1, zinc coated with organic topcoat	
2282190	MT-TLB 30	strength class 8.8 acc. to EN ISO 898-1, zinc coated	
2282191	MT-TLB 30 OC	strength class 8.8 acc. to EN ISO 898-1, zinc coated with organic topcoat	

Hilti MT frame trapezes with load introduction component

Product Description
 Dimensions and materials

Annex A7

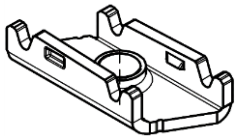
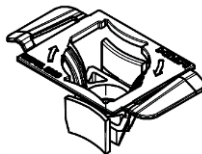
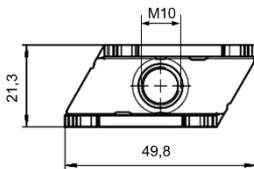
Table A10: Dimensions and material of components of Hilti MT-TL M10 and MT-TL M10 OC, channel connectors

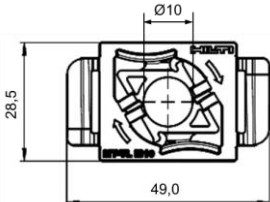
Item number	Designation	Illustration of nut (Dimensions in mm)	Illustration of plastic part (Dimensions in mm)
2272080 2272082	MT-TL M10 MT-TL M10 OC		
			
			

Hilti MT frame trapezes with load introduction component

Product Description
 Dimensions and materials

Annex A8

Table A11: Dimensions and material MT-C-GS OC and MT-C-GSP L A connectors

Item number	Designation	Materials and coatings	Illustration (Dimensions in mm and inch)
2272064	MT-C-GS OC	Steel Q355B acc. to GB/T 1591 hot dip galvanized	
2332786	MT-C-GSP L A	Steel Q355B acc. to GB/T 1591 hot dip galvanized	

Hilti MT frame trapezes with load introduction component

Product Description
 Dimensions and materials

Annex A9

Table A12: Dimensions and materials of Hilti adjustable angle brace MT-AB A set and MT-AB A OC set

Item number	Designation	Materials and coatings	Illustration (Dimensions in mm)
2346395	MT-AB A set	Steel Q235B acc. to GB/T700 galvanized	
2346396	MT-AB A OC set	Steel Q235B acc. to GB/T700 hot dip galvanized	
Additional components of MT-AB A set and MT-AB A OC set			
-	-	Bolt M10x65: strength class 8.8 acc. to ISO 898-1, hot dip galvanized	
		Flanged nut: strength class 8 acc. to ISO 898-2, galvanized with seal	
		Spacer Steel Q235B acc. to GB/T700 zinc coated	

Hilti MT frame trapezes with load introduction component

Product Description
 Dimensions and materials

Annex A10

Table A13: Dimensions and materials of Hilti threaded rods for use with Hilti frame trapezes of MT System

Item number	Designation	M thread	L [mm]	Materials	Illustration (Dimensions in mm)
339795	AM10x1000 4.8	M10	1000	Strength class 4.8 in accordance with DIN976-1, zinc coated	
339796	AM10x2000 4.8	M10	2000		
216418	AM10x3000 4.8	M10	3000		
339797	AM12x1000 4.8	M12	1000		
216420	AM12x2000 4.8	M12	2000		
216421	AM12x3000 4.8	M12	3000		
407497	AM 8.8 M10x1000	M10	1000	Strength class 8.8 in accordance with DIN976-1, zinc coated	
2008566	AM 8.8 M10x3000	M10	3000		
407498	AM 8.8 M12x1000	M12	1000		
2008567	AM 8.8 M12x3000	M12	3000		
58670	AM10x1000 A4-70	M10	1000	Strength class A4-70 in accordance with DIN976-1, Stainless steel	
58707	AM10x3000 A4-70	M10	3000		
58671	AM12x1000 A4-70	M12	1000		
58709	AM12x3000 A4-70	M12	3000		

Hilti MT frame trapezes with load introduction component

Product Description
 Dimensions and materials

Annex A11

Table A14: Dimensions and materials of Hilti hexagonal nuts for use with Hilti frame trapezes of MT System

Illustration (Dimensions in mm)	Item number	Designation	M thread	W [mm]	H [mm]	Material and coating
	216466	M10 hexagonal nut	M10	17	8	Strength class 8 in accordance with DIN 934, zinc coated
	2184554	M12 hexagonal nut	M12	19	10	
	2184474	M10 hexagonal nut	M10	17	8	Strength class 70 in accordance with DIN 934, stainless steel
	2184475	M12 hexagonal nut	M12	19	10	

Table A15: Geometry and dimensions of MQZ-L11 and MQZ-L13 drilled plates for use with Hilti trapeze frames of MT System

Item number	Designation	D [mm]	Materials	Illustration (Dimensions in mm)
2199455	MQZ-L11	11,5	S235JR in accordance with DIN EN 10025-2	
2199456	MQZ-L13	13,5		

Hilti MT frame trapezes with load introduction component

Product Description
 Dimensions and materials

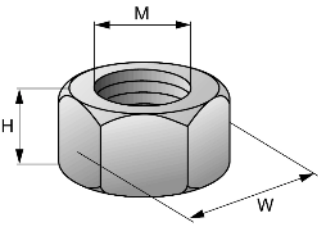
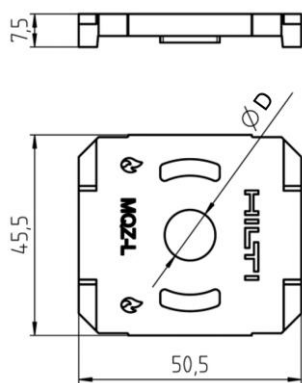
Annex A12

Specification of intended use

- Hilti frame trapezes of MT System are used to transfer building services component loads such as ducts and equipment for sprinklers, wafter, heating, cooling, ventilation, electrical and other systems in case of fire.
- Hilti frame trapezes of MT System are performing this loadbearing function under the conditions described in Section 2 of this European Technical Assessment.
- The resistance and deformation in case of fire are referring to the boundary conditions of the standard temperature / time curve (STTC) in accordance with EN 1363-1.
- The resistance of Hilti frame trapezes of MT System in case of fire applies for static and centric actions according to Annex C.
- Prior to installation, it has to be ensured that the component to be supported by the frame trapeze, the anchoring of the frame trapeze to the base material and the base material itself are suitable to withstand the resistance values given in Annex C in this European Technical Assessment in case of fire.
- MT-C-GS OC connector is made of zinc coated steel. Two leg angles are arranged at 90 ° between each other and with stiffening ribs. Various openings in different size and shape are located on the leg angles.
- MT-C-GSP L A OC connector is made of flat zinc coated steel in L-shape with 6 openings in total.
- MT-AB A set and MT-AB A OC set connectors are made of zinc coated steel. The connectors are in U-shape with two parallel flanges in trapezoid shape and in total with 5 openings.
- The Hilti channel connectors MT-TL M10 and MT-TL M10 OC, and MT-TFB OC are used to fix the channels to connectors or baseplates and transfer the loads. MT-TL M10 and MT-TL M10 OC channels connectors are used for open profile MT channels. MT-TFB OC thread forming bolts are used for closed profile MT channels.
- The Hilti channel connectors are suitable for undertaking this load-transferring function under the conditions described in Section 2 of this European Technical Assessment.
- The nuts MT-TL M10 and MT-TL M10 OC are connected to the installation channel according to the manufacturers instructions (see Figure A1) and the attached component by tightening an appropriate bolt acc. to Table A10 and A11. Installation torque for MT-TL M10 a is 30 Nm, for MT-TL M10 OC is 40 Nm (see Table B4).

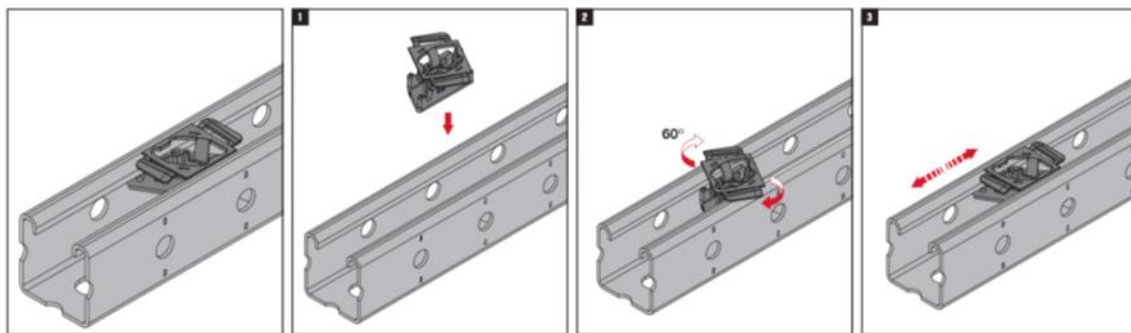

Figure A1: Installation instructions for Hilti channel connectors MT-TL M10 and MT-TL M10 OC

- The required torques may be applied with electrical or non-electrical devices. MT-TFB OC thread forming bolts is used to screw together installation channels and attached angle connectors or base connectors by screwing them together through the appropriate openings of these components. For the thread forming bolt MT-TFB OC a torque of 60 Nm applies.

<p>Hilti MT frame trapezes with load introduction component</p>	<p>Annex A13</p>
<p>Description of products for intended use</p>	

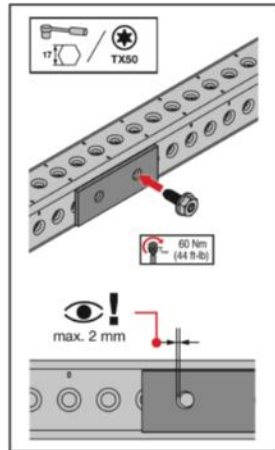
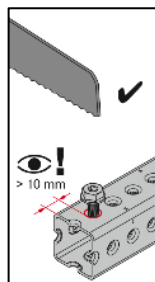
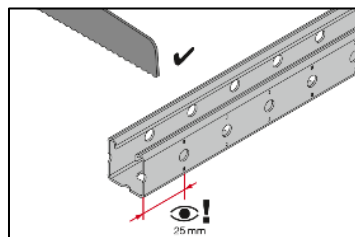

Figure A2: Installation instructions for Hilti MT-TFB OC thread forming bolts

- The MT installation open profile channels and closed profiles (girders) can be cut along the entire length following the manufacturers instructions without compromising the declared performances.
- Hilti Installation channels are used in combination with Hilti channel connectors and are cut to length centrally between the longholes or the roundholes at the installation channel marking.
- For girders the distance between the cut of the girder and start of the dome shaped hole has to be at a minimum distance of 10 mm.



- For channels the distance between the cut of the channel and center of the closest hole has to be at a minimum distance of 25 mm.



Hilti MT frame trapezes with load introduction component

Description of products for intended use

Annex A14

- The fastening of the base connector to the base material is made with appropriate anchors. The anchoring used with the base material must be suitable and have a fireproof certificate.
- The cross section and material properties of the channels are shown in Annex B3.
- The Hilti frame trapezes of MT System must be installed by appropriately qualified personnel and under the supervision of the site manager. The general installation instructions of the manufacturer apply.

Hilti MT frame trapezes with load introduction component

Description of products for intended use

Annex A15

Figure A3: Hilti frame trapeze of MT System with load introduction components, MT-50 and MT-40D channels

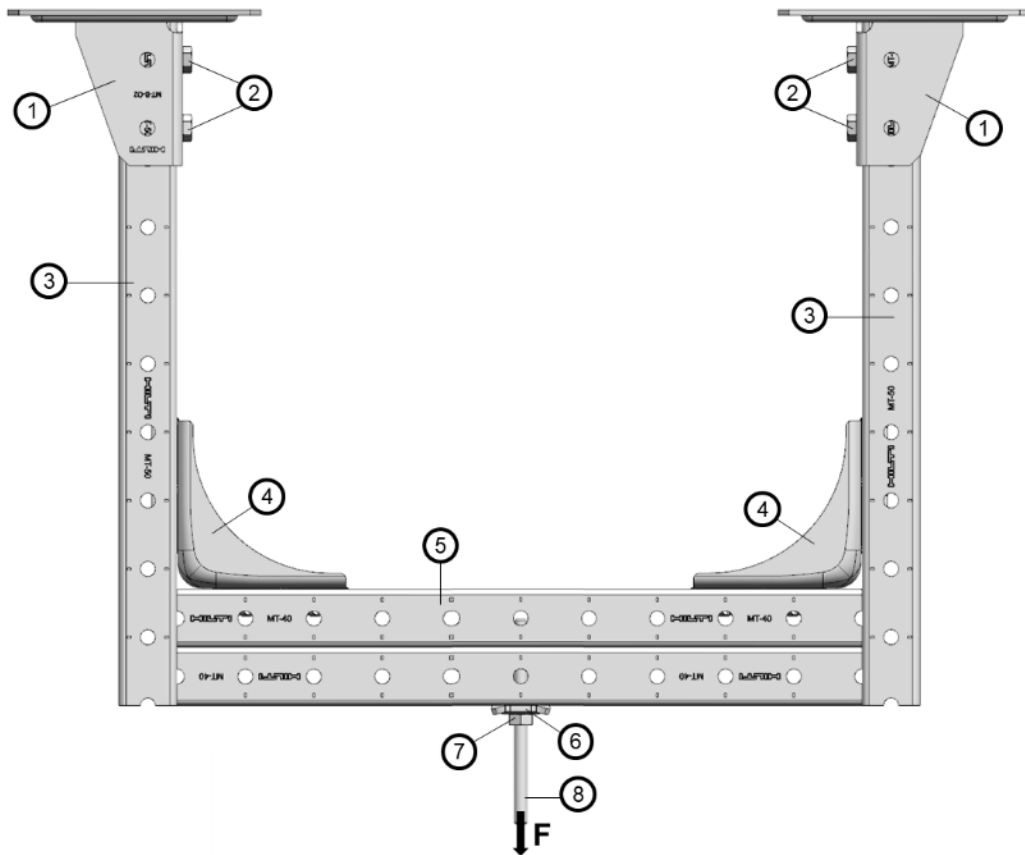

Legend

- 1 MT-B-O2, MT-B-O4, MT-B-T, or MT-AB A set baseplates
- 2 MT-TL M10 with MT-TLB channel connectors
- 3 MT-50
- 4 MT-C-GS OC
- 5 MT-40D
- 6 MQA-B saddle nut or threaded rod with MQZ-L drilled plates
- 7 hexagonal nut
- 8 Threaded rod
- F applied load

Annex

- Annex A5
- Annex A7 and A8
- Annex A1
- Annex A10
- Annex A1
- Annex A2, A3 and A13
- Annex A13
- Annex A12

Hilti MT frame trapezes with load introduction component

Description of products for intended use

Annex A16

Figure A4: Hilti frame trapeze of MT System with load introduction components, MT-50 and MT-50 channels

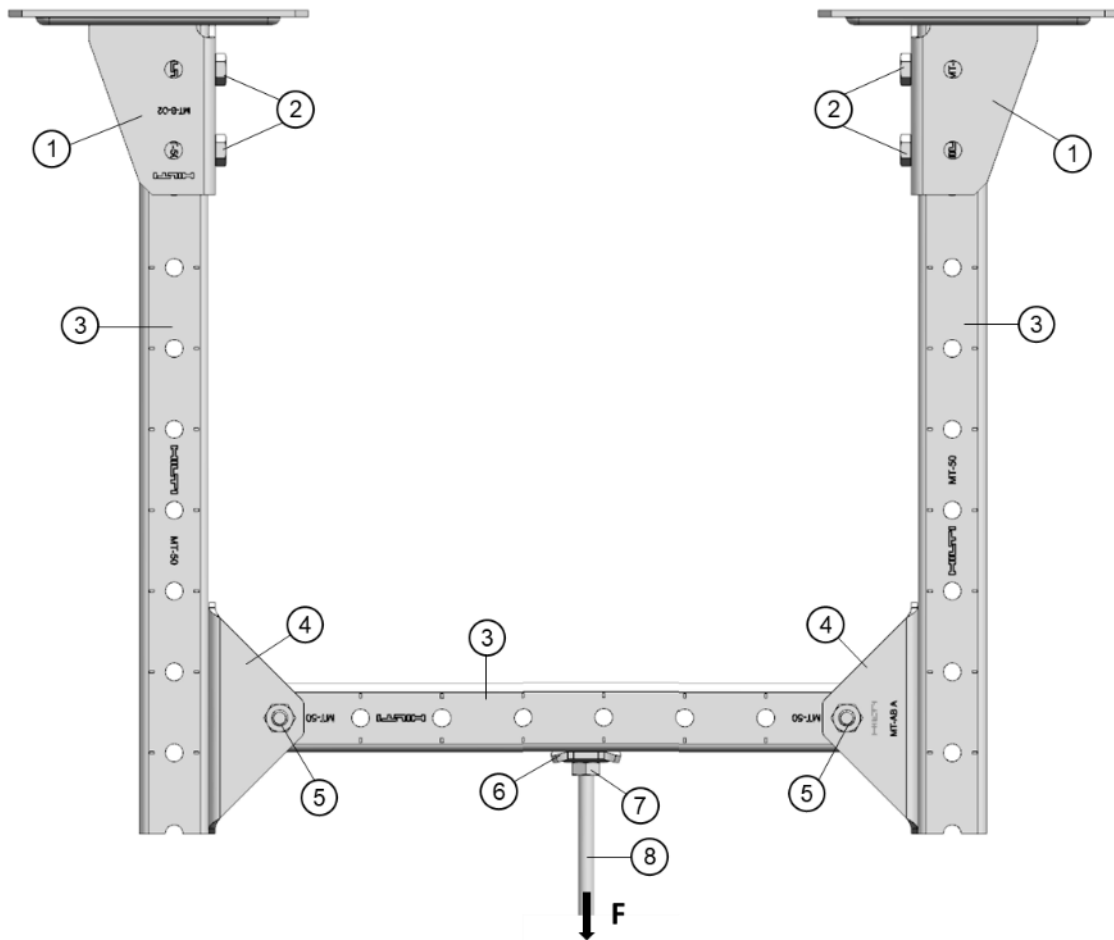

Legend

- 1 MT-B-O2, MT-B-O4, MT-B-T or MT-AB A set baseplates
- 2 MT-TL M10 with MT-TLB channel connectors
- 3 MT-50
- 4 MT-AB A set
- 5 M10 8.8 bolt with M10 hexagonal nut as part of MT-AB A set
- 6 MQA-B saddle nut
- 7 hexagonal nut
- 8 Threaded rod
- F applied load

Annex

- Annex A5
- Annex A7 and A8
- Annex A1
- Annex A11
- Annex A11
- Annex A2, A3 and A13
- Annex A13
- Annex A12

Hilti MT frame trapezes with load introduction component

Description of products for intended use

Annex A17

Figure A5: Hilti frame trapeze of MT System with load introduction components, closed profiles

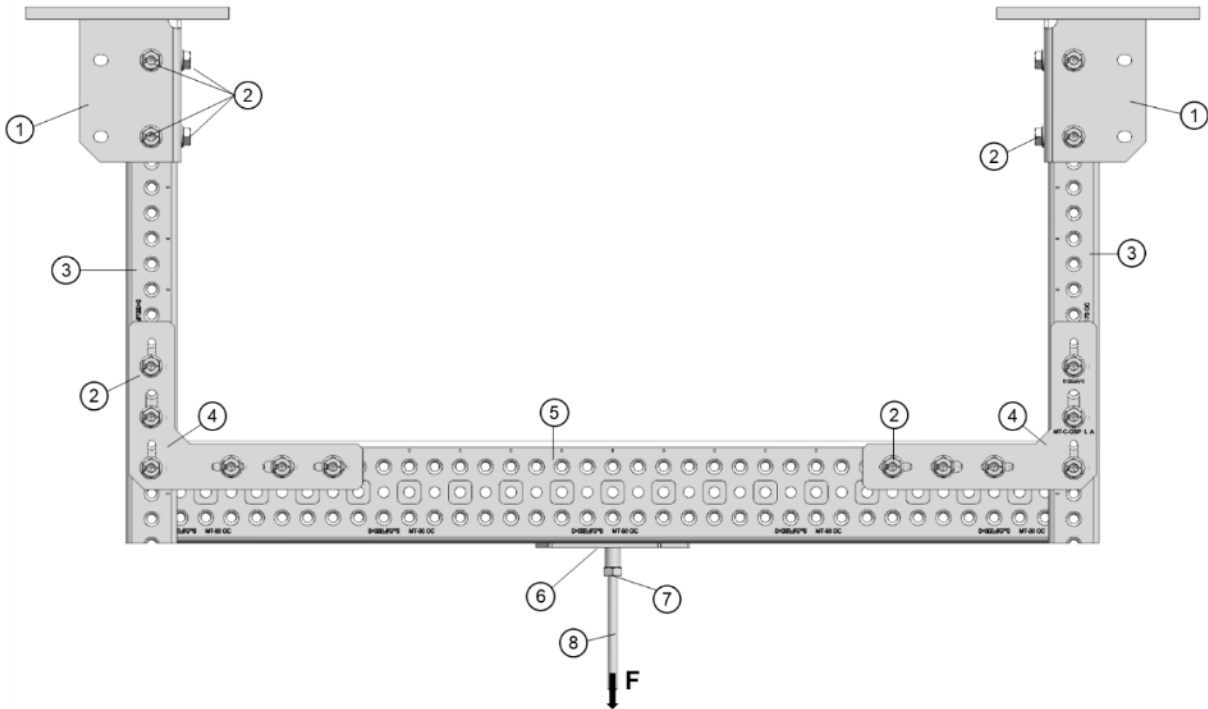

Legend

- 1 MT-B-GS T OC or MT-B-GS O4U OC
- 2 MT-TFB
- 3 MT-70
- 4 MT-C-GSP L A OC
- 5 MT-70 OC or MT-80 OC
- 6 MT-PCC-G
- 7 hexagonal nut
- 8 Threaded rod
- F applied load

Annex

- Annex A6
- Annex A7
- Annex A1
- Annex A10
- Annex A1
- Annex A5
- Annex A13
- Annex A12

Hilti MT frame trapezes with load introduction component

Description of products for intended use

Annex A18

Table B1: Installation torque of MT-TLB bolt in combination with MT-TL M10 and MT-TL M10 OC

Item number	Designation	Installation torque	Illustration									
2272080	MT-TL M10	30 Nm	 <table border="1" data-bbox="986 548 1342 683"> <thead> <tr> <th>t</th> <th>MT-TLB</th> <th>L</th> </tr> </thead> <tbody> <tr> <td>3 - 6 mm</td> <td>MT-TLB</td> <td>24 mm</td> </tr> <tr> <td>6 - 8 mm</td> <td>MT-TLB 30</td> <td>30 mm</td> </tr> </tbody> </table>	t	MT-TLB	L	3 - 6 mm	MT-TLB	24 mm	6 - 8 mm	MT-TLB 30	30 mm
t	MT-TLB	L										
3 - 6 mm	MT-TLB	24 mm										
6 - 8 mm	MT-TLB 30	30 mm										
2272082	MT-TL M10 OC	40 Nm										

Table B2: Installation torque of MT-TFB OC thread forming bolt combination with MT-70 and MT-80 installation channel families



Item number	Designation	Installation torque	Illustration
2272084	MT-TFB OC	60 Nm	

Hilti MT-TL and M channel connectors for use with MT frame trapezes

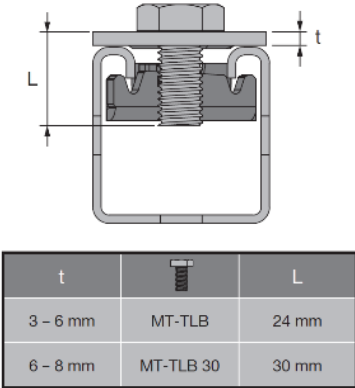
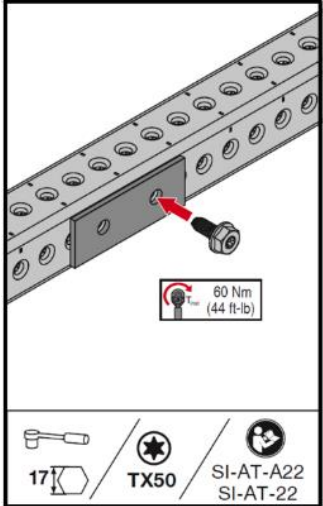
Requirements for performance assessment

Annex B1

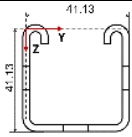
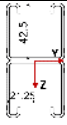
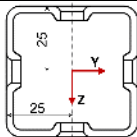
Table B3: Properties of the cross section of Hilti channels MT-50 S, MT-50 S OC, MT-50, MT-50 OC, MT-60 S, MT-60 S OC, MT-60, MT-60 OC, MT-70 S OC, MT-70 OC, MT-80 S OC and MT-80 OC

Description	Symbol	Unit	MT-50 S / MT-50 / MT-50 U / MT-50 S OC / MT-50 OC	MT-40D S / MT-40D / MT-40D S OC / MT-40D OC	MT-70 S OC / MT-70 OC	MT-80 S OC / MT-80 OC
Cross section (dimensions in mm)	-	-				
Classification cross section in accordance with EN 1993-1-1	-	-	3	3	3	3
Cross section areas	A	cm ²	2.77	4.31	4.32	5.96
	A _{tot}	cm ²	2.77	4.31	4.32	5.96
Shear areas	A _y	cm ²	NPA	NPA	NPA	NPA
	A _z	cm ²	NPA	NPA	NPA	NPA
Centroid position	y _{C,0}	cm	1.99	0.00	0.00	0.00
	z _{C,0}	cm	2.07	0.00	0.00	0.00
Moments of inertia	I _y	cm ⁴	7.07	30.13	15.96	88.39
	I _z	cm ⁴	8.30	13.22	15.96	24.61
Polar moments of inertia	I _p	cm ⁴	15.36	43.35	31.93	113.00
	I _{p,M}	cm ⁴	66.91	43.35	31.93	113.00
Radii of gyration	i _y	cm	1.60	2.64	1.92	3.85
	i _z	cm	1.73	1.75	1.92	2.03
Polar radii of gyration	i _p	cm	2.35	3.17	2.72	4.36
	i _{p,M}	cm	4.91	3.17	2.72	4.36
Warping radius of gyration	i _{ω,M}	cm	NPA	NPA	NPA	NPA
Torsional constant	J	cm ⁴	NPA	NPA	NPA	NPA
Secondary torsional constant	J _s	cm ⁴	NPA	NPA	NPA	NPA
Location of the shear center	y _{M,0}	cm	NPA	NPA	NPA	NPA
	z _{M,0}	cm	NPA	NPA	NPA	NPA
	y _M	cm	NPA	NPA	NPA	NPA
	z _M	cm	NPA	NPA	NPA	NPA
Warping constants	I _{ω,C}	cm ⁶	NPA	NPA	NPA	NPA
	I _{ω,M}	cm ⁶	NPA	NPA	NPA	NPA
Section moduli	S _{y,max}	cm ³	3.46	7.09	6.39	17.68
	S _{y,min}	cm ³	-3.21	-7.09	-6.39	-17.68
	S _{z,max}	cm ³	3.90	6.22	6.39	9.84
	S _{z,min}	cm ³	-3.90	-6.22	-6.39	-9.84
Torsional section modulus	S _t	cm ³	NPA	NPA	NPA	NPA
Max. plastic bending moment	M _{pl,y,k}	kNm	NPA	NPA	NPA	NPA
	M _{pl,z,k}	kNm	NPA	NPA	NPA	NPA
Max. plastic section moduli	Z _y	cm ³	NPA	NPA	NPA	NPA
	Z _z	cm ³	NPA	NPA	NPA	NPA
Plastic shear areas	A _{pl,y}	cm ²	NPA	NPA	NPA	NPA
	A _{pl,z}	cm ²	NPA	NPA	NPA	NPA
Area bisecting axis position	f _{y,0}	cm	NPA	NPA	NPA	NPA
	f _{z,0}	cm	NPA	NPA	NPA	NPA
Plastic shear forces	V _{pl,y,k}	kN	NPA	NPA	NPA	NPA
	V _{pl,z,k}	kN	NPA	NPA	NPA	NPA
Plastic axial forces	N _{pl,k}	kN	NPA	NPA	NPA	NPA
Buckling curves	BC _y	-	c	c	c	c
	BC _z	-	c	c	c	c

Properties of Hilti MT-50, MT-40D, MT-70 and MT-80 channel cross sections

Requirements for performance assessment

Annex B2

Figure C1: Definition of Hilti MT-B-GS T OC and MT-B-GS O4U OC baseplate local coordinate System for use with Hilti MT-70 S OC, MT-70 OC, MT-80 S OC and MT-80 OC installation channels

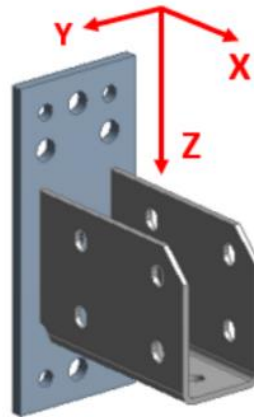

Table C2: Resistance $F_{Rk,t}$ and $M_{Rk,t}$ in case of fire after $t = 30, 60, 90$ and 120 minutes of Hilti MT-B-GS T OC and MT-B-GS O4U OC baseplate in combination with Hilti MT-70 S OC, MT-70 OC, MT-80 S OC and MT-80 OC installation channels

t	$+F_{x,Rk,t}$	$-F_{x,Rk,t}$	$+F_{y,Rk,t}$	$-F_{y,Rk,t}$	$+F_{z,Rk,t}$	$-F_{z,Rk,t}$	$+M_{x,Rk,t}$	$-M_{x,Rk,t}$	$+M_{y,Rk,t}$	$-M_{y,Rk,t}$	$+M_{z,Rk,t}$	$-M_{z,Rk,t}$
min	N	N	N	N	N	N	Nm	Nm	Nm	Nm	Nm	Nm
30	3500,0	NPA	3600,0	3600,0	3600,0	3600,0	NPA	NPA	421,9	421,9	421,9	421,9
60	3500,0		2786,9	2786,9	2786,9	2786,9			337,5	337,5	337,5	337,5
90	3500,0		2500,0	2500,0	2250,0	2500,0			337,5	337,5	337,5	337,5
120	3500,0		2500,0	2500,0	2250,0	2500,0			337,5	337,5	337,5	337,5

Characteristic resistance of Hilti MT-B-GS T OC baseplate in case of fire

Characteristic resistance of Hilti frame trapeze in case of fire

Annex C1

Figure C25: Definition of Hilti MT-AB A set and MT-AB A OC set local coordinate System for use with Hilti MT-50 S, MT-50, MT-50 S OC and MT-50 OC installation channels

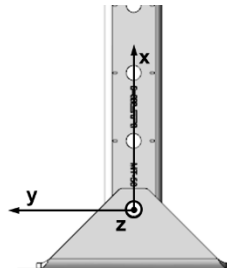

Table C3: Resistance $F_{Rk,t}$ and $M_{Rk,t}$ in case of fire after $t = 30, 60, 90$ and 120 minutes of Hilti MT-AB A and MT-AB A OC angel brace as baseplate application in combination with Hilti MT-50 S, MT-50, MT-50 S OC and MT-50 OC installation channels

t	$+F_{x,Rk,t}$	$-F_{x,Rk,t}$	$+F_{y,Rk,t}$	$-F_{y,Rk,t}$	$+F_{z,Rk,t}$	$-F_{z,Rk,t}$	$+M_{x,Rk,t}$	$-M_{x,Rk,t}$	$+M_{y,Rk,t}$	$-M_{y,Rk,t}$	$+M_{z,Rk,t}$	$-M_{z,Rk,t}$
min	N	N	N	N	N	N	Nm	Nm	Nm	Nm	Nm	Nm
30	3600,0	NPA	3165,1	3165,1	NPA	NPA	NPA	NPA	NPA	NPA	NPA	NPA
60	2302,5		1627,8	1627,8								
90	1804,0		1115,4	1115,4								
120	1554,8		859,1	859,1								

Figure C3: Definition of Hilti MT-B O2, MT-B O2 OC, MT-B O4, MT-B O4 OC, MT-B O2B and MT-B O2B OC baseplate local coordinate System for use with Hilti MT-50 S, MT-50, MT-50 S OC and MT-50 OC installation channels

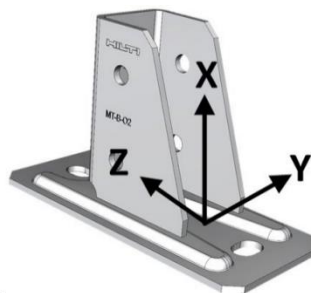

Table C4: Resistance $F_{Rk,t}$ and $M_{Rk,t}$ in case of fire after $t = 30, 60, 90$ and 120 minutes of Hilti MT-B O2, MT-B O2 OC, MT-B O4, MT-B O4 OC, MT-B O2B and MT-B O2B OC baseplate in combination with Hilti MT-50 S, MT-50, MT-50 S OC and MT-50 OC installation channels

t	$+F_{x,Rk,t}$	$-F_{x,Rk,t}$	$+F_{y,Rk,t}$	$-F_{y,Rk,t}$	$+F_{z,Rk,t}$	$-F_{z,Rk,t}$	$+M_{x,Rk,t}$	$-M_{x,Rk,t}$	$+M_{y,Rk,t}$	$-M_{y,Rk,t}$	$+M_{z,Rk,t}$	$-M_{z,Rk,t}$
min	N	N	N	N	N	N	Nm	Nm	Nm	Nm	Nm	Nm
30	2250,0	NPA	1338,0	1338,0	1216,8	1338,0	NPA	NPA	134,0	134,0	134,0	134,0
60	1000,0		793,3	793,3	450,0	793,3			64,6	64,6	64,6	64,6
90	1000,0		611,7	611,7	450,0	611,7			64,6	64,6	64,6	64,6
120	1000,0		521,0	521,0	450,0	521,0			64,6	64,6	64,6	64,6

Characteristic resistance of Hilti MT-AB A set and MT-B-O2baseplate in case of fire

Characteristic resistance of Hilti frame trapeze in case of fire

Annex C2

Figure C4: Definition of Hilti MT-B T and MT-B T OC baseplate local coordinate System for use with Hilti MT-50 S, MT-50, MT-50 S OC and MT-50 OC installation channels

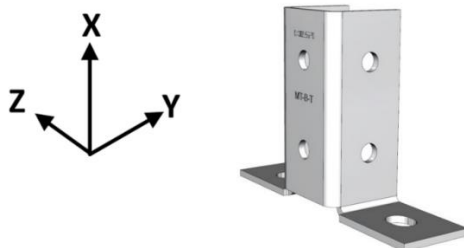

Table C5: Resistance $F_{Rk,t}$ and $M_{Rk,t}$ in case of fire after $t = 30, 60, 90$ and 120 minutes of Hilti MT-B T and MT-B T OC, baseplate in combination with Hilti MT-50 S, MT-50, MT-50 S OC and MT-50 OC installation channels

t	$+F_{x,Rk,t}$	$-F_{x,Rk,t}$	$+F_{y,Rk,t}$	$-F_{y,Rk,t}$	$+F_{z,Rk,t}$	$-F_{z,Rk,t}$	$+M_{x,Rk,t}$	$-M_{x,Rk,t}$	$+M_{y,Rk,t}$	$-M_{y,Rk,t}$	$+M_{z,Rk,t}$	$-M_{z,Rk,t}$
min	N	N	N	N	N	N	Nm	Nm	Nm	Nm	Nm	Nm
30	1160,5	NPA	1232,2	1232,2	NPA	NPA	NPA	NPA	NPA	NPA	84,4	84,4
60	623,0		756,3	756,3							0,0	0,0
90	500,0		597,6	597,6							0,0	0,0
120	500,0		518,3	518,3							0,0	0,0

Characteristic resistance of Hilti MT-B-T baseplate in case of fire

Characteristic resistance of Hilti frame trapeze in case of fire

Annex C3

Figure C5: Definition of Hilti MT-C-GSP L A OC connector local coordinate System and viewpoints for use with Hilti MT-70 S OC, MT-70 OC, MT-80 S OC and MT-80 OC installation channels

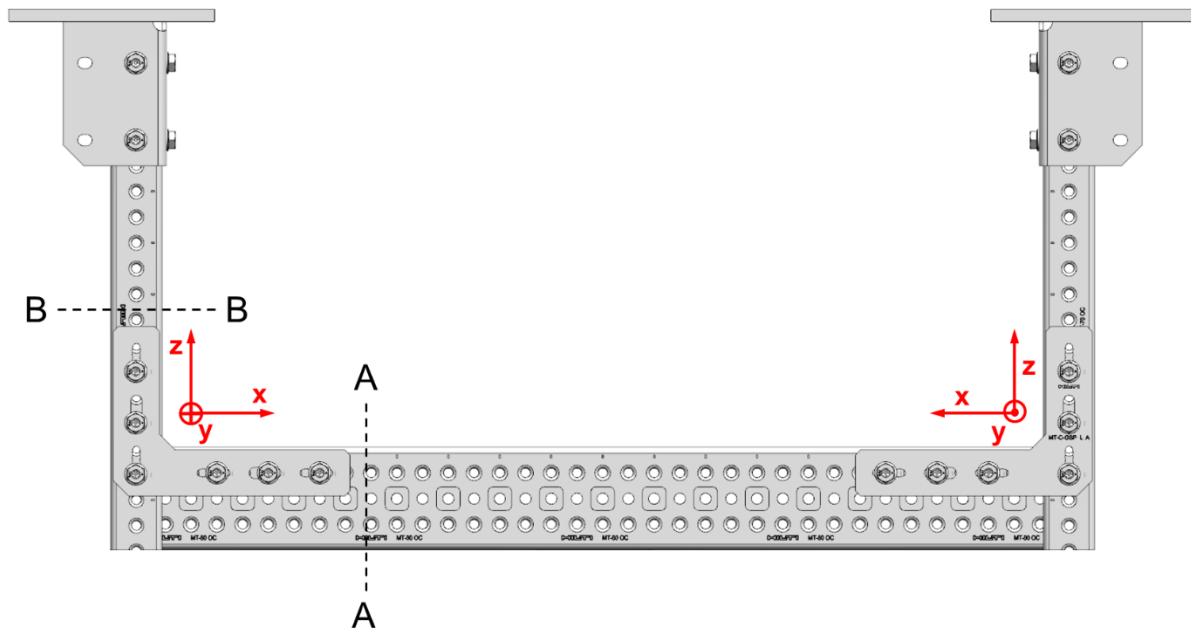

Table C6: Resistance $F_{Rk,t}$ and $M_{Rk,t}$ in case of fire after $t = 30, 60, 90$ and 120 minutes of Hilti MT-C-GSP L A OC connector in combination with Hilti MT-70 S OC and MT-70 OC installation channels, view A-A

t	+ $F_{x,Rk,t}$	- $F_{x,Rk,t}$	+ $F_{y,Rk,t}$	- $F_{y,Rk,t}$	+ $F_{z,Rk,t}$	- $F_{z,Rk,t}$	+ $M_{x,Rk,t}$	- $M_{x,Rk,t}$	+ $M_{y,Rk,t}$	- $M_{y,Rk,t}$	+ $M_{z,Rk,t}$	- $M_{z,Rk,t}$
min	N	N	N	N	N	N	Nm	Nm	Nm	Nm	Nm	Nm
30	3200	NPA	NPA	NPA	NPA	2000	NPA	NPA	140	NPA	NPA	NPA
60	3200					2000			140			
90	3200					2000			140			
120	3200					2000			140			

Table C7: Resistance $F_{Rk,t}$ and $M_{Rk,t}$ in case of fire after $t = 30, 60, 90$ and 120 minutes of Hilti MT-C-GSP L A OC connector in combination with Hilti MT-70 S OC and MT-70 OC installation channels, view B-B

t	+ $F_{x,Rk,t}$	- $F_{x,Rk,t}$	+ $F_{y,Rk,t}$	- $F_{y,Rk,t}$	+ $F_{z,Rk,t}$	- $F_{z,Rk,t}$	+ $M_{x,Rk,t}$	- $M_{x,Rk,t}$	+ $M_{y,Rk,t}$	- $M_{y,Rk,t}$	+ $M_{z,Rk,t}$	- $M_{z,Rk,t}$
min	N	N	N	N	N	N	Nm	Nm	Nm	Nm	Nm	Nm
30	NPA	3000	NPA	NPA	3200	NPA	NPA	NPA	NPA	140	NPA	NPA
60		3000			3200					140		
90		3000			3200					140		
120		3000			3200					140		

Characteristic resistance of Hilti MT-C-GSP L A OC connector in case of fire

Characteristic resistance of Hilti frame trapeze in case of fire

Annex C4

Table C8: Resistance $F_{Rk,t}$ and $M_{Rk,t}$ in case of fire after $t = 30, 60, 90$ and 120 minutes of Hilti MT-C-GSP L A OC connector in combination with Hilti MT-70 S OC, MT-70 OC and MT-80 C OC and MT-80 OC installation channels, view A-A

t	$+F_{x,Rk,t}$	$-F_{x,Rk,t}$	$+F_{y,Rk,t}$	$-F_{y,Rk,t}$	$+F_{z,Rk,t}$	$-F_{z,Rk,t}$	$+M_{x,Rk,t}$	$-M_{x,Rk,t}$	$+M_{y,Rk,t}$	$-M_{y,Rk,t}$	$+M_{z,Rk,t}$	$-M_{z,Rk,t}$
min	N	N	N	N	N	N	Nm	Nm	Nm	Nm	Nm	Nm
30	3200	NPA	NPA	NPA	NPA	1500	NPA	NPA	140	NPA	NPA	NPA
60	3200					1500			140			
90	3200					1500			140			
120	3200					1500			140			

Table C9: Resistance $F_{Rk,t}$ and $M_{Rk,t}$ in case of fire after $t = 30, 60, 90$ and 120 minutes of Hilti MT-C-GSP L A OC connector in combination with Hilti MT-70 S OC, MT-70 OC and MT-80 C OC and MT-80 OC installation channels, view B-B

t	$+F_{x,Rk,t}$	$-F_{x,Rk,t}$	$+F_{y,Rk,t}$	$-F_{y,Rk,t}$	$+F_{z,Rk,t}$	$-F_{z,Rk,t}$	$+M_{x,Rk,t}$	$-M_{x,Rk,t}$	$+M_{y,Rk,t}$	$-M_{y,Rk,t}$	$+M_{z,Rk,t}$	$-M_{z,Rk,t}$
min	N	N	N	N	N	N	Nm	Nm	Nm	Nm	Nm	Nm
30	NPA	1500	NPA	NPA	2900	NPA	NPA	NPA	NPA	140	NPA	NPA
60		1500			2900					140		
90		1500			2900					140		
120		1500			2900					140		

Characteristic resistance of Hilti MT-C-GSP L A OC connector in case of fire

Characteristic resistance of Hilti frame trapeze in case of fire

Annex C5

Figure C6: Definition of Hilti MT-AB A set and MT-AB A OC set local coordinate System and viewpoints for use with Hilti MT-50 S, MT-50, MT-50 S OC and MT-50 OC installation channels

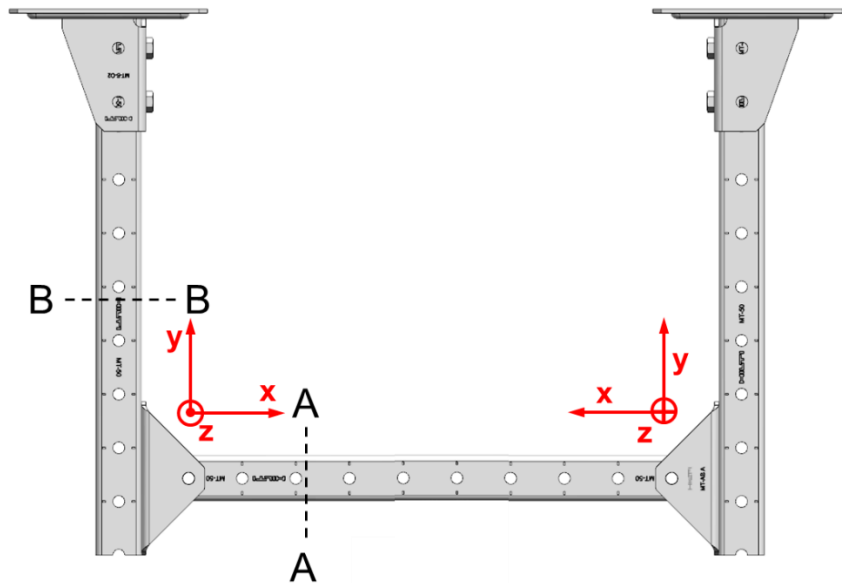

Table C10: Resistance $F_{Rk,t}$ and $M_{Rk,t}$ in case of fire after $t = 30, 60, 90$ and 120 minutes of Hilti MT-AB A set and MT-AB A OC set angle brace used as connector in combination with Hilti MT-50 S, MT-50, MT-50 S OC and MT-50 OC installation channels, view A-A

t	+ $F_{x,Rk,t}$	- $F_{x,Rk,t}$	+ $F_{y,Rk,t}$	- $F_{y,Rk,t}$	+ $F_{z,Rk,t}$	- $F_{z,Rk,t}$	+ $M_{x,Rk,t}$	- $M_{x,Rk,t}$	+ $M_{y,Rk,t}$	- $M_{y,Rk,t}$	+ $M_{z,Rk,t}$	- $M_{z,Rk,t}$
min	N	N	N	N	N	N	Nm	Nm	Nm	Nm	Nm	Nm
30	1566,1	NPA	NPA	1750,0	NPA	NPA	NPA	NPA	NPA	NPA	NPA	NPA
60	808,1			926,1								
90	555,5			647,3								
120	429,2			507,9								

Table C11: Resistance $F_{Rk,t}$ and $M_{Rk,t}$ in case of fire after $t = 30, 60, 90$ and 120 minutes of Hilti MT-AB A set and MT-AB A OC set angle brace used as connector in combination with Hilti MT-50 S, MT-50, MT-50 S OC and MT-50 OC installation channels, view B-B

t	+ $F_{x,Rk,t}$	- $F_{x,Rk,t}$	+ $F_{y,Rk,t}$	- $F_{y,Rk,t}$	+ $F_{z,Rk,t}$	- $F_{z,Rk,t}$	+ $M_{x,Rk,t}$	- $M_{x,Rk,t}$	+ $M_{y,Rk,t}$	- $M_{y,Rk,t}$	+ $M_{z,Rk,t}$	- $M_{z,Rk,t}$
min	N	N	N	N	N	N	Nm	Nm	Nm	Nm	Nm	Nm
30	NPA	1566,1	1750,0	NPA	NPA	NPA	NPA	NPA	NPA	NPA	NPA	NPA
60		808,1	926,1									
90		555,5	647,3									
120		429,2	507,9									

Characteristic resistance of Hilti MT-AB A set angle brace in case of fire

Characteristic resistance of Hilti frame trapeze in case of fire

Annex C6

Figure C7: Definition of Hilti MT-C-GS OC connector local coordinate System and viewpoints for use with vertical Hilti MT-50 S, MT-50, MT-50 S OC or MT-50 OC and horizontal MT-50 S, MT-50, MT-50 S OC, MT-50 OC, MT-40D S, MT-40D, MT-40D S OC or MT-40D OC installation channels

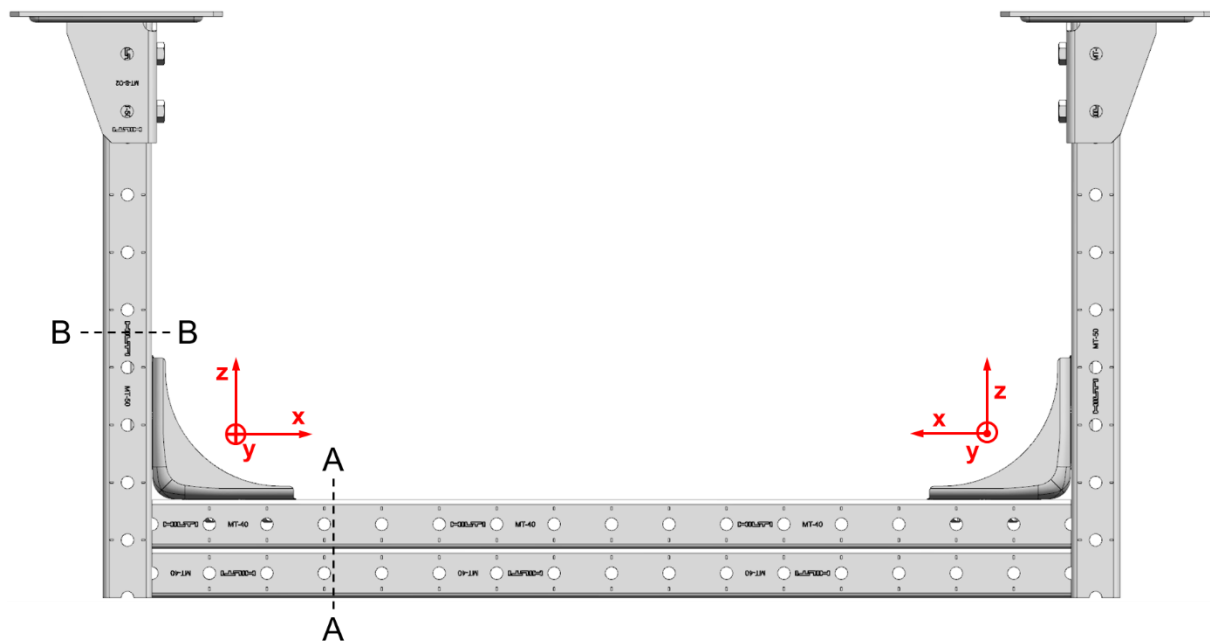

Table C12: Resistance $F_{Rk,t}$ and $M_{Rk,t}$ in case of fire after $t = 30, 60, 90$ and 120 minutes of Hilti MT-C-GS OC connector for use with vertical Hilti MT-50 S, MT-50, MT-50 S OC or MT-50 OC and horizontal MT-50 S, MT-50, MT-50 S OC, MT-50 OC, MT-40D S, MT-40D, MT-40D S OC or MT-40D OC installation channels, view A-A

t	+ $F_{x,Rk,t}$	- $F_{x,Rk,t}$	+ $F_{y,Rk,t}$	- $F_{y,Rk,t}$	+ $F_{z,Rk,t}$	- $F_{z,Rk,t}$	+ $M_{x,Rk,t}$	- $M_{x,Rk,t}$	+ $M_{y,Rk,t}$	- $M_{y,Rk,t}$	+ $M_{z,Rk,t}$	- $M_{z,Rk,t}$
min	N	N	N	N	N	N	Nm	Nm	Nm	Nm	Nm	Nm
30	935,5	NPA	NPA	NPA	NPA	782,3	NPA	NPA	216,0	NPA	NPA	NPA
60	615,9					559,8			137,7			
90	509,3					485,6			111,6			
120	456,1					448,6			98,6			

Table C13: Resistance $F_{Rk,t}$ and $M_{Rk,t}$ in case of fire after $t = 30, 60, 90$ and 120 minutes of Hilti MT-C-GS OC connector for use with vertical Hilti MT-50 S, MT-50, MT-50 S OC or MT-50 OC and horizontal MT-50 S, MT-50, MT-50 S OC, MT-50 OC, MT-40D S, MT-40D, MT-40D S OC or MT-40D OC installation channels, view B-B

t	+ $F_{x,Rk,t}$	- $F_{x,Rk,t}$	+ $F_{y,Rk,t}$	- $F_{y,Rk,t}$	+ $F_{z,Rk,t}$	- $F_{z,Rk,t}$	+ $M_{x,Rk,t}$	- $M_{x,Rk,t}$	+ $M_{y,Rk,t}$	- $M_{y,Rk,t}$	+ $M_{z,Rk,t}$	- $M_{z,Rk,t}$
min	N	N	N	N	N	N	Nm	Nm	Nm	Nm	Nm	Nm
30	NPA	689,6	NPA	NPA	935,5	NPA	NPA	NPA	NPA	NPA	216,0	NPA
60		300,0			615,9						137,7	
90		300,0			509,3						111,6	
120		300,0			456,1						98,6	

Characteristic resistance of Hilti MT-C-GS connector in case of fire

Characteristic resistance of Hilti frame trapeze in case of fire

Annex C7

Figure C8: Definition of Hilti MT-C-GS OC connector local coordinate System and viewpoints for use with vertical Hilti MT-50 S, MT-50, MT-50 S OC or MT-50 OC and horizontal MT-40D S, MT-40D, MT-40D S OC or MT-40D OC installation channels

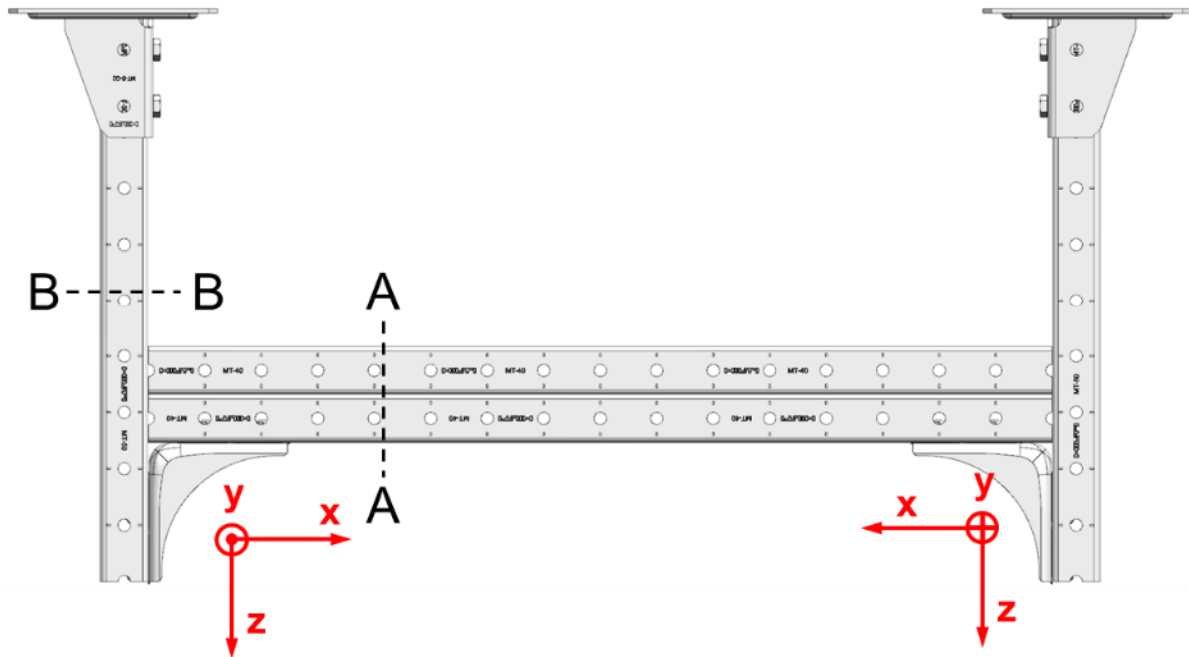

Table C14: Resistance $F_{Rk,t}$ and $M_{Rk,t}$ in case of fire after $t = 30, 60, 90$ and 120 minutes of Hilti MT-C-GS OC connector for use with vertical Hilti MT-50 S, MT-50, MT-50 S OC or MT-50 OC and horizontal MT-40D S, MT-40D, MT-40D S OC or MT-40D OC installation channels, view A-A

t	+ $F_{x,Rk,t}$	- $F_{x,Rk,t}$	+ $F_{y,Rk,t}$	- $F_{y,Rk,t}$	+ $F_{z,Rk,t}$	- $F_{z,Rk,t}$	+ $M_{x,Rk,t}$	- $M_{x,Rk,t}$	+ $M_{y,Rk,t}$	- $M_{y,Rk,t}$	+ $M_{z,Rk,t}$	- $M_{z,Rk,t}$	
min	N	N	N	N	N	N	Nm	Nm	Nm	Nm	Nm	Nm	
30	426,1	NPA	NPA	NPA	877,4	NPA	NPA	NPA	NPA	NPA	125,0	NPA	NPA
60	300,0				580,1						0,0		
90	300,0				481,0						0,0		
120	300,0				431,4						0,0		

Table C15: Resistance $F_{Rk,t}$ and $M_{Rk,t}$ in case of fire after $t = 30, 60, 90$ and 120 minutes of Hilti MT-C-GS OC connector for use with vertical Hilti MT-50 S, MT-50, MT-50 S OC or MT-50 OC and horizontal MT-40D S, MT-40D, MT-40D S OC or MT-40D OC installation channels, view B-B

t	+ $F_{x,Rk,t}$	- $F_{x,Rk,t}$	+ $F_{y,Rk,t}$	- $F_{y,Rk,t}$	+ $F_{z,Rk,t}$	- $F_{z,Rk,t}$	+ $M_{x,Rk,t}$	- $M_{x,Rk,t}$	+ $M_{y,Rk,t}$	- $M_{y,Rk,t}$	+ $M_{z,Rk,t}$	- $M_{z,Rk,t}$	
min	N	N	N	N	N	N	Nm	Nm	Nm	Nm	Nm	Nm	
30	NPA	689,6	NPA	NPA	NPA	1025,1	NPA	NPA	NPA	NPA	125,0	NPA	NPA
60		300,0				553,8					0,0		
90		300,0				396,7					0,0		
120		300,0				318,1					0,0		

Characteristic resistance of Hilti MT-C-GS connector in case of fire

Characteristic resistance of Hilti frame trapeze in case of fire

Annex C8

Figure C9: Definition of Hilti MT-C-GS OC connector local coordinate System and viewpoints for use with Hilti MT-50 S, MT-50, MT-50 S OC and MT-50 OC, installation channels

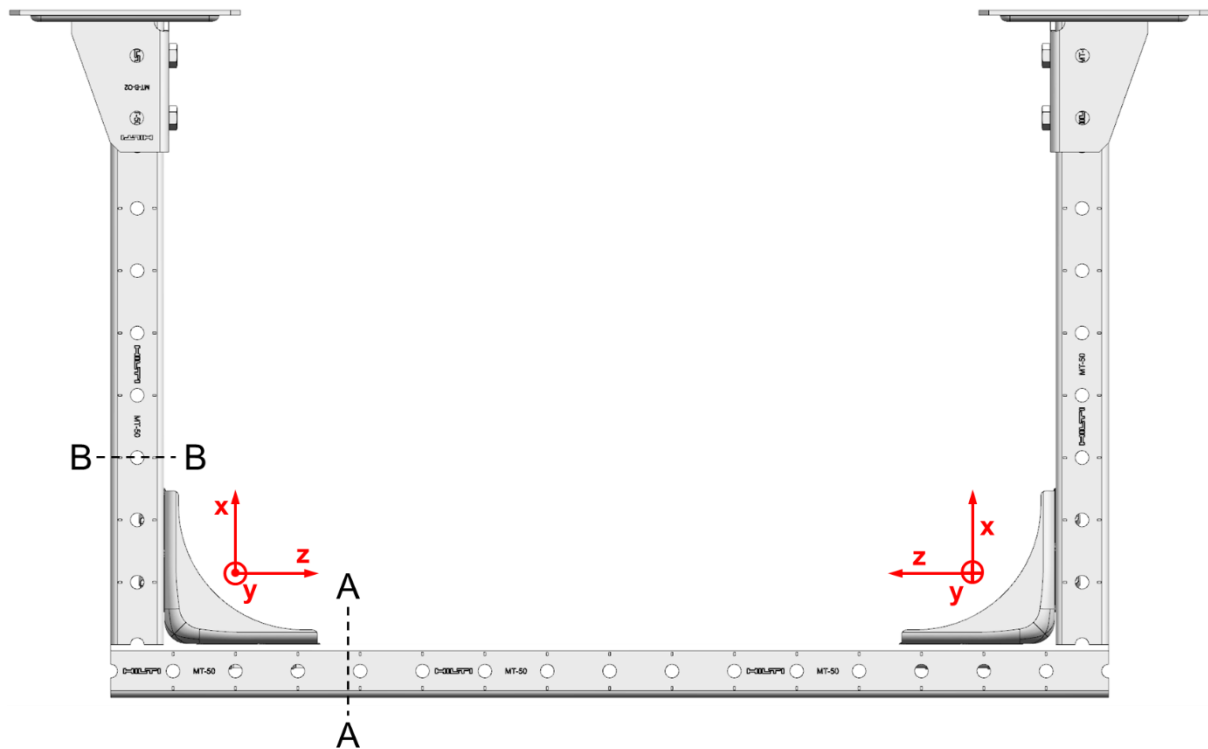

Table C16: Resistance $F_{Rk,t}$ and $M_{Rk,t}$ in case of fire after $t = 30, 60, 90$ and 120 minutes of Hilti MT-C-GS OC connector in combination with Hilti MT-50 S, MT-50, MT-50 S OC and MT-50 OC installation channels, view A-A

t	+ $F_{x,Rk,t}$	- $F_{x,Rk,t}$	+ $F_{y,Rk,t}$	- $F_{y,Rk,t}$	+ $F_{z,Rk,t}$	- $F_{z,Rk,t}$	+ $M_{x,Rk,t}$	- $M_{x,Rk,t}$	+ $M_{y,Rk,t}$	- $M_{y,Rk,t}$	+ $M_{z,Rk,t}$	- $M_{z,Rk,t}$
min	N	N	N	N	N	N	Nm	Nm	Nm	Nm	Nm	Nm
30	NPA	782,3	NPA	NPA	935,5	NPA	NPA	NPA	NPA	132,1	NPA	NPA
60		559,8			615,9					122,6		
90		485,6			509,3					0,0		
120		448,6			456,1					0,0		

Table C17: Resistance $F_{Rk,t}$ and $M_{Rk,t}$ in case of fire after $t = 30, 60, 90$ and 120 minutes of Hilti MT-C-GS OC connector in combination with Hilti MT-50 S, MT-50, MT-50 S OC and MT-50 OC installation channels, view B-B

t	+ $F_{x,Rk,t}$	- $F_{x,Rk,t}$	+ $F_{y,Rk,t}$	- $F_{y,Rk,t}$	+ $F_{z,Rk,t}$	- $F_{z,Rk,t}$	+ $M_{x,Rk,t}$	- $M_{x,Rk,t}$	+ $M_{y,Rk,t}$	- $M_{y,Rk,t}$	+ $M_{z,Rk,t}$	- $M_{z,Rk,t}$
min	N	N	N	N	N	N	Nm	Nm	Nm	Nm	Nm	Nm
30	935,5	NPA	NPA	NPA	NPA	782,3	NPA	NPA	132,1	NPA	NPA	NPA
60	615,9					559,8			122,6			
90	509,3					485,6			0,0			
120	456,1					448,6			0,0			

Characteristic resistance of Hilti MT-C-GS connector in case of fire

Characteristic resistance of Hilti frame trapeze in case of fire

Annex C9

Figure C10: Definition of Hilti MT-C-GS OC connector local coordinate System for use with Hilti MT-50 S, MT-50, MT-50 S OC and MT-50 OC, installation channels

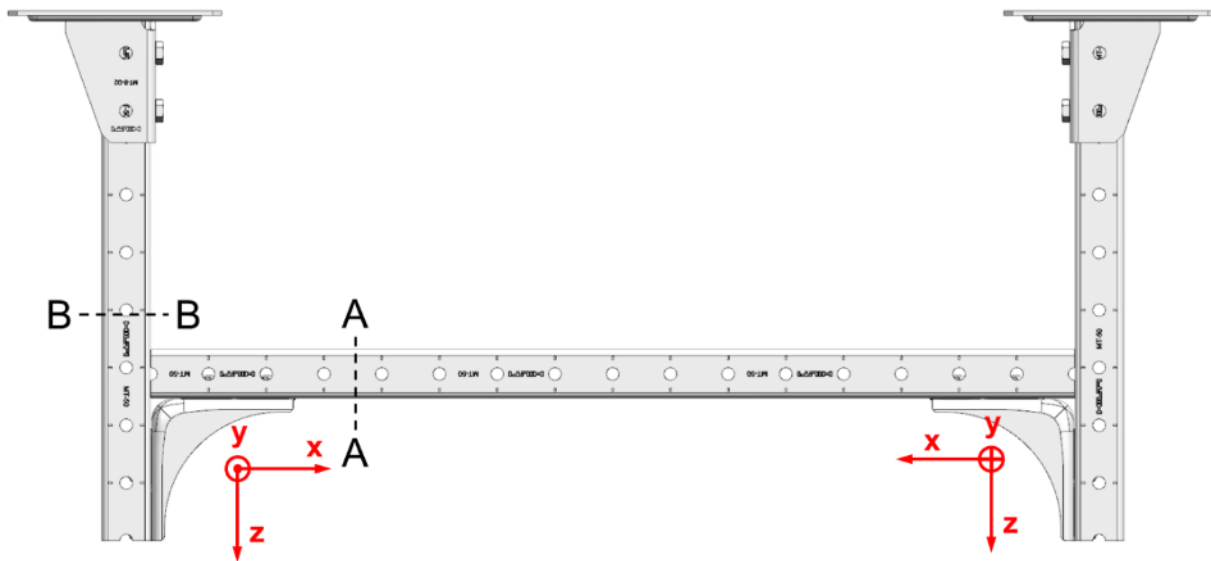

Table C18: Resistance $F_{Rk,t}$ and $M_{Rk,t}$ in case of fire after $t = 30, 60, 90$ and 120 minutes of Hilti MT-C-GS OC connector in combination with Hilti MT-50 S, MT-50, MT-50 S OC and MT-50 OC installation channels, view A-A

t	+ $F_{x,Rk,t}$	- $F_{x,Rk,t}$	+ $F_{y,Rk,t}$	- $F_{y,Rk,t}$	+ $F_{z,Rk,t}$	- $F_{z,Rk,t}$	+ $M_{x,Rk,t}$	- $M_{x,Rk,t}$	+ $M_{y,Rk,t}$	- $M_{y,Rk,t}$	+ $M_{z,Rk,t}$	- $M_{z,Rk,t}$	
min	N	N	N	N	N	N	Nm	Nm	Nm	Nm	Nm	Nm	
30	426,1	NPA	NPA	NPA	877,4	NPA	NPA	NPA	NPA	NPA	125,0	NPA	NPA
60	300,0				580,1						0,0		
90	300,0				481,0						0,0		
120	300,0				431,4						0,0		

Table C19: Resistance $F_{Rk,t}$ and $M_{Rk,t}$ in case of fire after $t = 30, 60, 90$ and 120 minutes of Hilti MT-C-GS OC connector in combination with Hilti MT-50 S, MT-50, MT-50 S OC and MT-50 OC installation channels, view B-B





t	+ $F_{x,Rk,t}$	- $F_{x,Rk,t}$	+ $F_{y,Rk,t}$	- $F_{y,Rk,t}$	+ $F_{z,Rk,t}$	- $F_{z,Rk,t}$	+ $M_{x,Rk,t}$	- $M_{x,Rk,t}$	+ $M_{y,Rk,t}$	- $M_{y,Rk,t}$	+ $M_{z,Rk,t}$	- $M_{z,Rk,t}$
min	N	N	N	N	N	N	Nm	Nm	Nm	Nm	Nm	Nm
30	NPA	689,6	NPA	NPA	NPA	1025,1	NPA	NPA	125,0	NPA	NPA	NPA
60		300,0				553,8			0,0			
90		300,0				396,7			0,0			
120		300,0				318,1			0,0			

Characteristic resistance of Hilti MT-C-GS connector in case of fire

Characteristic resistance of Hilti frame trapeze in case of fire

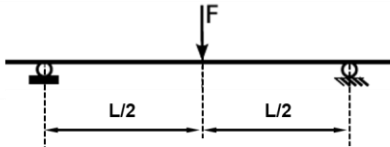
Annex C10

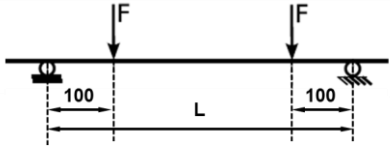
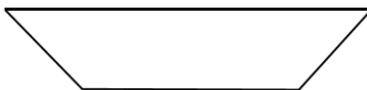
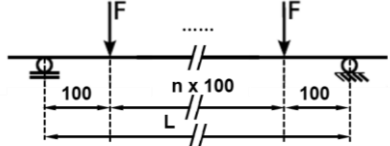
Table D1: Loading characteristics of Hilti channels

Loadcase	System	Resulting torque curve shape
1		
2		
3		

Symbols and designation

- L Distance between the supports in mm
- n number of 100 mm gaps between loads
- F Load

Hilti MT installation channels MT-40D, MT-50, MT-70 and MT-80

Bending characteristics of Hilti MT channels in case of fire

Annex D1

Table D2: Calculation-based deformation in case of fire for installation channels MT-40D, MT-40D S, MT-40D OC and MT-40D S OC

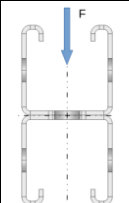
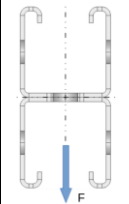
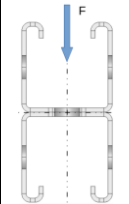
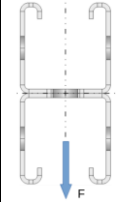
System			Load direction	σ_B MPa	$V^{(1)}$ -	$F^{(2)}$ N	$\delta_{t_{max};B}$ mm	$t_{max,B}$ min	δ_{30} mm	δ_{60} mm	δ_{90} mm	δ_{120} mm
Loadcase	L ⁽³⁾	n ⁽⁴⁾										
1	600	-		5	0,50	225,04	29,03	120,00	20,77	21,10	27,93	29,03
				10	0,50	459,99	34,30	106,67	22,57	24,76	32,96	-
				15	0,50	694,95	29,63	46,67	24,85	-	-	-
				20	0,50	929,90	24,07	26,67	-	-	-	-
				25	0,50	1164,86	16,09	20,00	-	-	-	-
				30	0,50	1399,81	16,76	20,00	-	-	-	-
1	600	-		5	0,50	225,04	29,76	120,00	21,01	21,55	28,54	29,76
				10	0,50	459,99	37,13	120,00	23,13	25,86	34,48	37,13
				15	0,50	694,95	51,07	93,33	25,89	32,55	48,92	-
				20	0,50	929,90	45,48	53,33	29,67	-	-	-
				25	0,50	1164,86	51,18	33,33	40,07	-	-	-
				30	0,50	1399,81	38,07	26,67	-	-	-	-
2	600	-		5	0,67	450,07	31,95	120,00	21,70	22,84	30,27	31,95
				10	0,67	919,98	49,52	100,00	25,55	32,51	45,49	-
				15	0,67	1389,89	41,81	40,00	31,78	-	-	-
				20	0,67	1859,80	33,88	26,67	-	-	-	-
				25	0,67	2329,71	19,03	20,00	-	-	-	-
				30	0,67	2799,62	11,26	13,33	-	-	-	-
2	600	-		5	0,67	450,07	31,23	120,00	21,54	22,50	29,74	31,23
				10	0,67	919,98	70,61	120,00	24,83	30,22	42,27	70,61
				15	0,67	1389,89	109,11	73,33	29,76	71,64	-	-
				20	0,67	1859,80	102,70	33,33	66,52	-	-	-
				25	0,67	2329,71	18,22	20,00	-	-	-	-
				30	0,67	2799,62	20,29	20,00	-	-	-	-

¹⁾ Momentum degree of fullness without contribution from channel dead weight

²⁾ Size of designated system's single load

³⁾ dimensions in mm

⁴⁾ distance between loads is 75 mm

Symbols and designation

- ϵ_{B,θ_a} Channel bending strain at elevated temperatures θ_a
- σ_B Channel bending stress
- V Momentum degree of fullness
- F Load
- $\delta_{t_{max};B}$ Deformation of the channel at the point in time of stability failure or of the plastic hinging
- $t_{max,B}$ Time in which loss of rigidity or plastic hinging of the channel occurs under bending stress
- δ_{30} Displacement after exposure time of 30 minutes to elevated temperatures
- δ_{60} Displacement after exposure time of 60 minutes to elevated temperatures
- δ_{90} Displacement after exposure time of 90 minutes to elevated temperatures
- δ_{120} Displacement after exposure time of 120 minutes to elevated temperatures

Thermal analyses as well as calculations are referring to the boundary conditions of STTC.

Hilti MT installation channels MT-40D, MT-50, MT-70 and MT-80

Bending characteristics of Hilti MT channels in case of fire

Annex D2

Table D3: Calculation-based deformation in case of fire for installation channels MT-40D, MT-40D S, MT-40D OC and MT-40D S OC

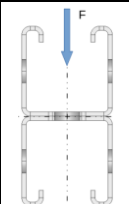
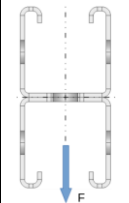
System			Load direction	σ_B	$V^{1)}$	$F^{2)}$	$\delta_{t_{max},B}$	$t_{max,B}$	δ_{30}	δ_{60}	δ_{90}	δ_{120}
Loadcase	$L^{3)}$	$n^{4)}$		MPa	-	N	mm	min	mm	mm	mm	mm
3	600	6		5	0,88	56,26	29,88	120,00	21,08	21,63	28,62	29,88
				10	0,88	115,00	39,10	120,00	23,46	26,83	36,01	39,10
				15	0,88	173,74	59,36	93,33	26,60	35,39	55,68	-
				20	0,88	232,48	53,74	53,33	31,27	-	-	-
				25	0,88	291,21	54,25	33,33	42,38	-	-	-
				30	0,88	349,95	42,81	26,67	-	-	-	-
3	600	6		5	0,88	56,26	30,13	120,00	21,18	21,80	28,83	30,13
				10	0,88	115,00	39,64	120,00	23,67	27,13	36,30	39,64
				15	0,88	173,74	88,93	73,33	26,88	37,36	-	-
				20	0,88	232,48	39,56	33,33	32,91	-	-	-
				25	0,88	291,21	31,49	26,67	-	-	-	-
				30	0,88	349,95	17,92	20,00	-	-	-	-

¹⁾ Momentum degree of fullness without contribution from channel dead weight

²⁾ Size of designated system's single load

³⁾ dimensions in mm

⁴⁾ distance between loads is 75 mm

Symbols and designation see Annex D1

Hilti MT installation channels MT-40D, MT-50, MT-70 and MT-80

Bending characteristics of Hilti MT channels in case of fire

Annex D3

Table D4: Calculation-based deformation in case of fire for installation channels MT-40D, MT-40D S, MT-40D OC and MT-40D S OC

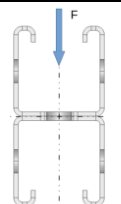
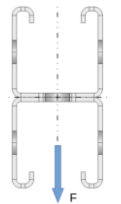
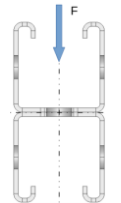
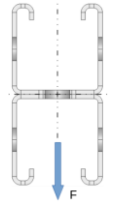
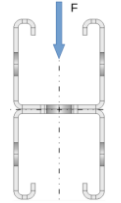
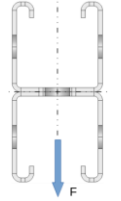
System			Load direction	σ_B	$V^{1)}$	$F^{2)}$	$\delta_{t_{max},B}$	$t_{max,B}$	δ_{30}	δ_{60}	δ_{90}	δ_{120}
Loadcase	$L^{3)}$	$n^{4)}$		MPa	-	N	mm	min	mm	mm	mm	mm
1	900	-		5	0,50	141,76	32,60	120,00	22,02	23,26	30,77	32,60
				10	0,50	298,40	45,36	120,00	25,68	30,86	41,26	45,36
				15	0,50	455,03	61,61	93,33	30,33	42,56	60,15	-
				20	0,50	611,67	60,56	60,00	36,58	60,56	-	-
				25	0,50	768,31	57,06	33,33	46,26	-	-	-
				30	0,50	924,94	45,50	26,67	-	-	-	-
1	900	-		5	0,50	141,76	33,02	120,00	22,16	23,52	31,12	33,02
				10	0,50	298,40	46,90	120,00	26,03	31,56	42,27	46,90
				15	0,50	455,03	83,81	73,33	30,99	44,65	-	-
				20	0,50	611,67	99,25	40,00	38,05	-	-	-
				25	0,50	768,31	37,11	26,67	-	-	-	-
				30	0,50	924,94	20,15	20,00	-	-	-	-
2	900	-		5	0,67	425,28	37,28	120,00	23,63	26,18	34,56	37,28
				10	0,67	895,19	216,07	120,00	30,87	44,28	172,94	216,07
				15	0,67	1365,10	352,83	120,00	42,55	224,71	322,16	352,83
				20	0,67	1835,01	48,14	26,67	-	-	-	-
				25	0,67	2304,92	22,94	20,00	-	-	-	-
				30	0,67	2774,83	12,84	13,33	-	-	-	-
2	900	-		5	0,67	425,28	36,50	120,00	23,46	25,81	33,99	36,50
				10	0,67	895,19	171,23	120,00	30,02	41,24	57,99	171,23
				15	0,67	1365,10	269,20	120,00	39,22	124,11	227,73	269,20
				20	0,67	1835,01	324,85	93,33	88,86	269,31	321,21	-
				25	0,67	2304,92	22,07	20,00	-	-	-	-
				30	0,67	2774,83	25,60	20,00	-	-	-	-
3	900	10		5	0,92	23,63	34,39	120,00	22,69	24,42	32,23	34,39
				10	0,92	49,73	53,46	120,00	27,56	35,26	47,63	53,46
				15	0,92	75,84	99,13	106,67	33,89	52,19	78,29	-
				20	0,92	101,94	105,46	66,67	43,24	83,43	-	-
				25	0,92	128,05	78,01	33,33	60,60	-	-	-
				30	0,92	154,16	63,45	26,67	-	-	-	-
3	900	10		5	0,92	23,63	34,40	120,00	22,70	24,44	32,25	34,40
				10	0,92	49,73	54,30	120,00	27,61	35,20	47,41	54,30
				15	0,92	75,84	302,03	120,00	33,89	56,23	241,46	302,03
				20	0,92	101,94	354,07	120,00	46,82	249,66	322,40	354,07
				25	0,92	128,05	46,17	26,67	-	-	-	-
				30	0,92	154,16	21,64	20,00	-	-	-	-

¹⁾ Momentum degree of fullness without contribution from channel dead weight

²⁾ Size of designated system's single load

³⁾ dimensions in mm

⁴⁾ distance between loads is 75 mm

Symbols and designation see Annex D1

Hilti MT installation channels MT-40D, MT-50, MT-70 and MT-80

Bending characteristics of Hilti MT channels in case of fire

Annex D4

Table D5: Calculation-based deformation in case of fire for installation channels MT-40D, MT-40D S, MT-40D OC and MT-40D S OC

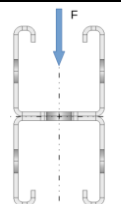
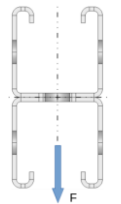
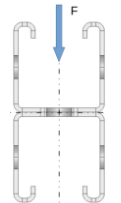
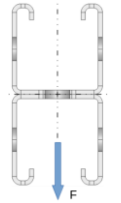
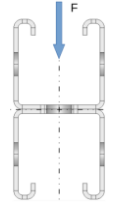
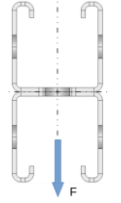
System			Load direction	σ_B MPa	$V^{1)}$ -	$F^{2)}$ N	$\delta_{t_{max},B}$ mm	$t_{max,B}$ min	δ_{30} mm	δ_{60} mm	δ_{90} mm	δ_{120} mm
Loadcase	$L^{3)}$	$n^{4)}$										
1	1200	-		5	0,50	97,64	38,03	120,00	23,92	26,56	35,10	38,03
				10	0,50	215,12	60,76	120,00	30,31	40,02	53,76	60,76
				15	0,50	332,60	100,54	93,33	38,43	60,69	94,64	-
				20	0,50	450,07	96,88	60,00	49,42	96,88	-	-
				25	0,50	567,55	98,24	33,33	73,19	-	-	-
				30	0,50	685,03	67,35	26,67	-	-	-	-
1	1200	-		5	0,50	97,64	38,33	120,00	24,03	26,75	35,35	38,33
				10	0,50	215,12	63,62	120,00	30,58	40,57	54,82	63,62
				15	0,50	332,60	124,16	66,67	38,98	77,89	-	-
				20	0,50	450,07	82,47	33,33	60,51	-	-	-
				25	0,50	567,55	50,68	26,67	-	-	-	-
				30	0,50	685,03	24,23	20,00	-	-	-	-
2	1200	-		5	0,67	390,57	44,88	120,00	26,35	30,91	40,66	44,88
				10	0,67	860,48	297,70	120,00	38,46	62,61	236,26	297,70
				15	0,67	1330,39	451,21	120,00	89,14	266,52	361,85	451,21
				20	0,67	450,07	82,47	33,33	60,51	-	-	-
				25	0,67	567,55	50,68	26,67	-	-	-	-
				30	0,67	685,03	24,23	20,00	-	-	-	-
2	1200	-		5	0,67	390,57	44,06	120,00	26,17	30,51	40,07	44,06
				10	0,67	860,48	245,42	120,00	37,38	57,47	128,19	245,42
				15	0,67	1330,39	337,90	120,00	56,50	215,81	296,46	337,90
				20	0,67	1800,30	356,63	93,33	148,97	303,55	351,38	-
				25	0,67	2270,21	27,52	20,00	-	-	-	-
				30	0,67	2740,12	33,24	20,00	-	-	-	-
3	1200	14		5	0,94	12,21	41,25	120,00	25,15	28,69	37,76	41,25
				10	0,94	26,89	74,91	120,00	33,66	47,82	64,97	74,91
				15	0,94	41,57	215,97	120,00	44,62	76,85	119,32	215,97
				20	0,94	56,26	404,68	120,00	60,71	135,49	330,01	404,68
				25	0,94	70,94	417,72	120,00	92,26	299,78	378,43	417,72
				30	0,94	85,63	435,77	120,00	183,39	334,63	396,70	435,77
3	1200	14		5	0,94	12,21	41,05	120,00	25,08	28,57	37,59	41,05
				10	0,94	26,89	77,11	120,00	33,59	47,51	64,45	77,11
				15	0,94	41,57	320,15	120,00	44,48	79,83	267,60	320,15
				20	0,94	56,26	406,31	120,00	68,73	274,25	360,25	406,31
				25	0,94	70,94	471,09	120,00	168,76	357,24	431,36	471,09
				30	0,94	85,63	27,26	20,00	-	-	-	-

¹⁾ Momentum degree of fullness without contribution from channel dead weight

²⁾ Size of designated system's single load

³⁾ dimensions in mm

⁴⁾ distance between loads is 75 mm

Symbols and designation see Annex D1

Hilti MT installation channels MT-40D, MT-50, MT-70 and MT-80

Bending characteristics of Hilti MT channels in case of fire

Annex D5

Table D6: Calculation-based deformation in case of fire for installation channels MT-40D, MT-40D S, MT-40D OC and MT-40D S OC

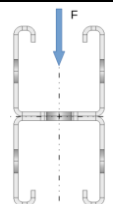
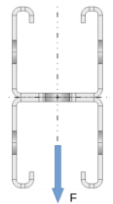
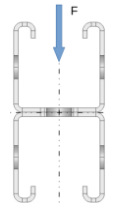
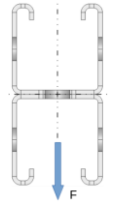
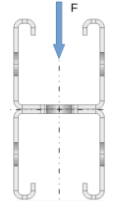
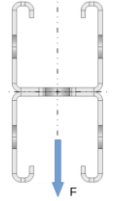
System			Load direction	σ_B MPa	$V^{1)}$ -	$F^{2)}$ N	$\delta_{t_{max},B}$ mm	$t_{max,B}$ min	δ_{30} mm	δ_{60} mm	δ_{90} mm	δ_{120} mm
Loadcase	$L^{3)}$	$n^{4)}$										
1	1500	-		5	0,50	69,19	45,74	120,00	26,63	31,26	41,26	45,74
				10	0,50	163,17	82,38	120,00	36,66	52,69	71,13	82,38
				15	0,50	257,15	535,47	120,00	49,36	85,67	365,37	535,47
				20	0,50	351,13	614,33	120,00	66,93	397,13	559,35	614,33
				25	0,50	445,12	65,42	26,67	-	-	-	-
				30	0,50	539,10	100,62	26,67	-	-	-	-
1	1500	-		5	0,50	69,19	45,96	120,00	26,71	31,40	41,44	45,96
				10	0,50	163,17	142,87	120,00	36,88	53,38	74,25	142,87
				15	0,50	257,15	158,32	60,00	50,17	158,32	-	-
				20	0,50	351,13	50,18	26,67	-	-	-	-
				25	0,50	445,12	82,42	26,67	-	-	-	-
				30	0,50	539,10	29,74	20,00	-	-	-	-
2	1500	-		5	0,67	345,94	54,93	120,00	29,88	37,06	48,72	54,93
				10	0,67	815,85	369,45	120,00	48,57	131,06	308,28	369,45
				15	0,67	1285,76	459,22	120,00	138,22	337,06	414,37	459,22
				20	0,67	1755,67	28,80	20,00	-	-	-	-
				25	0,67	2225,58	35,81	20,00	-	-	-	-
				30	0,67	2695,49	47,51	20,00	-	-	-	-
2	1500	-		5	0,67	345,94	53,90	120,00	29,66	36,58	47,98	53,90
				10	0,67	815,85	306,27	120,00	46,97	92,37	228,43	306,27
				15	0,67	1285,76	399,57	120,00	96,73	281,78	358,66	399,57
				20	0,67	1755,67	419,41	93,33	218,19	356,20	415,04	-
				25	0,67	2225,58	34,54	20,00	-	-	-	-
				30	0,67	2695,49	43,76	20,00	-	-	-	-
3	1500	18		5	0,95	6,92	50,87	120,00	28,62	34,72	45,53	50,87
				10	0,95	16,32	103,91	120,00	41,90	64,82	88,37	103,91
				15	0,95	25,72	260,97	120,00	58,88	109,10	172,36	260,97
				20	0,95	35,11	446,80	120,00	83,63	185,15	363,88	446,80
				25	0,95	44,51	492,69	120,00	127,97	320,20	439,26	492,69
				30	0,95	53,91	524,41	120,00	212,58	389,87	476,04	524,41
3	1500	18		5	0,95	6,92	50,28	120,00	28,40	34,33	45,04	50,28
				10	0,95	16,32	105,82	120,00	41,66	64,16	87,48	105,82
				15	0,95	25,72	373,86	120,00	58,58	120,45	302,62	373,86
				20	0,95	35,11	454,01	120,00	93,96	310,78	404,32	454,01
				25	0,95	44,51	506,10	120,00	204,98	392,10	464,26	506,10
				30	0,95	53,91	34,71	20,00	-	-	-	-

1) Momentum degree of fullness without contribution from channel dead weight

2) Size of designated system's single load

3) dimensions in mm

4) distance between loads is 75 mm

Symbols and designation see Annex D1

Hilti MT installation channels MT-40D, MT-50, MT-70 and MT-80

Bending characteristics of Hilti MT channels in case of fire

Annex D6

Table D7: Calculation-based deformation in case of fire for installation channels MT-40D, MT-40D S, MT-40D OC and MT-40D S OC

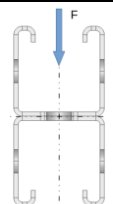
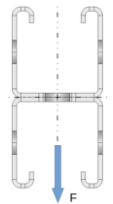
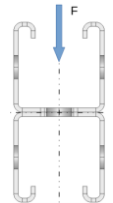
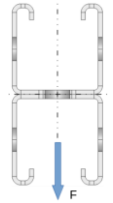
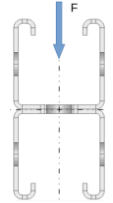
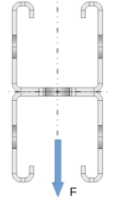
System			Load direction	σ_B	$V^{1)}$	$F^{2)}$	$\delta_{t_{max},B}$	$t_{max,B}$	δ_{30}	δ_{60}	δ_{90}	δ_{120}
Loadcase	$L^{3)}$	$n^{4)}$		MPa	-	N	mm	min	mm	mm	mm	mm
1	1800	-		5	0,50	48,56	56,23	120,00	30,35	37,73	49,67	56,23
				10	0,50	126,88	112,31	120,00	44,97	69,47	94,33	112,31
				15	0,50	205,20	643,50	120,00	63,43	120,15	465,60	643,50
				20	0,50	283,52	736,31	120,00	90,50	481,96	671,69	736,31
				25	0,50	361,84	88,15	26,67	-	-	-	-
				30	0,50	440,16	36,39	20,00	-	-	-	-
1	1800	-		5	0,50	48,56	56,56	120,00	30,40	37,84	49,89	56,56
				10	0,50	126,88	215,20	113,33	45,24	71,56	114,86	0,00
				15	0,50	205,20	255,72	60,00	66,42	255,72	-	-
				20	0,50	283,52	66,43	26,67	-	-	-	-
				25	0,50	361,84	31,28	20,00	-	-	-	-
				30	0,50	440,16	36,80	20,00	-	-	-	-
2	1800	-		5	0,67	291,39	68,72	120,00	34,23	44,74	59,13	68,72
				10	0,67	761,30	453,17	120,00	64,04	215,19	383,81	453,17
				15	0,67	1231,21	555,84	120,00	187,63	414,88	503,93	555,84
				20	0,67	1701,12	35,05	20,00	-	-	-	-
				25	0,67	2171,03	45,16	20,00	-	-	-	-
				30	0,67	2640,94	84,77	20,00	-	-	-	-
2	1800	-		5	0,67	291,39	67,40	120,00	33,98	44,17	58,23	67,40
				10	0,67	761,30	382,16	120,00	60,71	155,72	306,30	382,16
				15	0,67	1231,21	485,94	120,00	137,04	348,57	437,59	485,94
				20	0,67	1701,12	531,10	106,67	283,26	434,52	503,20	-
				25	0,67	2171,03	43,39	20,00	-	-	-	-
				30	0,67	2640,94	63,40	20,00	-	-	-	-
3	1800	22		5	0,96	4,05	63,87	120,00	33,35	42,93	56,10	63,87
				10	0,96	10,57	141,47	120,00	52,50	86,66	118,34	141,47
				15	0,96	17,10	297,70	120,00	76,83	148,75	222,35	297,70
				20	0,96	23,63	484,26	120,00	112,32	231,99	367,82	484,26
				25	0,96	30,15	555,64	120,00	165,54	324,29	477,35	555,64
				30	0,96	36,68	621,82	120,00	264,33	485,90	571,73	621,82
3	1800	22		5	0,96	4,05	62,58	120,00	32,85	42,06	55,01	62,58
				10	0,96	10,57	152,86	120,00	51,97	85,49	116,95	152,86
				15	0,96	17,10	515,00	120,00	76,35	283,85	442,53	515,00
				20	0,96	23,63	533,27	120,00	129,86	365,09	474,43	533,27
				25	0,96	30,15	594,47	120,00	268,94	459,35	544,96	594,47
				30	0,96	36,68	44,07	20,00	-	-	-	-

1) Momentum degree of fullness without contribution from channel dead weight

2) Size of designated system's single load

3) dimensions in mm

4) distance between loads is 75 mm

Symbols and designation see Annex D1

Hilti MT installation channels MT-40D, MT-50, MT-70 and MT-80

Bending characteristics of Hilti MT channels in case of fire

Annex D7

Table D8: Calculation-based deformation in case of fire for installation channels MT-40D, MT-40D S, MT-40D OC and MT-40D S OC

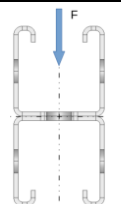
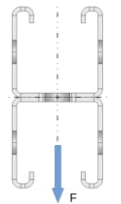
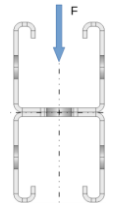
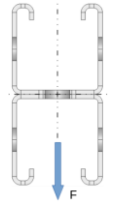
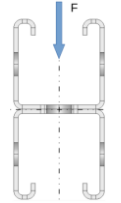
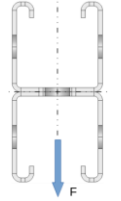
System			Load direction	σ_B	$V^{1)}$	$F^{2)}$	$\delta_{t_{max},B}$	$t_{max,B}$	δ_{30}	δ_{60}	δ_{90}	δ_{120}
Loadcase	L ³⁾	n ⁴⁾		MPa	-	N	mm	min	mm	mm	mm	mm
1	2100	-		5	0,50	32,42	70,26	120,00	35,34	46,42	60,99	70,26
				10	0,50	99,55	160,00	120,00	55,57	91,18	125,20	160,00
				15	0,50	166,68	754,89	120,00	81,09	179,27	586,20	754,89
				20	0,50	233,81	844,22	120,00	126,46	578,16	775,90	844,22
				25	0,50	300,94	914,22	120,00	345,59	761,26	866,24	914,22
				30	0,50	368,07	44,97	20,00	-	-	-	-
1	2100	-		5	0,50	32,42	71,58	120,00	35,38	46,62	61,65	71,58
				10	0,50	99,55	306,50	106,67	56,18	99,29	193,76	0,00
				15	0,50	166,68	320,74	53,33	92,19	-	-	-
				20	0,50	233,81	91,87	26,67	-	-	-	-
				25	0,50	300,94	37,93	20,00	-	-	-	-
				30	0,50	368,07	45,68	20,00	-	-	-	-
2	2100	-		5	0,67	226,92	95,31	120,00	39,45	54,31	73,91	95,31
				10	0,67	696,83	534,70	120,00	92,83	283,75	456,00	534,70
				15	0,67	1166,74	655,13	120,00	240,96	490,69	594,40	655,13
				20	0,67	1636,65	42,70	20,00	-	-	-	-
				25	0,67	2106,56	59,09	20,00	-	-	-	-
				30	0,67	2576,47	157,74	20,00	-	-	-	-
2	2100	-		5	0,67	226,92	92,91	120,00	39,20	53,76	73,15	92,91
				10	0,67	696,83	460,35	120,00	84,99	218,41	378,63	460,35
				15	0,67	1166,74	575,80	120,00	184,46	415,51	519,45	575,80
				20	0,67	1636,65	638,73	113,33	340,41	515,23	595,97	-
				25	0,67	2106,56	55,93	20,00	-	-	-	-
				30	0,67	2576,47	107,34	20,00	-	-	-	-
3	2100	26		5	0,96	2,32	81,18	120,00	39,61	53,87	70,32	81,18
				10	0,96	7,11	186,73	120,00	65,82	113,93	155,64	186,73
				15	0,96	11,91	341,37	120,00	98,81	193,17	272,87	341,37
				20	0,96	16,70	509,61	120,00	145,00	279,39	390,52	509,61
				25	0,96	21,50	650,97	120,00	206,30	363,26	582,77	650,97
				30	0,96	26,29	693,53	120,00	278,93	515,32	632,55	693,53
3	2100	26		5	0,96	2,32	78,70	120,00	38,65	52,19	68,17	78,70
				10	0,96	7,11	220,87	120,00	64,84	112,07	153,58	220,87
				15	0,96	11,91	581,64	120,00	98,03	308,03	499,02	581,64
				20	0,96	16,70	608,72	120,00	166,38	416,71	540,47	608,72
				25	0,96	21,50	679,83	120,00	319,85	522,61	622,08	679,83
				30	0,96	26,29	55,43	20,00	-	-	-	-

¹⁾ Momentum degree of fullness without contribution from channel dead weight

²⁾ Size of designated system's single load

³⁾ dimensions in mm

⁴⁾ distance between loads is 75 mm

Symbols and designation see Annex D1

Hilti MT installation channels MT-40D, MT-50, MT-70 and MT-80

Bending characteristics of Hilti MT channels in case of fire

Annex D8

Table D9: Calculation-based deformation in case of fire for installation channels MT-50, MT-50 U, MT-50 S, MT-50 OC and MT-50 S OC

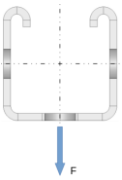
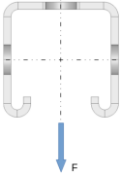
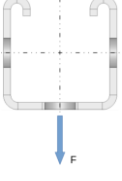
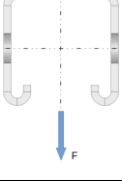
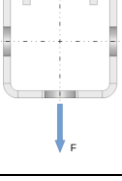
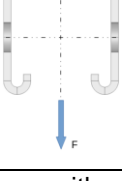
System			Load direction	σ_B	$V^{1)}$	$F^{2)}$	$\delta_{t_{max},B}$	$t_{max,B}$	δ_{30}	δ_{60}	δ_{90}	δ_{120}
Loadcase	$L^{3)}$	n		MPa	-	N	mm	min	mm	mm	mm	mm
1	500	-		5	0,50	122,79	9,93	120,00	7,50	7,50	9,93	9,93
				10	0,50	250,89	17,22	120,00	10,28	13,00	17,22	17,22
				15	0,50	379,00	36,62	120,00	13,10	19,74	28,87	36,62
				20	0,50	507,11	121,28	120,00	15,97	27,73	75,78	121,28
				25	0,50	635,22	140,57	120,00	18,95	39,35	115,74	140,57
				30	0,50	763,33	160,60	120,00	22,61	89,52	141,98	160,60
1	500	-		5	0,50	122,79	10,02	120,00	7,54	7,55	10,02	10,02
				10	0,50	250,89	17,36	120,00	10,36	13,16	17,36	17,36
				15	0,50	379,00	31,72	120,00	13,21	19,80	27,84	31,72
				20	0,50	507,11	59,92	106,67	16,08	27,08	45,86	-
				25	0,50	635,22	48,63	73,33	19,04	35,76	-	-
				30	0,50	763,33	49,46	60,00	22,31	49,46	-	-
2	500	-		5	0,67	153,48	12,25	120,00	8,53	9,34	12,25	12,25
				10	0,67	313,62	29,54	106,67	12,39	17,67	24,46	-
				15	0,67	473,75	24,19	53,33	16,29	-	-	-
				20	0,67	633,89	15,74	26,67	-	-	-	-
				25	0,67	794,02	6,73	20,00	-	-	-	-
				30	0,67	954,16	7,64	20,00	-	-	-	-
2	500	-		5	0,67	153,48	12,40	120,00	8,58	9,46	12,40	12,40
				10	0,67	313,62	24,65	120,00	12,53	17,95	23,70	24,65
				15	0,67	473,75	54,72	120,00	16,53	27,87	43,02	54,72
				20	0,67	633,89	57,89	80,00	20,56	38,74	-	-
				25	0,67	794,02	52,52	60,00	24,82	52,52	-	-
				30	0,67	954,16	51,68	46,67	30,86	-	-	-
3	500	33		5	0,80	51,16	11,35	120,00	8,12	8,60	11,35	11,35
				10	0,80	104,54	20,99	120,00	11,55	15,76	20,89	20,99
				15	0,80	157,92	38,93	93,33	15,05	24,35	37,73	-
				20	0,80	211,30	39,18	66,67	18,59	34,19	-	-
				25	0,80	264,67	33,21	46,67	22,26	-	-	-
				30	0,80	318,05	34,27	33,33	27,21	-	-	-
3	500	33		5	0,80	51,16	11,46	120,00	8,17	8,70	11,46	11,46
				10	0,80	104,54	21,15	120,00	11,66	15,98	21,11	21,15
				15	0,80	157,92	46,92	120,00	15,19	24,60	36,86	46,92
				20	0,80	211,30	68,02	93,33	18,76	34,11	64,24	-
				25	0,80	264,67	55,44	66,67	22,46	46,32	-	-
				30	0,80	318,05	57,75	53,33	27,30	-	-	-

¹⁾ Momentum degree of fullness without contribution from channel dead weight

²⁾ Size of designated system's single load

³⁾ dimensions in mm

Symbols and designation see Annex D1

Hilti MT installation channels MT-40D, MT-50, MT-70 and MT-80

Bending characteristics of Hilti MT channels in case of fire

Annex D9

Table D10: Calculation-based deformation in case of fire for installation channels MT-50, MT-50 U, MT-50 S, MT-50 OC and MT-50 S OC

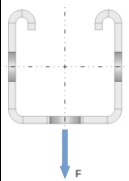
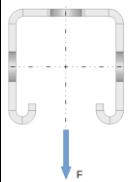
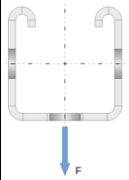
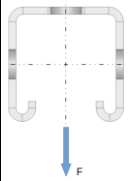
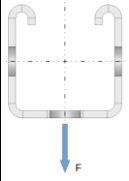
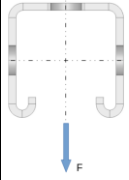
System			Load direction	σ_B	$V^{1)}$	$F^{2)}$	$\delta_{t_{max},B}$	$t_{max,B}$	δ_{30}	δ_{60}	δ_{90}	δ_{120}
Loadcase	$L^{3)}$	n		MPa	-	N	mm	min	mm	mm	mm	mm
1	700	-		5	0,50	84,06	15,96	120,00	10,15	12,34	15,96	15,96
				10	0,50	175,56	31,24	120,00	15,46	23,06	30,07	31,24
				15	0,50	267,07	110,67	120,00	20,88	35,87	52,26	110,67
				20	0,50	358,57	171,86	120,00	26,37	50,61	141,00	171,86
				25	0,50	450,08	203,36	120,00	32,00	114,31	178,10	203,36
				30	0,50	541,58	229,95	120,00	38,73	153,52	207,78	229,95
1	700	-		5	0,50	84,06	16,00	120,00	10,18	12,38	16,00	16,00
				10	0,50	175,56	30,84	120,00	15,51	23,02	29,88	30,84
				15	0,50	267,07	59,05	120,00	20,90	35,50	49,33	59,05
				20	0,50	358,57	95,65	106,67	26,31	48,86	79,15	-
				25	0,50	450,08	99,89	80,00	31,79	63,88	-	-
				30	0,50	541,58	96,53	60,00	40,22	96,53	-	-
2	700	-		5	0,67	147,10	20,84	120,00	12,31	16,28	20,84	20,84
				10	0,67	307,23	115,84	120,00	20,01	34,24	97,06	115,84
				15	0,67	467,37	105,04	60,00	27,88	105,04	-	-
				20	0,67	627,50	26,84	26,67	-	-	-	-
				25	0,67	787,64	9,97	20,00	-	-	-	-
				30	0,67	947,77	11,79	20,00	-	-	-	-
2	700	-		5	0,67	147,10	20,93	120,00	12,34	16,36	20,93	20,93
				10	0,67	307,23	47,57	120,00	20,12	32,93	42,72	47,57
				15	0,67	467,37	86,89	120,00	27,91	51,31	73,61	86,89
				20	0,67	627,50	120,84	113,33	35,66	69,31	105,06	-
				25	0,67	787,64	117,95	80,00	43,53	87,39	-	-
				30	0,67	947,77	119,64	66,67	53,39	106,26	-	-
3	700	5		5	0,86	24,52	18,74	120,00	11,38	14,57	18,74	18,74
				10	0,86	51,21	40,15	120,00	17,97	28,24	36,84	40,15
				15	0,86	77,89	68,81	93,33	24,62	44,09	66,48	-
				20	0,86	104,58	69,64	66,67	31,30	61,24	-	-
				25	0,86	131,27	58,57	46,67	38,14	-	-	-
				30	0,86	157,96	59,47	33,33	46,96	-	-	-
3	700	5		5	0,86	24,52	18,81	120,00	11,41	14,65	18,81	18,81
				10	0,86	51,21	40,15	120,00	18,06	28,46	36,99	40,15
				15	0,86	77,89	78,46	120,00	24,76	44,37	63,93	78,46
				20	0,86	104,58	131,24	120,00	31,46	60,84	98,26	131,24
				25	0,86	131,27	131,04	86,67	38,27	78,89	-	-
				30	0,86	157,96	119,58	66,67	46,49	101,36	-	-

¹⁾ Momentum degree of fullness without contribution from channel dead weight

²⁾ Size of designated system's single load

³⁾ dimensions in mm

Symbols and designation see Annex D1

Hilti MT installation channels MT-40D, MT-50, MT-70 and MT-80

Bending characteristics of Hilti MT channels in case of fire

Annex D10

Table D11: Calculation-based deformation in case of fire for installation channels MT-50, MT-50 U, MT-50 S, MT-50 OC and MT-50 S OC

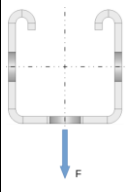
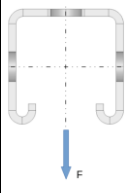
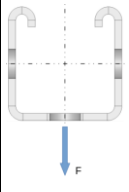
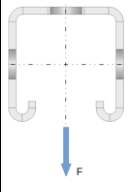
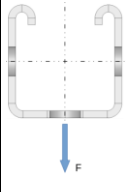
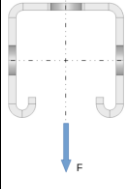
System			Load direction	σ_B	$V^{1)}$	$F^{2)}$	$\delta_{t_{max},B}$	$t_{max,B}$	δ_{30}	δ_{60}	δ_{90}	δ_{120}
Loadcase	$L^{3)}$	n		MPa	-	N	mm	min	mm	mm	mm	mm
1	900	-		5	0,50	61,59	24,43	120,00	13,87	19,18	24,43	24,43
				10	0,50	132,76	51,51	120,00	22,59	36,65	47,25	51,51
				15	0,50	203,93	181,22	120,00	31,40	57,08	93,17	181,22
				20	0,50	275,10	238,05	120,00	40,22	87,12	205,02	238,05
				25	0,50	346,28	273,17	120,00	49,20	179,15	245,05	273,17
				30	0,50	417,45	299,31	120,00	61,64	217,52	273,58	299,31
1	900	-		5	0,50	61,59	24,33	120,00	13,86	19,13	24,33	24,33
				10	0,50	132,76	50,70	120,00	22,54	36,41	46,84	50,70
				15	0,50	203,93	92,90	120,00	31,28	56,33	77,08	92,90
				20	0,50	275,10	150,23	113,33	39,99	76,97	118,85	-
				25	0,50	346,28	141,64	80,00	48,74	98,85	-	-
				30	0,50	417,45	144,02	66,67	58,12	124,90	-	-
2	900	-		5	0,67	138,58	32,30	120,00	17,34	25,49	32,30	32,30
				10	0,67	298,72	138,36	120,00	30,16	86,28	121,58	138,36
				15	0,67	458,85	133,34	60,00	54,29	133,34	-	-
				20	0,67	618,99	42,60	26,67	-	-	-	-
				25	0,67	779,12	14,30	20,00	-	-	-	-
				30	0,67	939,26	17,35	20,00	-	-	-	-
2	900	-		5	0,67	138,58	32,19	120,00	17,34	25,50	32,19	32,19
				10	0,67	298,72	75,18	120,00	30,14	52,02	66,44	75,18
				15	0,67	458,85	120,51	120,00	42,72	79,34	106,02	120,51
				20	0,67	618,99	160,37	120,00	54,92	103,27	141,79	160,37
				25	0,67	779,12	184,14	113,33	66,89	124,93	168,09	-
				30	0,67	939,26	192,17	93,33	79,93	143,82	189,30	-
3	900	7		5	0,89	13,86	28,86	120,00	15,87	22,76	28,86	28,86
				10	0,89	29,87	64,52	120,00	26,58	44,64	57,52	64,52
				15	0,89	45,89	101,76	93,33	37,28	68,73	98,39	-
				20	0,89	61,90	104,37	66,67	47,84	92,86	-	-
				25	0,89	77,91	88,04	46,67	58,39	-	-	-
				30	0,89	93,93	88,40	33,33	70,66	-	-	-
3	900	7		5	0,89	13,86	28,88	120,00	15,87	22,81	28,88	28,88
				10	0,89	29,87	64,84	120,00	26,71	45,06	57,91	64,84
				15	0,89	45,89	114,33	120,00	37,52	69,61	96,13	114,33
				20	0,89	61,90	166,59	120,00	48,17	93,27	137,86	166,59
				25	0,89	77,91	210,62	120,00	58,77	116,54	172,96	210,62
				30	0,89	93,93	211,25	93,33	70,68	140,46	205,51	-

¹⁾ Momentum degree of fullness without contribution from channel dead weight

²⁾ Size of designated system's single load

³⁾ dimensions in mm

Symbols and designation see Annex D1

Hilti MT installation channels MT-40D, MT-50, MT-70 and MT-80

Bending characteristics of Hilti MT channels in case of fire

Annex D11

Table D12: Calculation-based deformation in case of fire for installation channels MT-50, MT-50 U, MT-50 S, MT-50 OC and MT-50 S OC

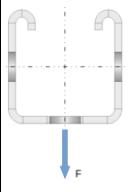
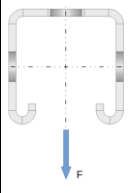
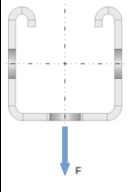
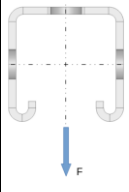
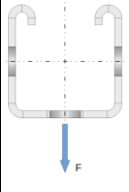
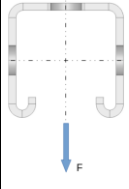
System			Load direction	σ_B	$V^{1)}$	$F^{2)}$	$\delta_{t_{max},B}$	$t_{max,B}$	δ_{30}	δ_{60}	δ_{90}	δ_{120}
Loadcase	$L^3)$	n		MPa	-	N	mm	min	mm	mm	mm	mm
1	1100	-		5	0,50	46,52	35,51	120,00	18,79	28,18	35,51	35,51
				10	0,50	104,75	77,38	120,00	31,69	53,79	68,91	77,38
				15	0,50	162,98	232,92	120,00	44,59	83,58	186,12	232,92
				20	0,50	221,22	102,01	53,33	57,42	-	-	-
				25	0,50	279,45	98,91	40,00	70,55	-	-	-
				30	0,50	337,68	62,35	26,67	-	-	-	-
1	1100	-		5	0,50	46,52	35,29	120,00	18,72	28,01	35,29	35,29
				10	0,50	104,75	75,65	120,00	31,55	53,45	68,27	75,65
				15	0,50	162,98	132,07	120,00	44,40	82,01	110,31	132,07
				20	0,50	221,22	201,86	113,33	57,09	110,50	163,46	-
				25	0,50	279,45	190,74	80,00	69,69	139,21	-	-
				30	0,50	337,68	192,59	66,67	82,91	170,74	-	-
2	1100	-		5	0,67	127,94	69,64	120,00	23,63	37,28	51,26	69,64
				10	0,67	288,07	166,94	120,00	45,83	118,04	151,28	166,94
				15	0,67	448,21	208,96	120,00	82,64	161,63	194,51	208,96
				20	0,67	608,34	66,45	26,67	-	-	-	-
				25	0,67	768,48	19,72	20,00	-	-	-	-
				30	0,67	928,61	24,44	20,00	-	-	-	-
2	1100	-		5	0,67	127,94	46,58	120,00	23,57	36,80	46,06	46,58
				10	0,67	288,07	105,86	120,00	42,44	74,43	93,66	105,86
				15	0,67	448,21	156,11	120,00	60,57	110,19	139,76	156,11
				20	0,67	608,34	198,07	120,00	77,62	139,15	179,18	198,07
				25	0,67	768,48	228,57	120,00	93,81	163,52	207,93	228,57
				30	0,67	928,61	246,28	113,33	109,65	184,15	229,66	-
3	1100	9		5	0,91	8,53	42,16	120,00	21,72	33,36	41,93	42,16
				10	0,91	19,20	93,20	120,00	37,46	64,70	82,35	93,20
				15	0,91	29,88	169,49	100,00	52,91	97,12	141,99	-
				20	0,91	40,56	154,49	73,33	68,64	127,81	-	-
				25	0,91	51,23	121,70	46,67	82,41	-	-	-
				30	0,91	61,91	121,60	33,33	98,42	-	-	-
3	1100	9		5	0,91	8,53	42,02	120,00	21,67	33,37	41,88	42,02
				10	0,91	19,20	94,22	120,00	37,63	65,57	83,31	94,22
				15	0,91	29,88	152,44	120,00	53,35	99,12	131,42	152,44
				20	0,91	40,56	209,35	120,00	68,55	129,35	179,23	209,35
				25	0,91	51,23	251,75	120,00	83,34	157,13	217,57	251,75
				30	0,91	61,91	287,79	120,00	98,86	182,88	248,92	287,79

¹⁾ Momentum degree of fullness without contribution from channel dead weight

²⁾ Size of designated system's single load

³⁾ dimensions in mm

Symbols and designation see Annex D1

Hilti MT installation channels MT-40D, MT-50, MT-70 and MT-80

Bending characteristics of Hilti MT channels in case of fire

Annex D12

Table D13: Calculation-based deformation in case of fire for installation channels MT-50, MT-50 U, MT-50 S, MT-50 OC and MT-50 S OC

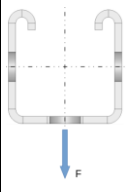
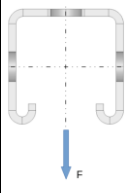
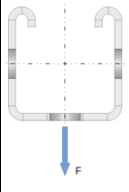
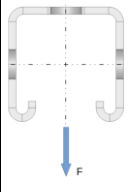
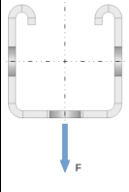
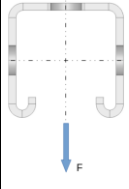
System			Load direction	σ_B	$V^{1)}$	$F^{2)}$	$\delta_{t_{max},B}$	$t_{max,B}$	δ_{30}	δ_{60}	δ_{90}	δ_{120}
Loadcase	$L^{3)}$	n		MPa	-	N	mm	min	mm	mm	mm	mm
1	1300	-		5	0,50	35,44	50,34	120,00	25,05	39,53	49,47	50,34
				10	0,50	84,71	110,76	120,00	42,85	74,60	95,11	110,76
				15	0,50	133,98	299,78	120,00	60,52	117,38	254,76	299,78
				20	0,50	183,25	115,26	46,67	77,98	-	-	-
				25	0,50	232,52	119,54	33,33	95,25	-	-	-
				30	0,50	281,80	84,75	26,67	-	-	-	-
1	1300	-		5	0,50	35,44	50,00	120,00	24,90	39,29	49,17	50,00
				10	0,50	84,71	105,56	120,00	42,67	74,21	94,15	105,56
				15	0,50	133,98	175,33	120,00	60,29	112,15	148,12	175,33
				20	0,50	183,25	256,98	113,33	77,52	148,52	211,44	-
				25	0,50	232,52	242,90	80,00	94,39	183,66	-	-
				30	0,50	281,80	244,50	66,67	111,70	219,94	-	-
2	1300	-		5	0,67	115,16	102,17	120,00	31,30	56,59	87,55	102,17
				10	0,67	275,30	197,57	120,00	68,95	145,84	179,80	197,57
				15	0,67	435,43	241,56	120,00	110,98	190,82	224,88	241,56
				20	0,67	595,57	262,49	120,00	152,69	216,30	248,21	262,49
				25	0,67	755,70	281,76	120,00	181,47	238,04	268,71	281,76
				30	0,67	915,84	301,03	120,00	210,25	259,79	289,21	301,03
2	1300	-		5	0,67	115,16	64,39	120,00	31,00	50,14	62,34	64,39
				10	0,67	275,30	138,69	120,00	56,87	99,42	123,47	138,69
				15	0,67	435,43	194,19	120,00	81,02	142,85	175,09	194,19
				20	0,67	595,57	237,81	120,00	103,06	176,41	217,72	237,81
				25	0,67	755,70	270,36	120,00	123,41	203,12	249,10	270,36
				30	0,67	915,84	297,44	120,00	142,23	225,47	272,82	297,44
3	1300	11		5	0,92	5,48	59,91	120,00	29,08	46,52	58,07	59,91
				10	0,92	13,11	125,36	120,00	50,63	87,98	110,62	125,36
				15	0,92	20,73	292,41	120,00	71,27	128,12	205,04	292,41
				20	0,92	28,36	348,80	120,00	90,79	184,70	310,77	348,80
				25	0,92	35,99	384,34	120,00	109,53	262,82	350,60	384,34
				30	0,92	43,61	186,45	40,00	127,94	-	-	-
3	1300	11		5	0,92	5,48	59,64	120,00	28,91	46,47	57,95	59,64
				10	0,92	13,11	127,34	120,00	50,90	89,60	112,53	127,34
				15	0,92	20,73	191,96	120,00	72,07	131,68	168,55	191,96
				20	0,92	28,36	252,24	120,00	92,15	167,59	221,11	252,24
				25	0,92	35,99	298,34	120,00	111,27	199,12	262,65	298,34
				30	0,92	43,61	334,07	120,00	130,15	226,91	296,39	334,07

¹⁾ Momentum degree of fullness without contribution from channel dead weight

²⁾ Size of designated system's single load

³⁾ dimensions in mm

Symbols and designation see Annex D1

Hilti MT installation channels MT-40D, MT-50, MT-70 and MT-80

Bending characteristics of Hilti MT channels in case of fire

Annex D13

Table D14: Calculation-based deformation in case of fire for installation channels MT-50, MT-50 U, MT-50 S, MT-50 OC and MT-50 S OC

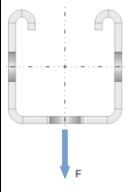
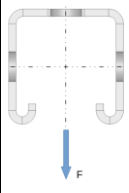
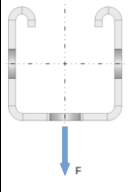
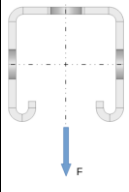
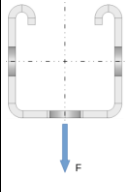
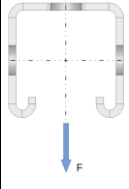
System			Load direction	σ_B	$V^{1)}$	$F^{2)}$	$\delta_{t_{max},B}$	$t_{max,B}$	δ_{30}	δ_{60}	δ_{90}	δ_{120}
Loadcase	$L^{3)}$	n		MPa	-	N	mm	min	mm	mm	mm	mm
1	1500	-		5	0,50	26,74	69,18	120,00	32,82	53,55	66,66	69,18
				10	0,50	69,44	156,55	120,00	56,23	99,36	128,32	156,55
				15	0,50	112,14	367,21	120,00	79,27	211,60	319,11	367,21
				20	0,50	154,84	138,88	40,00	102,11	-	-	-
				25	0,50	197,55	92,90	26,67	-	-	-	-
				30	0,50	240,25	110,95	26,67	-	-	-	-
1	1500	-		5	0,50	26,74	68,76	120,00	32,60	53,23	66,29	68,76
				10	0,50	69,44	140,16	120,00	56,02	98,71	124,36	140,16
				15	0,50	112,14	221,93	120,00	78,99	146,31	189,72	221,93
				20	0,50	154,84	313,11	113,33	101,16	190,30	262,15	-
				25	0,50	197,55	297,15	80,00	122,62	231,42	-	-
				30	0,50	240,25	298,68	66,67	144,11	271,93	-	-
2	1500	-		5	0,67	100,26	127,09	120,00	40,94	85,50	114,48	127,09
				10	0,67	260,40	236,47	120,00	90,37	173,01	214,01	236,47
				15	0,67	420,53	282,98	120,00	138,78	223,88	263,32	282,98
				20	0,67	580,67	294,93	120,00	175,48	244,97	279,04	294,93
				25	0,67	740,80	314,56	120,00	205,20	268,02	300,53	314,56
				30	0,67	900,94	337,27	120,00	236,15	293,12	324,57	337,27
2	1500	-		5	0,67	100,26	84,66	120,00	39,59	65,40	80,89	84,66
				10	0,67	260,40	173,32	120,00	73,24	126,50	155,31	173,32
				15	0,67	420,53	234,91	120,00	103,71	176,89	212,13	234,91
				20	0,67	580,67	279,58	120,00	130,71	214,67	257,60	279,58
				25	0,67	740,80	314,39	120,00	155,03	243,98	291,77	314,39
				30	0,67	900,94	341,28	120,00	176,90	267,89	317,62	341,28
3	1500	13		5	0,93	3,58	81,20	120,00	38,13	62,43	77,46	81,20
				10	0,93	9,30	161,03	120,00	66,02	113,81	141,50	161,03
				15	0,93	15,02	302,22	120,00	92,10	161,24	225,03	302,22
				20	0,93	20,74	386,93	120,00	116,20	215,37	334,92	386,93
				25	0,93	26,46	429,91	120,00	139,35	282,47	389,36	429,91
				30	0,93	32,18	461,08	120,00	170,29	351,56	423,66	461,08
3	1500	13		5	0,93	3,58	80,83	120,00	37,77	62,32	77,29	80,83
				10	0,93	9,30	163,12	120,00	66,46	116,60	144,74	163,12
				15	0,93	15,02	232,89	120,00	93,49	166,35	206,97	232,89
				20	0,93	20,74	295,33	120,00	118,50	207,12	263,13	295,33
				25	0,93	26,46	344,69	120,00	141,84	241,72	307,81	344,69
				30	0,93	32,18	383,46	120,00	163,95	271,88	343,97	383,46

¹⁾ Momentum degree of fullness without contribution from channel dead weight

²⁾ Size of designated system's single load

³⁾ dimensions in mm



Symbols and designation see Annex D1

Hilti MT installation channels MT-40D, MT-50, MT-70 and MT-80

Bending characteristics of Hilti MT channels in case of fire

Annex D14

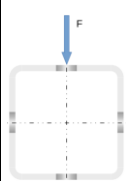
Table D15: Calculation-based deformation in case of fire for installation channels MT-70 S OC and MT-70 OC

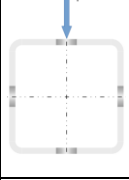
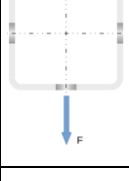
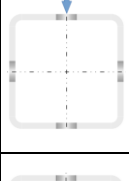
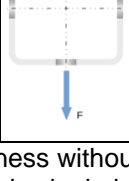
System			Load direction	σ_B	$V^{1)}$	$F^{2)}$	$\delta_{t_{max};B}$	$t_{max,B}$	δ_{30}	δ_{60}	δ_{90}	δ_{120}
Loadcase	$L^{3)}$	n		MPa	-	N	mm	min	mm	mm	mm	mm
1	500	-		5	0,50	247,05	32,35	120,00	7,01	32,35	32,35	32,35
				10	0,50	502,41	38,36	120,00	8,14	38,36	38,36	38,36
				15	0,50	757,77	51,59	120,00	9,72	46,90	46,90	51,59
				20	0,50	1013,13	156,46	120,00	12,34	62,06	80,63	156,46
				25	0,50	1268,49	195,33	120,00	17,55	88,46	170,56	195,33
				30	0,50	1523,85	210,65	120,00	27,60	155,54	199,01	210,65
1	500	-		5	0,50	247,05	33,21	120,00	7,35	33,21	33,21	33,21
				10	0,50	502,41	40,17	120,00	9,05	40,17	40,17	40,17
				15	0,50	757,77	48,64	120,00	11,37	48,64	48,64	48,64
				20	0,50	1013,13	87,28	120,00	14,52	61,32	66,88	87,28
				25	0,50	1268,49	152,03	120,00	19,08	80,44	107,53	152,03
				30	0,50	1523,85	204,09	120,00	26,54	107,19	158,87	204,09
2	500	-		5	0,67	308,81	34,80	120,00	7,45	34,80	34,80	34,80
				10	0,67	628,01	44,09	120,00	9,33	44,09	44,09	44,09
				15	0,67	947,21	89,44	120,00	12,11	62,12	71,78	89,44
				20	0,67	1266,41	126,51	120,00	17,81	92,92	111,00	126,51
				25	0,67	1585,61	146,44	120,00	32,42	123,99	136,97	146,44
				30	0,67	1904,81	151,99	90,91	58,28	146,85	151,37	-
2	500	-		5	0,67	308,81	34,60	120,00	7,44	34,60	34,60	34,60
				10	0,67	628,01	42,86	120,00	9,23	42,86	42,86	42,86
				15	0,67	947,21	64,64	120,00	11,58	55,84	55,84	64,64
				20	0,67	1266,41	99,95	120,00	15,83	75,67	84,86	99,95
				25	0,67	1585,61	124,97	117,77	25,13	100,20	111,00	-
				30	0,67	1904,81	132,35	86,10	40,33	120,99	-	-
3	500	3		5	0,80	102,94	33,77	120,00	7,27	33,77	33,77	33,77
				10	0,80	209,34	41,46	120,00	8,80	41,46	41,46	41,46
				15	0,80	315,74	76,61	120,00	10,82	53,94	57,32	76,61
				20	0,80	422,14	138,95	120,00	14,43	78,29	107,97	138,95
				25	0,80	528,54	184,65	120,00	22,94	115,77	155,14	184,65
				30	0,80	634,94	206,49	120,00	40,89	155,52	188,56	206,49
3	500	3		5	0,80	102,94	33,74	120,00	7,28	33,74	33,74	33,74
				10	0,80	209,34	41,12	120,00	8,81	41,12	41,12	41,12
				15	0,80	315,74	58,64	120,00	10,77	51,80	51,80	58,64
				20	0,80	422,14	101,04	120,00	14,07	69,47	81,67	101,04
				25	0,80	528,54	138,89	120,00	20,88	94,70	117,43	138,89
				30	0,80	634,94	167,03	120,00	33,06	122,34	145,78	167,03

¹⁾ Momentum degree of fullness without contribution from channel dead weight

²⁾ Size of designated system's single load

³⁾ dimensions in mm



Symbols and designation see Annex D1

Hilti MT installation channels MT-40D, MT-50, MT-70 and MT-80

Bending characteristics of Hilti MT channels in case of fire

Annex D15

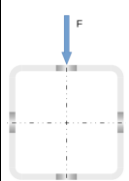
Table D16: Calculation-based deformation in case of fire for installation channels MT-70 S OC and MT-70 OC

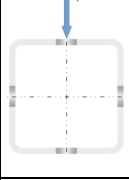
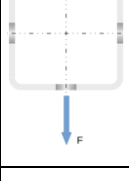
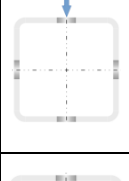
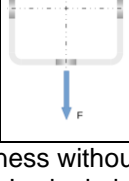
System			Load direction	σ_B	$V^{1)}$	$F^{2)}$	$\delta_{t_{max};B}$	$t_{max,B}$	δ_{30}	δ_{60}	δ_{90}	δ_{120}
Loadcase	$L^{3)}$	n		MPa	-	N	mm	min	mm	mm	mm	mm
1	800	-		5	0,50	146,30	37,15	120,00	8,03	37,15	37,15	37,15
				10	0,50	305,90	51,36	120,00	10,79	51,36	51,36	51,36
				15	0,50	465,50	104,98	120,00	14,35	70,27	83,77	104,98
				20	0,50	625,10	188,53	120,00	19,81	101,73	143,75	188,53
				25	0,50	784,70	287,59	120,00	30,42	146,59	216,85	287,59
				30	0,50	944,30	328,95	120,00	50,99	199,96	291,64	328,95
1	800	-		5	0,50	146,30	37,59	120,00	8,21	37,59	37,59	37,59
				10	0,50	305,90	52,26	120,00	11,24	52,26	52,26	52,26
				15	0,50	465,50	97,60	120,00	15,13	70,67	81,20	97,60
				20	0,50	625,10	166,31	120,00	20,78	99,10	132,52	166,31
				25	0,50	784,70	230,37	120,00	30,49	138,44	189,70	230,37
				30	0,50	944,30	288,75	120,00	47,64	181,46	240,91	288,75
2	800	-		5	0,67	292,60	43,33	120,00	9,08	43,33	43,33	43,33
				10	0,67	611,80	90,19	120,00	13,76	67,02	75,78	90,19
				15	0,67	931,00	160,84	120,00	20,48	110,06	140,50	160,84
				20	0,67	1250,20	205,97	120,00	34,67	159,09	187,44	205,97
				25	0,67	1569,40	228,43	120,00	71,07	198,04	215,41	228,43
				30	0,67	1888,60	232,96	96,35	114,76	223,65	231,31	-
2	800	-		5	0,67	292,60	42,77	120,00	9,05	42,77	42,77	42,77
				10	0,67	611,80	75,64	120,00	13,56	63,70	66,53	75,64
				15	0,67	931,00	121,54	120,00	19,51	93,48	108,82	121,54
				20	0,67	1250,20	161,78	120,00	30,49	128,95	148,58	161,78
				25	0,67	1569,40	185,20	119,26	53,27	159,84	174,52	-
				30	0,67	1888,60	192,40	86,74	82,82	183,55	-	-
3	800	6		5	0,88	36,57	39,96	120,00	8,52	39,96	39,96	39,96
				10	0,88	76,47	66,72	120,00	12,13	58,08	58,37	66,72
				15	0,88	116,37	135,21	120,00	16,79	84,91	109,54	135,21
				20	0,88	156,27	206,64	120,00	24,72	127,76	171,73	206,64
				25	0,88	196,17	258,44	120,00	42,19	178,22	226,12	258,44
				30	0,88	236,07	301,74	120,00	74,97	221,82	266,99	301,74
3	800	6		5	0,88	36,57	39,97	120,00	8,56	39,97	39,97	39,97
				10	0,88	76,47	63,97	120,00	12,21	57,74	57,74	63,97
				15	0,88	116,37	119,67	120,00	16,86	82,23	100,40	119,67
				20	0,88	156,27	182,25	120,00	24,53	118,83	153,63	182,25
				25	0,88	196,17	225,13	120,00	40,12	161,71	198,90	225,13
				30	0,88	236,07	257,18	120,00	67,32	198,63	234,53	257,18

¹⁾ Momentum degree of fullness without contribution from channel dead weight

²⁾ Size of designated system's single load

³⁾ dimensions in mm



Symbols and designation see Annex D1

Hilti MT installation channels MT-40D, MT-50, MT-70 and MT-80

Bending characteristics of Hilti MT channels in case of fire

Annex D16

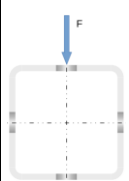
Table D17: Calculation-based deformation in case of fire for installation channels MT-70 S OC and MT-70 OC

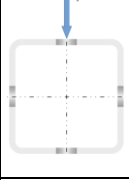
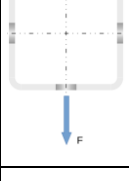
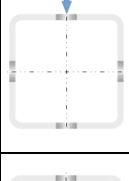
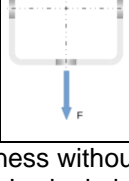
System			Load direction	σ_B	$V^{1)}$	$F^{2)}$	$\delta_{t_{max};B}$	$t_{max,B}$	δ_{30}	δ_{60}	δ_{90}	δ_{120}
Loadcase	$L^{3)}$	n		MPa	-	N	mm	min	mm	mm	mm	mm
1	1100	-		5	0,50	97,78	44,47	120,00	9,57	44,47	44,47	44,47
				10	0,50	213,85	90,08	120,00	14,71	70,67	79,48	90,08
				15	0,50	329,93	170,78	120,00	21,23	103,99	140,03	170,78
				20	0,50	446,00	265,95	120,00	31,02	154,31	218,39	265,95
				25	0,50	562,07	357,23	120,00	49,47	216,07	294,52	357,23
				30	0,50	678,15	429,03	120,00	83,56	277,03	366,09	429,03
1	1100	-		5	0,50	97,78	44,71	120,00	9,68	44,71	44,71	44,71
				10	0,50	213,85	89,97	120,00	14,98	71,12	79,75	89,97
				15	0,50	329,93	164,55	120,00	21,69	103,81	137,45	164,55
				20	0,50	446,00	253,90	120,00	31,52	151,68	210,69	253,90
				25	0,50	562,07	322,83	120,00	49,02	209,61	278,99	322,83
				30	0,50	678,15	382,96	120,00	79,99	264,61	335,99	382,96
2	1100	-		5	0,67	268,90	55,51	120,00	11,38	55,51	55,51	55,51
				10	0,67	588,10	155,74	120,00	20,19	100,15	131,71	155,74
				15	0,67	907,30	236,04	120,00	32,82	169,15	213,11	236,04
				20	0,67	1226,50	289,73	120,00	59,95	229,94	269,43	289,73
				25	0,67	1545,70	316,31	120,00	118,75	272,79	301,35	316,31
				30	0,67	1864,90	324,77	99,78	177,03	304,89	322,28	-
2	1100	-		5	0,67	268,90	54,19	120,00	11,32	54,19	54,19	54,19
				10	0,67	588,10	128,59	120,00	19,76	92,55	112,91	128,59
				15	0,67	907,30	183,94	120,00	30,85	139,04	166,72	183,94
				20	0,67	1226,50	226,11	120,00	51,05	186,85	212,57	226,11
				25	0,67	1545,70	249,89	120,00	88,10	221,42	241,50	249,89
				30	0,67	1864,90	258,55	88,59	128,57	246,83	-	-
3	1100	9		5	0,91	17,93	49,62	120,00	10,47	49,62	49,62	49,62
				10	0,91	39,21	119,82	120,00	17,31	83,49	102,56	119,82
				15	0,91	60,49	210,61	120,00	26,21	131,06	178,51	210,61
				20	0,91	81,77	295,09	120,00	41,55	194,51	255,54	295,09
				25	0,91	103,05	350,43	120,00	74,72	257,63	313,76	350,43
				30	0,91	124,33	389,04	120,00	128,76	307,45	359,45	389,04
3	1100	9		5	0,91	17,93	49,45	120,00	10,47	49,45	49,45	49,45
				10	0,91	39,21	114,95	120,00	17,26	82,45	99,51	114,95
				15	0,91	60,49	193,74	120,00	26,01	126,18	166,73	193,74
				20	0,91	81,77	270,45	120,00	40,72	183,19	236,88	270,45
				25	0,91	103,05	322,62	120,00	70,47	239,32	288,62	322,62
				30	0,91	124,33	358,62	120,00	117,19	285,40	329,77	358,62

¹⁾ Momentum degree of fullness without contribution from channel dead weight

²⁾ Size of designated system's single load

³⁾ dimensions in mm



Symbols and designation see Annex D1

Hilti MT installation channels MT-40D, MT-50, MT-70 and MT-80

Bending characteristics of Hilti MT channels in case of fire

Annex D17

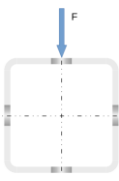
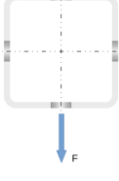
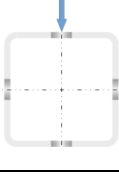
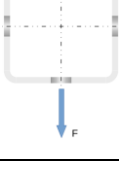
Table D18: Calculation-based deformation in case of fire for installation channels MT-70 S OC and MT-70 OC

System			Load direction	σ_B	$V^{1)}$	$F^{2)}$	$\delta_{t_{max};B}$	$t_{max,B}$	δ_{30}	δ_{60}	δ_{90}	δ_{120}
Loadcase	$L^{3)}$	n		MPa	-	N	mm	min	mm	mm	mm	mm
1	1400	-		5	0,50	67,92	54,74	120,00	11,73	54,74	54,74	54,74
				10	0,50	159,12	142,09	120,00	20,02	96,57	123,77	142,09
				15	0,50	250,32	245,97	120,00	30,50	147,49	207,15	245,97
				20	0,50	341,52	355,17	120,00	46,11	217,35	301,21	355,17
				25	0,50	432,72	441,62	120,00	74,90	293,35	384,18	441,62
				30	0,50	523,92	518,66	120,00	125,26	361,86	453,77	518,66
1	1400	-		5	0,50	67,92	54,85	120,00	11,79	54,85	54,85	54,85
				10	0,50	159,12	141,66	120,00	20,19	96,74	123,69	141,66
				15	0,50	250,32	241,24	120,00	30,76	146,97	204,90	241,24
				20	0,50	341,52	346,34	120,00	46,31	215,08	296,28	346,34
				25	0,50	432,72	424,05	120,00	74,09	288,31	373,15	424,05
				30	0,50	523,92	484,16	120,00	121,76	353,68	437,07	484,16
2	1400	-		5	0,67	237,72	78,46	120,00	14,30	70,84	78,29	78,46
				10	0,67	556,92	227,82	120,00	28,54	141,73	196,03	227,82
				15	0,67	876,12	314,93	120,00	49,05	233,09	288,77	314,93
				20	0,67	1195,32	377,06	120,00	92,91	305,91	353,78	377,06
				25	0,67	1514,52	410,55	120,00	177,30	354,16	392,80	410,55
				30	0,67	1833,72	419,50	102,67	241,32	388,45	415,60	-
2	1400	-		5	0,67	237,72	71,32	120,00	14,20	68,54	71,32	71,32
				10	0,67	556,92	187,55	120,00	27,75	128,14	166,28	187,55
				15	0,67	876,12	255,33	120,00	45,48	189,49	229,68	255,33
				20	0,67	1195,32	296,37	120,00	76,79	247,30	280,33	296,37
				25	0,67	1514,52	320,84	120,00	127,33	287,74	312,36	320,84
				30	0,67	1833,72	330,23	91,17	178,19	315,43	329,56	-
3	1400	12		5	0,93	9,70	61,83	120,00	12,96	61,83	61,83	61,83
				10	0,93	22,73	180,34	120,00	23,85	114,95	154,70	180,34
				15	0,93	35,76	285,87	120,00	38,00	182,92	249,05	285,87
				20	0,93	48,79	381,63	120,00	62,04	263,59	339,37	381,63
				25	0,93	61,82	446,39	120,00	111,17	335,73	403,85	446,39
				30	0,93	74,85	490,85	120,00	183,11	393,90	453,15	490,85
3	1400	12		5	0,93	9,70	61,63	120,00	12,96	61,63	61,63	61,63
				10	0,93	22,73	174,43	120,00	23,80	113,57	150,82	174,43
				15	0,93	35,76	270,16	120,00	37,76	177,01	237,14	270,16
				20	0,93	48,79	358,58	120,00	60,93	252,16	320,95	358,58
				25	0,93	61,82	420,09	120,00	105,68	317,90	381,99	420,09
				30	0,93	74,85	463,10	120,00	170,07	372,41	426,98	463,10

¹⁾ Momentum degree of fullness without contribution from channel dead weight

²⁾ Size of designated system's single load

³⁾ dimensions in mm



Symbols and designation see Annex D1

Hilti MT installation channels MT-40D, MT-50, MT-70 and MT-80

Bending characteristics of Hilti MT channels in case of fire

Annex D18

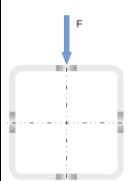
Table D19: Calculation-based deformation in case of fire for installation channels MT-70 S OC and MT-70 OC

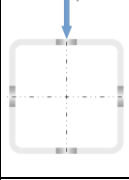
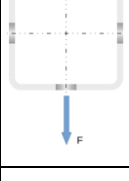
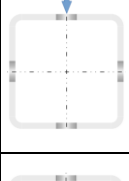
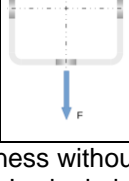
System			Load direction	σ_B	$V^{1)}$	$F^{2)}$	$\delta_{t_{max};B}$	$t_{max,B}$	δ_{30}	δ_{60}	δ_{90}	δ_{120}
Loadcase	$L^{3)}$	n		MPa	-	N	mm	min	mm	mm	mm	mm
1	1700	-		5	0,50	46,84	69,94	120,00	14,60	68,64	69,94	69,94
				10	0,50	121,94	204,84	120,00	26,85	129,43	178,09	204,84
				15	0,50	197,05	328,64	120,00	42,31	199,97	282,63	328,64
				20	0,50	272,16	449,22	120,00	65,25	288,58	390,65	449,22
				25	0,50	347,26	538,95	120,00	106,73	376,39	479,49	538,95
				30	0,50	422,37	614,38	120,00	175,02	452,62	553,18	614,38
1	1700	-		5	0,50	46,84	69,89	120,00	14,64	68,66	69,89	69,89
				10	0,50	121,94	204,21	120,00	26,94	129,39	177,78	204,21
				15	0,50	197,05	325,06	120,00	42,44	199,21	280,66	325,06
				20	0,50	272,16	442,39	120,00	65,22	286,64	386,88	442,39
				25	0,50	347,26	529,51	120,00	105,59	372,33	471,65	529,51
				30	0,50	422,37	592,73	120,00	171,58	447,06	541,47	592,73
2	1700	-		5	0,67	199,06	109,90	120,00	17,78	88,73	108,26	109,90
				10	0,67	518,26	303,22	120,00	38,71	189,58	264,87	303,22
				15	0,67	837,46	401,53	120,00	69,02	299,93	367,24	401,53
				20	0,67	1156,66	466,63	120,00	132,09	384,16	440,74	466,63
				25	0,67	1475,86	507,07	120,00	236,40	438,46	485,68	507,07
				30	0,67	1795,06	518,54	105,72	307,91	474,73	511,91	-
2	1700	-		5	0,67	199,06	98,73	120,00	17,63	85,46	98,73	98,73
				10	0,67	518,26	251,34	120,00	37,44	169,29	224,87	251,34
				15	0,67	837,46	330,79	120,00	63,23	243,87	300,24	330,79
				20	0,67	1156,66	376,42	120,00	107,01	311,08	351,88	376,42
				25	0,67	1475,86	401,45	120,00	169,95	356,87	388,11	401,45
				30	0,67	1795,06	408,28	94,69	230,59	388,17	407,08	-
3	1700	15		5	0,94	5,53	86,08	120,00	16,16	77,60	86,08	86,08
				10	0,94	14,40	250,27	120,00	32,25	154,14	216,36	250,27
				15	0,94	23,26	369,34	120,00	53,18	243,65	327,36	369,34
				20	0,94	32,13	473,79	120,00	88,56	340,78	428,77	473,79
				25	0,94	41,00	546,64	120,00	157,03	420,45	501,97	546,64
				30	0,94	49,86	597,20	120,00	246,32	485,67	554,77	597,20
3	1700	15		5	0,94	5,53	85,23	120,00	16,15	77,31	85,23	85,23
				10	0,94	14,40	243,38	120,00	32,14	152,23	211,60	243,38
				15	0,94	23,26	354,74	120,00	52,77	236,62	315,20	354,74
				20	0,94	32,13	451,39	120,00	86,89	328,37	410,16	451,39
				25	0,94	41,00	520,79	120,00	149,86	402,53	479,92	520,79
				30	0,94	49,86	569,71	120,00	231,67	464,05	530,59	569,71

¹⁾ Momentum degree of fullness without contribution from channel dead weight

²⁾ Size of designated system's single load

³⁾ dimensions in mm



Symbols and designation see Annex D1

Hilti MT installation channels MT-40D, MT-50, MT-70 and MT-80

Bending characteristics of Hilti MT channels in case of fire

Annex D19

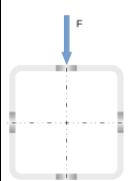
Table D20: Calculation-based deformation in case of fire for installation channels MT-70 S OC and MT-70 OC

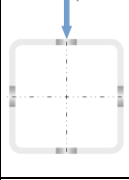
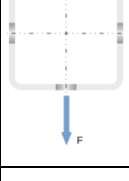
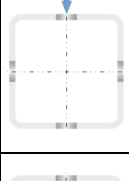
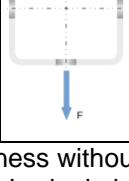
System			Load direction	σ_B	$V^{(1)}$	$F^{(2)}$	$\delta_{t_{max};B}$	$t_{max,B}$	δ_{30}	δ_{60}	δ_{90}	δ_{120}
Loadcase	$L^{(3)}$	n		MPa	-	N	mm	min	mm	mm	mm	mm
1	2000	-		5	0,50	30,58	99,99	120,00	18,35	86,97	99,99	99,99
				10	0,50	94,42	277,12	120,00	35,40	169,60	241,74	277,12
				15	0,50	158,26	417,36	120,00	56,88	260,37	364,62	417,36
				20	0,50	222,10	546,67	120,00	88,66	366,19	484,33	546,67
				25	0,50	285,94	644,10	120,00	144,85	463,89	579,38	644,10
				30	0,50	349,78	717,60	120,00	231,73	547,96	657,26	717,60
1	2000	-		5	0,50	30,58	99,86	120,00	18,36	86,93	99,86	99,86
				10	0,50	94,42	276,38	120,00	35,43	169,40	241,26	276,38
				15	0,50	158,26	414,68	120,00	56,89	259,45	362,91	414,68
				20	0,50	222,10	541,40	120,00	88,43	364,44	481,24	541,40
				25	0,50	285,94	636,96	120,00	143,42	460,56	574,24	636,96
				30	0,50	349,78	706,05	120,00	228,32	543,49	648,44	706,05
2	2000	-		5	0,67	152,92	142,95	120,00	21,71	108,34	139,97	142,95
				10	0,67	472,12	380,79	120,00	50,55	241,64	336,23	380,79
				15	0,67	791,32	493,91	120,00	92,41	368,74	448,30	493,91
				20	0,67	1110,52	559,08	120,00	175,95	464,18	530,48	559,08
				25	0,67	1429,72	603,59	120,00	297,78	525,98	581,32	603,59
				30	0,67	1748,92	621,31	110,18	377,74	566,21	611,58	-
2	2000	-		5	0,67	152,92	130,08	120,00	21,55	104,58	129,38	130,08
				10	0,67	472,12	320,01	120,00	48,73	215,12	288,09	320,01
				15	0,67	791,32	410,89	120,00	83,92	302,36	375,57	410,89
				20	0,67	1110,52	461,69	120,00	141,12	378,54	429,59	461,69
				25	0,67	1429,72	489,49	120,00	215,65	429,74	467,18	489,49
				30	0,67	1748,92	492,54	99,12	285,81	464,59	489,30	-
3	2000	18		5	0,95	3,06	117,05	120,00	19,99	96,34	116,61	117,05
				10	0,95	9,44	323,90	120,00	42,11	198,53	282,73	323,90
				15	0,95	15,83	456,93	120,00	70,87	307,58	407,78	456,93
				20	0,95	22,21	565,98	120,00	118,62	418,93	518,14	565,98
				25	0,95	28,59	646,13	120,00	205,08	505,78	599,47	646,13
				30	0,95	34,98	702,80	120,00	309,33	577,22	658,49	702,80
3	2000	18		5	0,95	3,06	116,03	120,00	19,98	96,04	115,76	116,03
				10	0,95	9,44	316,78	120,00	41,99	196,33	277,64	316,78
				15	0,95	15,83	444,49	120,00	70,38	300,16	396,15	444,49
				20	0,95	22,21	545,12	120,00	116,55	406,31	500,28	545,12
				25	0,95	28,59	621,64	120,00	196,92	489,01	578,10	621,64
				30	0,95	34,98	676,52	120,00	294,36	556,41	635,14	676,52

¹⁾ Momentum degree of fullness without contribution from channel dead weight

²⁾ Size of designated system's single load

³⁾ dimensions in mm

Symbols and designation see Annex D1

Hilti MT installation channels MT-40D, MT-50, MT-70 and MT-80

Bending characteristics of Hilti MT channels in case of fire

Annex D20

Table D21: Calculation-based deformation in case of fire for installation channels MT-80 S OC and MT-80 OC

System			Load direction	σ_B	$V^{1)}$	$F^{2)}$	$\delta_{t_{max};B}$	$t_{max,B}$	δ_{30}	δ_{60}	δ_{90}	δ_{120}
Loadcase	$L^{3)}$	n		MPa	-	N	mm	min	mm	mm	mm	mm
1	500	-		5	0,50	695,64	33,01	120,00	3,91	30,49	30,49	33,01
				10	0,50	1402,76	50,48	120,00	4,84	33,95	37,76	50,48
				15	0,50	2109,88	45,66	70,00	6,15	39,48	-	-
				20	0,50	2817,00	32,97	46,67	8,58	-	-	-
				25	0,50	3524,12	12,65	26,67	-	-	-	-
				30	0,50	4231,24	5,59	20,00	-	-	-	-
1	500	-		5	0,50	382,28	33,62	120,00	4,06	31,01	31,01	33,62
				10	0,50	776,04	47,93	120,00	5,26	35,86	40,97	47,93
				15	0,50	1169,80	83,59	120,00	6,89	42,92	58,57	83,59
				20	0,50	1563,56	166,18	120,00	9,55	54,26	102,55	166,18
				25	0,50	1957,32	196,80	120,00	14,50	74,38	162,61	196,80
				30	0,50	2351,08	213,12	120,00	24,49	128,76	188,32	213,12
2	500	-		5	0,67	869,55	37,31	120,00	4,50	32,31	33,44	37,31
				10	0,67	1753,45	47,60	80,00	6,22	38,77	-	-
				15	0,67	2637,35	35,52	48,33	9,35	-	-	-
				20	0,67	3521,25	22,29	30,00	22,29	-	-	-
				25	0,67	4405,15	14,87	21,67	-	-	-	-
				30	0,67	5289,05	7,96	18,33	-	-	-	-
2	500	-		5	0,67	477,85	37,91	120,00	4,87	33,34	34,55	37,91
				10	0,67	970,05	59,61	120,00	6,90	40,77	49,86	59,61
				15	0,67	1462,25	92,47	120,00	10,00	51,18	71,92	92,47
				20	0,67	1954,45	125,08	120,00	14,78	66,66	99,64	125,08
				25	0,67	2446,65	145,57	120,00	22,73	85,89	122,61	145,57
				30	0,67	2938,85	157,86	120,00	35,77	104,68	138,40	157,86
3	500	3		5	0,80	289,85	34,53	120,00	4,24	31,42	31,47	34,53
				10	0,80	584,48	49,08	120,00	5,42	35,90	41,32	49,08
				15	0,80	879,12	55,15	78,33	7,09	42,91	-	-
				20	0,80	1173,75	48,14	55,00	9,69	-	-	-
				25	0,80	1468,38	34,51	40,00	14,38	-	-	-
				30	0,80	1763,02	23,40	28,33	-	-	-	-
3	500	3		5	0,80	159,28	35,97	120,00	4,61	32,55	32,94	35,97
				10	0,80	323,35	53,63	120,00	6,31	38,76	45,94	53,63
				15	0,80	487,42	89,12	120,00	8,53	47,23	66,05	89,12
				20	0,80	651,48	153,84	120,00	11,72	60,54	99,99	153,84
				25	0,80	815,55	189,53	120,00	16,84	81,27	150,90	189,53
				30	0,80	979,62	209,16	120,00	25,74	111,49	180,91	209,16

¹⁾ Momentum degree of fullness without contribution from channel dead weight

²⁾ Size of designated system's single load

³⁾ dimensions in mm

Symbols and designation see Annex D1

Hilti MT installation channels MT-40D, MT-50, MT-70 and MT-80

Bending characteristics of Hilti MT channels in case of fire

Annex D21

Table D22: Calculation-based deformation in case of fire for installation channels MT-80 S OC and MT-80 OC

System			Load direction	σ_B	$V^{1)}$	$F^{2)}$	$\delta_{t_{max};B}$	$t_{max,B}$	δ_{30}	δ_{60}	δ_{90}	δ_{120}
Loadcase	$L^{3)}$	n		MPa	-	N	mm	min	mm	mm	mm	mm
1	900	-		5	0,50	372,18	38,41	120,00	5,01	34,19	35,16	38,41
				10	0,50	765,03	62,99	120,00	7,48	43,31	53,95	62,99
				15	0,50	1157,87	96,15	95,00	10,55	55,06	87,24	-
				20	0,50	1550,72	100,05	68,33	14,79	74,99	-	-
				25	0,50	1943,56	73,57	48,33	21,83	-	-	-
				30	0,50	2336,41	43,88	30,00	43,88	-	-	-
1	900	-		5	0,50	198,10	41,58	120,00	5,97	36,76	38,35	41,58
				10	0,50	416,85	72,90	120,00	9,71	49,38	63,00	72,90
				15	0,50	635,61	133,11	120,00	14,01	64,46	98,39	133,11
				20	0,50	854,36	267,87	120,00	19,39	87,31	158,89	267,87
				25	0,50	1073,12	347,89	120,00	27,13	121,99	267,63	347,89
				30	0,50	1291,87	380,84	120,00	40,86	184,85	336,11	380,84
2	900	-		5	0,67	837,42	48,42	120,00	6,39	38,70	44,35	48,42
				10	0,67	1721,32	66,96	70,00	10,40	55,05	-	-
				15	0,67	2605,22	45,18	41,67	17,10	-	-	-
				20	0,67	3489,12	27,43	28,33	-	-	-	-
				25	0,67	4373,02	19,41	21,67	-	-	-	-
				30	0,67	5256,92	11,67	18,33	-	-	-	-
2	900	-		5	0,67	445,72	50,58	120,00	7,73	41,73	46,94	50,58
				10	0,67	937,92	98,64	120,00	13,24	60,94	84,16	98,64
				15	0,67	1430,12	146,26	120,00	20,95	82,99	121,73	146,26
				20	0,67	1922,32	181,70	120,00	31,11	111,00	158,99	181,70
				25	0,67	2414,52	207,74	120,00	44,91	138,12	187,90	207,74
				30	0,67	2906,72	222,06	120,00	62,64	161,27	204,55	222,06
3	900	7		5	0,89	83,74	41,91	120,00	5,68	36,24	38,79	41,91
				10	0,89	172,13	73,67	120,00	8,68	47,62	62,54	73,67
				15	0,89	260,52	89,81	80,00	12,68	63,50	-	-
				20	0,89	348,91	80,90	56,67	17,95	-	-	-
				25	0,89	437,30	63,43	41,67	26,29	-	-	-
				30	0,89	525,69	51,85	31,67	41,51	-	-	-
3	900	7		5	0,89	44,57	46,58	120,00	7,02	39,74	43,22	46,58
				10	0,89	93,79	87,63	120,00	11,88	56,25	75,43	87,63
				15	0,89	143,01	147,23	120,00	17,94	75,70	115,14	147,23
				20	0,89	192,23	230,52	120,00	25,64	102,55	169,76	230,52
				25	0,89	241,45	303,99	120,00	36,37	137,46	232,77	303,99
				30	0,89	290,67	349,64	120,00	52,31	179,76	291,60	349,64

¹⁾ Momentum degree of fullness without contribution from channel dead weight

²⁾ Size of designated system's single load

³⁾ dimensions in mm



Symbols and designation see Annex D1

Hilti MT installation channels MT-40D, MT-50, MT-70 and MT-80

Bending characteristics of Hilti MT channels in case of fire

Annex D22

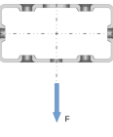
Table D23: Calculation-based deformation in case of fire for installation channels MT-80 S OC and MT-80 OC

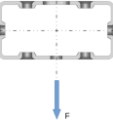
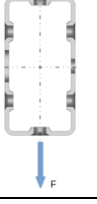
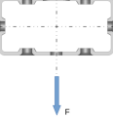
System			Load direction	σ_B	$V^1)$	$F^2)$	$\delta_{t_{max},B}$	$t_{max,B}$	δ_{30}	δ_{60}	δ_{90}	δ_{120}
Loadcase	$L^3)$	n		MPa	-	N	mm	min	mm	mm	mm	mm
1	1300	-		5	0,50	242,13	48,00	120,00	6,89	40,54	44,63	48,00
				10	0,50	514,10	93,62	120,00	11,70	58,34	80,65	93,62
				15	0,50	786,07	182,71	105,00	17,63	80,59	136,98	-
				20	0,50	1058,03	170,61	71,67	25,37	115,22	-	-
				25	0,50	1330,00	146,32	53,33	36,74	-	-	-
				30	0,50	1601,97	116,13	38,33	57,23	-	-	-
1	1300	-		5	0,50	121,60	55,00	120,00	9,06	45,88	51,29	55,00
				10	0,50	273,05	110,47	120,00	16,58	70,40	97,16	110,47
				15	0,50	424,50	191,47	120,00	25,26	97,19	148,91	191,47
				20	0,50	575,94	349,22	120,00	35,81	131,23	234,63	349,22
				25	0,50	727,39	481,09	120,00	49,14	177,04	354,21	481,09
				30	0,50	878,83	542,78	120,00	66,96	253,28	464,02	542,78
2	1300	-		5	0,67	786,91	66,81	120,00	9,38	48,96	62,36	66,81
				10	0,67	1670,81	92,03	63,33	17,16	83,42	-	-
				15	0,67	2554,71	57,77	36,67	29,96	-	-	-
				20	0,67	3438,61	31,31	26,67	-	-	-	-
				25	0,67	4322,51	16,66	20,00	-	-	-	-
				30	0,67	5206,41	17,81	18,33	-	-	-	-
2	1300	-		5	0,67	395,21	68,02	120,00	11,77	53,30	63,88	68,02
				10	0,67	887,41	150,59	120,00	22,44	89,05	130,10	150,59
				15	0,67	1379,61	224,65	120,00	36,85	127,11	189,90	224,65
				20	0,67	1871,81	277,82	120,00	54,93	169,19	241,90	277,82
				25	0,67	2364,01	312,83	120,00	77,30	209,95	286,49	312,83
				30	0,67	2856,21	336,03	120,00	103,18	244,03	317,92	336,03
3	1300	11		5	0,92	37,47	55,11	120,00	8,10	44,38	51,70	55,11
				10	0,92	79,56	118,64	120,00	14,04	67,09	98,97	118,64
				15	0,92	121,65	227,10	81,67	22,06	99,30	-	-
				20	0,92	163,74	165,27	58,33	32,63	-	-	-
				25	0,92	205,83	145,36	43,33	49,41	-	-	-
				30	0,92	247,92	107,85	31,67	81,90	-	-	-
3	1300	11		5	0,92	18,82	63,47	120,00	10,91	50,93	59,51	63,47
				10	0,92	42,26	137,34	120,00	20,46	82,23	118,36	137,34
				15	0,92	65,70	225,20	120,00	32,26	117,06	182,86	225,20
				20	0,92	89,13	327,58	120,00	46,92	161,79	258,81	327,58
				25	0,92	112,57	414,57	120,00	66,30	213,35	333,03	414,57
				30	0,92	136,01	479,56	120,00	93,02	267,96	401,27	479,56

¹⁾ Momentum degree of fullness without contribution from channel dead weight

²⁾ Size of designated system's single load

³⁾ dimensions in mm



Symbols and designation see Annex D1

Hilti MT installation channels MT-40D, MT-50, MT-70 and MT-80

Bending characteristics of Hilti MT channels in case of fire

Annex D23

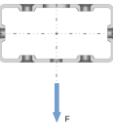
Table D24: Calculation-based deformation in case of fire for installation channels MT-80 S OC and MT-80 OC

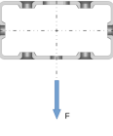
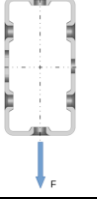
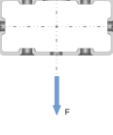
System			Load direction	σ_B	$V^1)$	$F^2)$	$\delta_{t_{max},B}$	$t_{max,B}$	δ_{30}	δ_{60}	δ_{90}	δ_{120}
Loadcase	$L^3)$	n		MPa	-	N	mm	min	mm	mm	mm	mm
1	1700	-		5	0,50	168,95	62,44	120,00	9,66	49,82	58,75	62,44
				10	0,50	376,93	136,59	120,00	17,59	79,31	117,83	136,59
				15	0,50	584,91	269,94	105,00	27,46	115,47	206,03	-
				20	0,50	792,88	260,64	71,67	39,97	170,27	-	-
				25	0,50	1000,86	250,27	55,00	57,92	-	-	-
				30	0,50	1208,83	185,75	40,00	86,70	-	-	-
1	1700	-		5	0,50	76,79	74,67	120,00	13,61	58,99	70,21	74,67
				10	0,50	192,60	163,74	120,00	26,10	98,74	143,60	163,74
				15	0,50	308,41	268,90	120,00	40,58	141,54	221,80	268,90
				20	0,50	424,22	400,99	120,00	58,11	193,51	313,55	400,99
				25	0,50	540,03	552,73	120,00	80,02	254,05	412,05	552,73
				30	0,50	655,85	639,97	120,00	108,54	320,86	535,96	639,97
2	1700	-		5	0,67	718,05	92,79	120,00	13,45	63,16	87,66	92,79
				10	0,67	1601,95	131,09	60,00	26,60	131,09	-	-
				15	0,67	2485,85	76,15	33,33	48,44	-	-	-
				20	0,67	3369,75	35,67	25,00	-	-	-	-
				25	0,67	4253,65	24,91	20,00	-	-	-	-
				30	0,67	5137,55	26,85	18,33	-	-	-	-
2	1700	-		5	0,67	326,35	89,58	120,00	16,82	67,55	84,64	89,58
				10	0,67	818,55	212,46	120,00	34,24	123,48	184,75	212,46
				15	0,67	1310,75	317,02	120,00	57,17	180,56	270,07	317,02
				20	0,67	1802,95	391,17	120,00	85,25	237,59	338,87	391,17
				25	0,67	2295,15	441,73	120,00	118,23	293,09	397,10	441,73
				30	0,67	2787,35	473,10	120,00	154,02	339,46	439,80	473,10
3	1700	15		5	0,94	19,95	73,56	120,00	11,49	55,67	69,72	73,56
				10	0,94	44,50	176,48	120,00	21,36	93,42	147,01	176,48
				15	0,94	69,05	744,33	120,00	34,81	145,87	436,38	744,33
				20	0,94	93,60	802,13	120,00	52,43	282,52	764,75	802,13
				25	0,94	118,16	392,10	46,67	80,08	-	-	-
				30	0,94	142,71	169,01	31,67	130,63	-	-	-
3	1700	15		5	0,94	9,07	85,70	120,00	16,14	65,59	80,89	85,70
				10	0,94	22,74	197,60	120,00	31,68	114,89	171,05	197,60
				15	0,94	36,41	315,56	120,00	50,73	167,78	261,79	315,56
				20	0,94	50,08	433,69	120,00	74,13	230,93	357,41	433,69
				25	0,94	63,75	533,46	120,00	103,95	298,66	445,25	533,46
				30	0,94	77,43	607,61	120,00	142,80	366,38	520,21	607,61

¹⁾ Momentum degree of fullness without contribution from channel dead weight

²⁾ Size of designated system's single load

³⁾ dimensions in mm



Symbols and designation see Annex D1

Hilti MT installation channels MT-40D, MT-50, MT-70 and MT-80

Bending characteristics of Hilti MT channels in case of fire

Annex D24

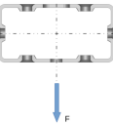
Table D25: Calculation-based deformation in case of fire for installation channels MT-80 S OC and MT-80 OC

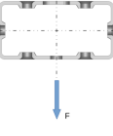
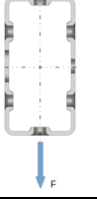
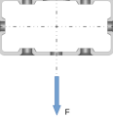
System			Load direction	σ_B	$V^1)$	$F^2)$	$\delta_{tmax;B}$	$t_{max;B}$	δ_{30}	δ_{60}	δ_{90}	δ_{120}
Loadcase	$L^3)$	n		MPa	-	N	mm	min	mm	mm	mm	mm
1	2100	-		5	0,50	120,16	83,18	120,00	13,57	62,85	79,02	83,18
				10	0,50	288,52	193,72	120,00	25,42	107,14	167,11	193,72
				15	0,50	456,88	432,28	103,33	40,38	160,91	301,21	-
				20	0,50	625,24	454,54	71,67	59,13	242,29	-	-
				25	0,50	793,60	335,47	53,33	85,54	-	-	-
				30	0,50	961,97	271,62	40,00	126,41	-	-	-
1	2100	-		5	0,50	45,55	101,80	120,00	19,93	76,75	96,25	101,80
				10	0,50	139,30	229,82	120,00	38,54	134,63	201,42	229,82
				15	0,50	233,05	368,17	120,00	60,14	195,86	307,61	368,17
				20	0,50	326,80	519,87	120,00	86,18	267,21	421,96	519,87
				25	0,50	420,56	660,20	120,00	118,30	345,93	534,50	660,20
				30	0,50	514,31	785,76	120,00	159,04	428,46	643,89	785,76
2	2100	-		5	0,67	630,82	125,99	120,00	18,61	81,22	119,80	125,99
				10	0,67	1514,72	165,38	56,67	38,79	-	-	-
				15	0,67	2398,62	106,50	31,67	73,38	-	-	-
				20	0,67	3282,52	54,07	25,00	-	-	-	-
				25	0,67	4166,42	35,86	20,00	-	-	-	-
				30	0,67	5050,32	24,72	16,67	-	-	-	-
2	2100	-		5	0,67	239,12	115,35	120,00	22,89	84,53	109,37	115,35
				10	0,67	731,32	284,17	120,00	48,45	163,56	247,68	284,17
				15	0,67	1223,52	421,52	120,00	81,50	242,04	360,67	421,52
				20	0,67	1715,72	515,33	120,00	121,55	315,26	448,60	515,33
				25	0,67	2207,92	577,86	120,00	166,77	386,33	517,77	577,86
				30	0,67	2700,12	617,24	120,00	213,99	444,99	569,82	617,24
3	2100	19		5	0,95	11,47	98,15	120,00	16,00	70,61	93,75	98,15
				10	0,95	27,54	248,72	120,00	30,85	127,22	207,64	248,72
				15	0,95	43,61	783,34	120,00	51,22	204,64	527,36	783,34
				20	0,95	59,68	949,12	120,00	77,86	400,37	857,93	949,12
				25	0,95	75,75	993,65	120,00	119,18	799,47	960,24	993,65
				30	0,95	91,82	258,19	31,67	193,61	-	-	-
3	2100	19		5	0,95	4,35	114,10	120,00	22,88	84,18	108,11	114,10
				10	0,95	13,30	268,38	120,00	45,75	154,39	233,47	268,38
				15	0,95	22,25	417,27	120,00	73,52	227,60	351,66	417,27
				20	0,95	31,19	548,65	120,00	107,21	309,42	465,17	548,65
				25	0,95	40,14	659,76	120,00	148,89	393,45	566,36	659,76
				30	0,95	49,09	741,32	120,00	200,63	473,38	648,91	741,32

¹⁾ Momentum degree of fullness without contribution from channel dead weight

²⁾ Size of designated system's single load

³⁾ dimensions in mm



Symbols and designation see Annex D1

Hilti MT installation channels MT-40D, MT-50, MT-70 and MT-80

Bending characteristics of Hilti MT channels in case of fire

Annex D25

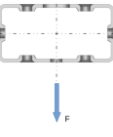
Table D26: Calculation-based deformation in case of fire for installation channels MT-80 S OC and MT-80 OC

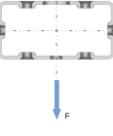
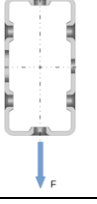
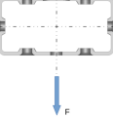
System			Load direction	σ_B	$V^1)$	$F^2)$	$\delta_{t_{max};B}$	$t_{max,B}$	δ_{30}	δ_{60}	δ_{90}	δ_{120}
Loadcase	$L^3)$	n		MPa	-	N	mm	min	mm	mm	mm	mm
1	2500	-		5	0,50	84,04	111,94	120,00	18,91	80,51	107,14	111,94
				10	0,50	225,46	266,28	120,00	35,47	142,67	229,51	266,28
				15	0,50	366,88	802,33	110,00	56,71	217,73	444,31	-
				20	0,50	508,31	773,69	75,00	83,20	335,07	-	-
				25	0,50	649,73	553,35	53,33	120,18	-	-	-
				30	0,50	791,16	357,60	38,33	176,40	-	-	-
1	2500	-		5	0,50	21,36	138,02	120,00	28,38	100,04	130,94	138,02
				10	0,50	100,12	308,53	120,00	54,19	178,52	270,72	308,53
				15	0,50	178,87	479,18	120,00	84,29	260,12	405,06	479,18
				20	0,50	257,62	648,90	120,00	120,30	351,28	540,54	648,90
				25	0,50	336,37	799,48	120,00	164,15	447,94	668,01	799,48
				30	0,50	415,12	920,41	120,00	218,40	545,27	783,93	920,41
2	2500	-		5	0,67	525,22	167,24	120,00	25,23	104,23	159,69	167,24
				10	0,67	1409,12	232,67	56,67	54,14	-	-	-
				15	0,67	2293,02	104,86	30,00	104,86	-	-	-
				20	0,67	3176,92	74,04	25,00	-	-	-	-
				25	0,67	4060,82	49,16	20,00	-	-	-	-
				30	0,67	4944,72	33,95	16,67	-	-	-	-
2	2500	-		5	0,67	133,52	145,36	120,00	30,03	104,44	138,15	145,36
				10	0,67	625,72	364,93	120,00	64,95	208,49	318,19	364,93
				15	0,67	1117,92	537,66	120,00	109,40	310,87	461,33	537,66
				20	0,67	1610,12	651,27	120,00	163,48	401,99	569,29	651,27
				25	0,67	2102,32	724,49	120,00	222,40	489,01	648,80	724,49
				30	0,67	2594,52	770,14	120,00	282,41	560,63	708,64	770,14
3	2500	23		5	0,96	6,73	129,65	120,00	21,75	89,60	124,51	129,65
				10	0,96	18,07	334,26	120,00	42,67	168,76	280,38	334,26
				15	0,96	29,40	832,28	120,00	71,46	275,19	646,73	832,28
				20	0,96	40,73	1062,42	120,00	109,03	529,85	903,31	1062,42
				25	0,96	52,06	1146,38	120,00	166,63	807,77	1085,21	1146,38
				30	0,96	63,39	1202,27	120,00	271,92	1102,39	1176,33	1202,27
3	2500	23		5	0,96	1,71	149,31	120,00	31,32	107,01	141,74	149,31
				10	0,96	8,02	348,26	120,00	62,61	200,36	304,42	348,26
				15	0,96	14,33	527,60	120,00	100,39	295,27	450,39	527,60
				20	0,96	20,64	672,83	120,00	145,71	395,98	581,12	672,83
				25	0,96	26,95	792,97	120,00	200,13	496,13	694,65	792,97
				30	0,96	33,26	881,96	120,00	265,20	587,86	785,50	881,96

¹⁾ Momentum degree of fullness without contribution from channel dead weight

²⁾ Size of designated system's single load

³⁾ dimensions in mm

Symbols and designation see Annex D1

Hilti MT installation channels MT-40D, MT-50, MT-70 and MT-80

Bending characteristics of Hilti MT channels in case of fire

Annex D26



PIPE CLAMPS WITH EUROPEAN TECHNICAL ASSESSMENT

**Fire Resistant Solutions for
Pipe Fixation - EN**

Version 1.3

02.2023



CONTENT

1. Load capacities Light duty Pipe Clamps	
1.1 MP-L-I	<u>Page 3</u>
1.2 MP-HI	<u>Page 4</u>
1.3 MP-H	<u>Page 5</u>
2. Load capacities Ultimate Pipe Clamps	
2.1 MP-U-I	<u>Page 6</u>
2.2 MP-U	<u>Page 7</u>
2.3 MP-U-G	<u>Page 8</u>
3. Load capacities Heavy duty Pipe Clamps	
3.1 MP-MI	<u>Page 9</u>
3.2 MP-MIS	<u>Page 10</u>
3.3 MP-M	<u>Page 11</u>
4. Maximum Spacing	
4.1 MP-L-I / MP-HI / MP-H	<u>Page 12</u>
4.2 MP-U-I	<u>Page 13</u>
4.3 MP-U	<u>Page 14</u>
4.4 MP-U-G – Pipe tables	<u>Page 15</u>
4.5 MP-MI / MP-MIS / MP-M	<u>Page 16</u>

MP-L-I

Premium galvanized pipe clamp with quick closure for economical light-duty applications



ETA-18/0570



Clamping range [mm] [inch]	M8	M8/10	Max. load capacity [N]			
			F _{rec} at ambient temp.	in case of fire*		
				30min	60min**	90min**
10 - 14 1/4"	2179331	2172815	400	140	100	90
15 - 20 3/8"	2179332	2172816				
20 - 26 1/2"	2179333	2172817				
26 - 32 3/4"	2179334	2172818				
32 - 38 1"	2179335	2172819				
38 - 45 1-1/4"	2179336	2172920	800	248	240	190
45 - 53 1-1/2"	2179337	2172921				
54 - 63 2"	2179338	2172922				
63 - 72	-	2172923				
73 - 82 2-1/2"	-	2172924				
83 - 92 3"	-	2172925	1.400	360	280	240
93 - 103	-	2172926				
104 - 114 4"	-	2172927				
115 - 128	-	2172928				
129 - 142 5"	-	2172929				
143 - 156	-	2172930	1.400	360	280	240
157 - 170 6"	-	2172931				

Link(s) to ETA document(s)

- [DE](#)
- [EN](#)

All approval details and the full scope of application must be taken from the respective ETA

* Not applicable to M8 single connection head (not part of the ETA / Report)
 ** FWD 60 & 90 not part of ETA but with an IBMB-Report

[Back to content page](#)

MP-HI

Premium galvanized pipe clamp with quick closure for light-duty applications



ETA-21/0803



Clamping range [mm] [inch]		M8 M8/10		Max. load capacity [N]			
				F _{rec} at ambient temp.	in case of fire		
					30min	60min	90min
8 - 12		-	386402	600	204	128	103
12 - 16	1/4"	-	386403				
16 - 20	3/8"	-	386404				
20 - 25	1/2"	-	386405				
25 - 31	3/4"	-	386406				
31 - 38	1"	-	386407	750	261	181	155
38 - 45	1-1/4"	-	386408				
45 - 52	1-1/2"	-	386409				
52 - 59		-	386410				
59 - 66	2"	-	386411				
66 - 75		-	386412	1.400	443	327	288
75 - 84	2-1/2"	-	386413				
84 - 93	3"	-	386414				
93 - 101		-	386415				
101 - 110		-	386416				
110 - 119	4"	-	386417	1.800	518	373	324
119 - 129		-	386418				
129 - 137		-	386419				
137 - 145	5"	-	386420				
145 - 155		-	386421				
155 - 163		-	386422				
163 - 172	6"	-	386423				

Link(s) to ETA document(s)

DE, EN, FR

All approval details and the full scope of application must be taken from the respective ETA

Back to content page

MP-H

Standard galvanized pipe clamp without sound inlay for light-duty applications



ETA-21/0803



Clamping range [mm] [inch]		M8	M8/10	F _{rec} at ambient temp.	Max. load capacity [N] in case of fire		
					30min	60min	90min
16 - 20	3/8"	-	386424	600	204	128	103
20 - 25	1/2"	-	386425				
25 - 31	3/4"	-	386426				
31 - 38	1"	-	386427				
38 - 45	1-1/4"	-	386428	750	261	181	155
45 - 52	1-1/2"	-	386429				
52 - 59		-	386430				
59 - 66	2"	-	386431				
66 - 74		-	386432	1.400	443	327	288
74 - 83	2-1/2"	-	386433				
83 - 92	3"	-	386434				
92 - 101		-	386435				
101 - 110		-	386436	1.800	518	373	324
110 - 119	4"	-	386437				
119 - 127		-	386438				
127 - 137		-	386439				
137 - 145	5"	-	386440	1.800	518	373	324
145 - 155		-	386441				
155 - 163		-	386442				
163 - 172	6"	-	386443				

Link(s) to ETA document(s)

DE, EN, FR

All approval details and the full scope of application must be taken from the respective ETA

[Back to content page](#)

MP-U-I

Ultimate galvanized pipe clamp with sound insulation inlay and quick closure for maximum productivity in medium-duty applications

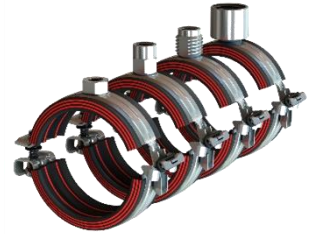

ETA-20/0952



Clamping range [mm] [inch]	Max. load capacity [N]		Max. load capacity [N]			Max. load capacity [N]		Max. load capacity [N]				
	M8	M8/10	F _{rec} at ambient temp.	in case of fire*			M8/10/1/2"	M8/10/O16	F _{rec} at ambient temp.	in case of fire		
				30min	60min	90min				30min	60min	90min
9 - 13 1/8"	2242237	2242258	800	215	137	111	2242283	2242308	800	184	121	100
13 - 17 1/4"	2242238	2242259					2242284	2242309				
17 - 21 3/8"	2242239	2242260					2242285	2242310				
21 - 25 1/2"	2242250	2242261					2242286	2242311				
25 - 29 3/4"	2242251	2242262					2242287	2242312				
29 - 33	2242252	2242263					2242288	2242313				
33 - 37 1"	2242253	2242264					2242289	2242314				
37 - 42	2242254	2242265					2242290	2242315				
42 - 47 1 1/4"	2242255	2242266					2242291	2242316				
47 - 52 1 1/2"	2242256	2242267					2242292	2242317				
52 - 57	2305363	2242268	2242293	2242318	1.400	689	392	293	1.400	570	333	253
57 - 62 2"	2305364	2242269	2242294	2242319								
62 - 67	-	2242270	2242295	2242320								
67 - 72	-	2242271	2242296	2242321								
72 - 77 2 1/2"	-	2242272	2242297	2242322								
78 - 84	-	2242273	2242298	2242323								
84 - 90 3"	-	2242274	2242299	2242324								
90 - 96	-	2242275	2242300	2242325								
97 - 103	-	2242276	2242301	2242326								
103 - 109	-	2242277	2242302	2242327								
109 - 115 4"	-	2242278	2242303	2242328	1.800	912	497	358	1.800	746	414	303
115 - 121	-	2242279	2242304	2242329								
122 - 128	-	2242280	2242305	2242330								
129 - 135	-	2242281	2242306	2242331								
135 - 141 5"	-	2305365	2242307	2242332								
141 - 147	-	2305366	2305371	2305377								
147 - 153	-	2305367	2305372	2305378								
154 - 160	-	2305368	2305373	2305379								
160 - 166 6"	-	2305369	2305374	2305380								
164 - 170	-	2305370	2305375	2305381								
			2305376	2305382	2.400	993	563	419	2.400	821	477	362

Link(s) to ETA document(s)

DE, EN, FR

All approval details and the full scope of application must be taken from the respective ETA

* Fire resistance not applicable to M8 connection head - ETA for M8 only valid at ambient temperature

Back to content page

MP-U

Premium galvanized pipe clamp with quick closure for high productivity in medium-duty applications (no sound inlay)



ETA-20/0952



Clamping range [mm] [inch]		M8 M8/10		Max. load capacity [N]			M8/10/1/2" M8/10/O16		Max. load capacity [N]				
				F _{rec} at ambient temp.	in case of fire				F _{rec} at ambient temp.	in case of fire			
					30min	60min	90min				30min	60min	90min
13 - 17	1/4"	-	2242334	800	215	137	111	2242359	-	800	184	121	100
16 - 20	3/8"	-	2242335					2242360	-				
20 - 24	1/2"	-	2242336					2242361	-				
25 - 29	3/4"	-	2242337					2242362	-				
30 - 34	1"	-	2242338					2242363	-				
34 - 38		-	2242339					2242364	-				
38 - 42		-	2242340					2242365	-				
42 - 47	1 1/4"	-	2242341					2242366	-				
47 - 52	1 1/2"	-	2242342					2242367	-				
52 - 57		-	2242343					2242368	-				
57 - 62	2"	-	2242344	2242369	-								
62 - 67		-	2242345	2242370	-								
67 - 72		-	2242346	2242371	-								
72 - 77	2 1/2"	-	2242347	2242372	-								
77 - 82		-	2242348	2242373	-								
83 - 89	3"	-	2242349	2242374	-								
89 - 95		-	2242350	2242375	-								
95 - 101		-	2242351	2242376	-								
102 - 108		-	2242352	2242377	-								
109 - 115	4"	-	2242353	2242378	-								
115 - 121		-	2242354	2242379	-								
121 - 127		-	2242355	2242380	-								
128 - 134		-	2242356	2242235	-								
135 - 141	5"	-	2242357	2242332	-								
141 - 147		-	2305351	2305357	-								
147 - 153		-	2305352	2305358	-								
153 - 159		-	2305353	2305359	-								
160 - 166	6"	-	2305354	2305360	-								
166 - 172		-	2305355	2305361	-								
170 - 176		-	2305356	2305362	-								

Link(s) to ETA document(s)

DE, EN, FR

All approval details and the full scope of application must be taken from the respective ETA

Back to content page

MP-U-G

Ultimate galvanized slide pipe clamp with low-friction inlay and quick closure for maximum productivity in medium-duty applications



ETA-20/0952



Diameter [mm] [inch]						Max. load capacity [N]			
						F _{rec} at ambient temp.	in case of fire		
		M8	M8/10	M8/10/1/2"	M8/10/O16	30min	60min	90min	
16		2275020	2275028	-	-	800	-	-	-
20		2275021	2275029	-	-		-	-	-
25		2275022	2275030	-	-		-	-	-
32		2275023	2275031	-	-		-	-	-
40		2275024	2275032	-	-		-	-	-
50		2275025	2275033	2275042	-	1.400	-	-	-
56		2275026	2275034	2275043	-		-	-	-
63		-	2275035	2275044	-		-	-	-
75		-	2275036	2275045	-	1.800	-	-	-
90		-	2275037	2275046	-		-	-	-
110		-	2275038	2275047	-	2.400	-	-	-
125		-	2275039	2275048	-		-	-	-
135		-	2275040	2275049	-		-	-	-
160		-	2275041	2274899	-	-	-	-	

Link(s) to ETA document(s)

DE, EN, FR

All approval details and the full scope of application must be taken from the respective ETA

* No fire resistance - ETA only valid at ambient temperature

[Back to content page](#)

MP-MI

Premium galvanized pipe clamp with sound inlay for heavy-duty piping applications



ETA-18/0130



Clamping range						F _{rec} at ambient temp.	Max. load capacity [N]			
[mm]	[inch]	M10/12	M16	1/2"	3/4"		in case of fire			
						30min	60min	90min	120min	
15 - 19	3/8"	20843	-	20844**	-	1.800	840	500	350	270
20 - 25	1/2"	20845	-	53132**	-					
25 - 30	3/4"	20847	-	53133**	-					
32 - 38	1"	20849	-	53134**	-					
40 - 45	1-1/4"	20851	-	53135**	-					
48 - 54	1-1/2"	20853	-	53136**	-					
54 - 57		20855	-	20856**	-					
57 - 64	2"	20857	20858*	53137**	-					
68 - 72		20860	-	20861**	-	1.800	850	560	430	350
70 - 77	2-1/2"	20862	20863*	-	53144**					
80 - 84		20865	-	-	-					
82 - 90	3"	20866	20867*	-	53149**					
97 - 103		20869	-	-	53150**	2.400	1.320	910	730	620
108 - 114	4"	20871	20872	-	53151**					
114 - 119		20874	-	-	20875**					
122 - 127		20876	-	-	20877**					
125 - 133		-	-	-	53164**					
132 - 137		20879	20880	-	20881**					
137 - 142	5"	20882	-	-	53165**					
150 - 156		-	-	-	20884**					
156 - 162		20885	229087	-	53168**	4.500	1.780	1.080	790	630
162 - 168	6"	20887	20888	-	53170**					
175 - 180		-	20890	-	20891**					
190 - 200		-	20892	-	53172**					
210 - 219		-	20894	-	20895**					
217 - 224	8"	-	20896	-	53174**					
242 - 250		-	20898	-	-					
267 - 273		-	20900*	-	53180**					

Link(s) to ETA document(s)

- DE
- EN

All approval details and the full scope of application must be taken from the respective ETA

* NOT part of ETA but Fire resistance approved/tested
 ** NOT part of ETA and NOT Fire resistance approved/tested

Back to content page

MP-MIS

Premium galvanized pipe clamp with high temperature resistance inlay for heavy-duty piping applications



No ETA



Clamping range						Max. load capacity [N]				
[mm]	[inch]	M10/12	M16	1/2"	3/4"	F _{rec} at ambient temp.	in case of fire			
							30min	60min	90min	120min
14 - 19	3/8"	47407*	-	-	-	1.800	850	700	430	350
20 - 25	1/2"	47408*	-	-	-					
25 - 30	3/4"	47409*	-	-	-					
32 - 38	1"	47410*	-	-	-					
40 - 45	1-1/4"	47411*	-	-	-					
48 - 54	1-1/2"	47412*	-	-	-					
54 - 57		47413*	-	-	-					
57 - 64	2"	47414*	-	-	-					
68 - 72		47415*	-	-	-					
70 - 77	2-1/2"	47400*	-	-	-					
78 - 84		47401*	-	-	-					
82 - 90	3"	47402*	-	-	-	2.400	1.320	910	730	620
97 - 103		47403*	-	-	-					
108 - 114	4"	47404*	-	-	-					
114 - 119		47405*	-	-	-					
122 - 127		47406*	-	-	-					
132 - 137		47416*	-	-	-					
137 - 142	5"	47417*	-	-	-	4.500	1.780	1.080	790	630
156 - 162		47418*	-	-	-					
162 - 168	6"	47419*	-	-	-					
175 - 180		-	47420*	-	-					
190 - 200		-	47421*	-	-					
210 - 219		-	47422*	-	-					
217 - 224	8"	-	47423*	-	-					
242 - 250		-	47424*	-	-					

All approval details and the full scope of application must be taken from the respective ETA

* NOT part of ETA but Fire resistance approved/tested
 ** NOT part of ETA and NOT Fire resistance approved/tested



[Back to content page](#)

MP-M

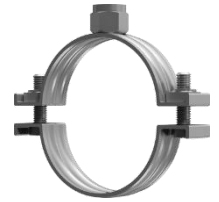
Standard galvanized pipe clamp without sound inlay for heavy-duty piping applications



No ETA

Clamping range [mm] [inch]		  				F _{rec} at ambient temp.	Max. load capacity [N]			
		M10/12	M16	1/2"	3/4"		in case of fire			
							30min	60min	90min	120min
15 - 19	3/8"	-	-	53181**	-	2.000	-	-	-	-
20 - 25	1/2"	-	-	53185**	-		-	-	-	-
25 - 30	3/4"	-	-	53190**	-		-	-	-	-
32 - 38	1"	-	-	53215**	-		-	-	-	-
40 - 45	1-1/4"	-	-	53216**	-		-	-	-	-
48 - 54	1-1/2"	-	-	53217**	-		-	-	-	-
57 - 64	2"	-	20909**	-	-		-	-	-	-
57 - 64	2"	-	-	53218**	-		-	-	-	-
70 - 77	2-1/2"	-	20911**	-	20913**		-	-	-	-
82 - 90	3"	-	20914**	-	53220**		-	-	-	-
97 - 103		-	-	-	53221**	3.000	-	-	-	-
108 - 114	4"	-	20917**	-	53223**		-	-	-	-
122 - 127		-	-	-	20920**		-	-	-	-
125 - 133		-	-	-	53224**		-	-	-	-
132 - 137		-	-	-	20922**		-	-	-	-
137 - 142	5"	-	20923**	-	53225**		-	-	-	-
150 - 156		-	-	-	20925**		-	-	-	-
156 - 162		-	-	-	53226**		-	-	-	-
162 - 168	6"	-	20927**	-	53228**		-	-	-	-
175 - 180		-	20929**	-	20930**		5.000	-	-	-
190 - 200		-	20931**	-	53229**	-		-	-	-
210 - 219		-	-	-	20933**	-		-	-	-
217 - 224	8"	-	20934**	-	53230**	-		-	-	-

All approval details and the full scope of application must be taken from the respective ETA

* NOT part of ETA but Fire resistance approved/tested
 ** NOT part of ETA and NOT Fire resistance approved/tested

[Back to content page](#)

Spacing distances for MP-L-I / -HI / -H

Below shown tables provide a calculated, theoretical maximum spacing based on a specific pipe type (material and standard). Any deviation or change in the pipe type or other parameters automatically leads to corresponding deviation in maximum spacing.

MP-L-I

ETA-18/0570



Clamping range [mm] [inch]		Pipe weight* OD [mm] [N/m]		F _{rec} at ambient temp.	Calculated max. spacing [m]**		
					in case of fire***		
					30min	60min	90min
10 - 14	1/4"	10,2	4,9	81,5	28,5	20,4	18,3
38 - 45	1-1/4"	42,4	44,1	9,1	3,2	2,3	2,0
45 - 53	1-1/2"	48,3	54,9	14,6	4,5	4,4	3,5
104 - 114	4"	114,3	237,4	3,4	1,0	1,0	0,8
115 - 128		127	284,5	4,9	1,3	1,0	0,8
157 - 170	6"	168,3	440,5	3,2	0,8	0,6	0,5

MP-HI

ETA-21/0803



Clamping range [mm] [inch]		Pipe weight* OD [mm] [N/m]		F _{rec} at ambient temp.	Calculated max. spacing [m]**		
					in case of fire		
					30min	60min	90min
8 - 12		10,2	4,9	122,3	41,5	26,2	21,0
31 - 38	1"	33,7	30,4	19,7	6,7	4,2	3,4
38 - 45	1-1/4"	42,4	44,1	17,0	5,9	4,1	3,5
59 - 66	2"	60,3	81,4	9,2	3,2	2,2	1,9
66 - 75		70	103,0	13,6	4,3	3,2	2,8
101 - 110		108	220,7	6,3	2,0	1,5	1,3
110 - 119	4"	114,3	237,4	7,6	2,2	1,6	1,4
163 - 172	6"	168,3	440,5	4,1	1,2	0,8	0,7

MP-H

ETA-21/0803



Clamping range [mm] [inch]		Pipe weight* OD [mm] [N/m]		F _{rec} at ambient temp.	Calculated max. spacing [m]**		
					in case of fire		
					30min	60min	90min
16 - 20	3/8"	17,2	9,8	61,2	20,8	13,1	10,5
38 - 45	1-1/4"	42,4	44,1	13,6	4,6	2,9	2,3
45 - 52	1-1/2"	48,3	54,9	13,7	4,8	3,3	2,8
66 - 74		70	103,0	7,3	2,5	1,8	1,5
74 - 83	2-1/2"	76,1	120,7	11,6	3,7	2,7	2,4
110 - 119	4"	114,3	237,4	5,9	1,9	1,4	1,2
119 - 127		127	284,5	6,3	1,8	1,3	1,1
163 - 172	6"	168,3	440,5	4,1	1,2	0,8	0,7

≥ 3,0m
< 3,0m - ≥ 1,5m
< 1,5m - ≥ 1,0m
< 1,0m

* Steel pipe (DIN EN10220) + Water + Insulation

** Max. spacing calculation not taking the allowed max. span of the pipe into account

*** Not applicable to M8 connection head (not part of the ETA / Report)

[Back to content page](#)

Spacing distances for MP-U-I

Below shown tables provide a calculated, theoretical maximum spacing based on a specific pipe type (material and standard). Any deviation or change in the pipe type or other parameters automatically leads to corresponding deviation in maximum spacing.

MP-U-I (M8 and M8/10)

ETA-20/0952



Clamping range		Pipe weight*		Calculated max. spacing [m]**				
				F _{rec} at ambient temp.	in case of fire***			
[mm]	[inch]	OD [mm]	[N/m]			30min	60min	90min
9 - 13	1/8"	10,2	4,9	163,1		43,8	27,9	22,6
33 - 37	1"	33,7	30,4	26,3		7,1	4,5	3,6
37 - 42		40	38,3	20,9		8,2	4,7	3,6
57 - 62	2"	60,3	81,4	9,8		3,9	2,2	1,7
62 - 67		63,5	86,3	16,2		8,0	4,5	3,4
90 - 96		88,9	165,8	8,4		4,2	2,4	1,8
97 - 103		101,6	204,0	8,8		4,5	2,4	1,8
135 - 141	5"	139,7	323,7	5,6		2,8	1,5	1,1
141 - 147		141,3	329,6	7,3		3,0	1,7	1,3
164 - 170		168,3	440,5	5,4		2,3	1,3	1,0

MP-U-I (M8/10/1/2" and M8/10/O16)

ETA-20/0952

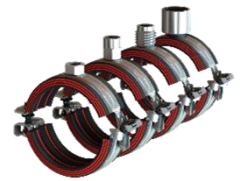

Clamping range		Pipe weight*		Calculated max. spacing [m]**				
				F _{rec} at ambient temp.	in case of fire			
[mm]	[inch]	OD [mm]	[N/m]			30min	60min	90min
9 - 13	1/8"	10,2	4,9	163,1		37,4	24,7	20,5
33 - 37	1"	33,7	30,4	26,3		6,0	4,0	3,3
37 - 42		40	38,3	20,9		6,8	4,1	3,1
57 - 62	2"	60,3	81,4	9,8		3,2	1,9	1,5
62 - 67		63,5	86,3	16,2		6,6	3,9	2,9
90 - 96		88,9	165,8	8,4		3,4	2,0	1,5
97 - 103		101,6	204,0	8,8		3,7	2,0	1,5
135 - 141	5"	139,7	323,7	5,6		2,3	1,3	0,9
141 - 147		141,3	329,6	7,3		2,5	1,4	1,1
164 - 170		168,3	440,5	5,4		1,9	1,1	0,8

* Steel pipe (DIN EN10220) + Water + Insulation

** Max. spacing calculation not taking the allowed max. span of the pipe into account

*** Fire resistance not applicable to M8 connection head - ETA for M8 only valid at ambient temperature

≥ 3,0m
< 3,0m - ≥ 1,5m
< 1,5m - ≥ 1,0m
< 1,0m

[Back to content page](#)

Spacing distances for MP-U

Below shown tables provide a calculated, theoretical maximum spacing based on a specific pipe type (material and standard). Any deviation or change in the pipe type or other parameters automatically leads to corresponding deviation in maximum spacing.

MP-U (M8/10)

ETA-20/0952



Clamping range [mm] [inch]		Pipe weight* OD [mm] [N/m]		F _{rec} at ambient temp.	Calculated max. spacing [m]**		
					in case of fire		
					30min	60min	90min
13 - 17	1/4"	13,5	7,8	101,9	27,3	17,4	14,1
38 - 42		40	38,3	20,9	5,6	3,6	2,9
42 - 47	1 ¼"	42,4	44,1	18,1	7,1	4,1	3,1
62 - 67		63,5	86,3	9,3	3,6	2,1	1,6
67 - 72		70	103,0	13,6	6,7	3,8	2,8
95 - 101		101,6	204,0	6,9	3,4	1,9	1,4
102 - 108		108	220,7	8,2	4,1	2,3	1,6
141 - 147		141,3	329,6	5,5	2,8	1,5	1,1
147 - 153		152,4	381,6	6,3	2,6	1,5	1,1
170 - 176		177,8	494,4	4,9	2,0	1,1	0,8

MP-U (M8/10/½")

ETA-20/0952



Clamping range [mm] [inch]		Pipe weight* OD [mm] [N/m]		F _{rec} at ambient temp.	Calculated max. spacing [m]**		
					in case of fire		
					30min	60min	90min
13 - 17	1/4"	13,5	7,8	101,9	23,4	15,4	12,8
38 - 42		40	38,3	20,9	4,8	3,2	2,6
42 - 47	1 ¼"	42,4	44,1	18,1	5,9	3,5	2,7
62 - 67		63,5	86,3	9,3	3,0	1,8	1,4
67 - 72		70	103,0	13,6	5,5	3,2	2,5
95 - 101		101,6	204,0	6,9	2,8	1,6	1,2
102 - 108		108	220,7	8,2	3,4	1,9	1,4
141 - 147		141,3	329,6	5,5	2,3	1,3	0,9
147 - 153		152,4	381,6	6,3	2,2	1,2	0,9
170 - 176		177,8	494,4	4,9	1,7	1,0	0,7

* Steel pipe (DIN EN10220) + Water + Insulation

** Max. spacing calculation not taking the allowed max. span of the pipe into account

≥ 3,0m
< 3,0m - ≥ 1,5m
< 1,5m - ≥ 1,0m
< 1,0m

[Back to content page](#)

Spacing distances of plastic pipes

The tables below show a selection of the plastic pipes and aluminum composite pipes available on the market and their maximum spacing regulated by either the manufacturer or a standard. Thus, the load values of the MP-U-G are far from being fully utilized.



NEW

ETA-20/0952



Wastewater pipes with increased sound insulation													
Diameter	Ke Kelit PhonEX AS	Geberit Silent-PP	Geberit Silent-Pro	Geberit Silent-db20 PP	Geberit Silent-db20 PP*	REHAU Raupiano	POLO-KAL NG	POLO-KAL 3S	Pipelife Master 3 Plus	Wavin AS	Max. spacing – all Pipes [m]		
	allowed max. spacing [m]												
	Horizontal												
32	-	0,50	-	-	-	0,48	0,50	-	0,45	-	0,50		
40	-	0,60	-	-	-	0,60	0,60	-	0,55	-	0,60		
50	-	0,75	0,75	-	-	0,75	0,75	-	0,65	0,75	0,75		
56	0,58	-	-	0,80	1,00	-	-	-	-	-	0,58		
63	-	-	-	-	-	-	-	-	-	-	-		
75	0,78	1,10	1,10	0,80	1,20	1,13	1,10	1,10	0,90	1,13	1,13		
90	-	1,35	1,35	0,90	1,40	1,35	1,35	1,35	-	1,35	1,35		
110	-	1,65	1,65	1,10	1,70	1,65	1,65	1,65	1,45	1,50	1,65		
125	-	1,85	1,85	-	-	1,88	1,85	1,85	1,65	1,63	1,88		
135	1,35	-	-	1,40	1,90	-	-	-	-	-	1,35		
160	1,60	2,40	2,40	1,70	2,40	2,40	2,40	2,40	2,10	2,00	2,40		

Diameter	Ke Kelit PhonEX AS	Geberit Silent-PP	Geberit Silent-Pro	Geberit Silent-db20 PP	REHAU Raupiano	POLO-KAL NG	POLO-KAL 3S	Pipelife Master 3 Plus	Wavin AS	Max. spacing – all Pipes [m]	
	allowed max. spacing [m]										
	Vertical										
32	-	1,5	-	-	1,5	1,5	-	1,5	-	1,50	
40	-	1,5	-	-	1,5	1,5	-	1,5	-	1,50	
50	-	1,5	1,5	-	1,5	1,5	-	1,5	1,3	1,50	
56	2,0	-	-	1,5	-	-	-	-	-	2,00	
63	-	-	-	-	-	-	-	-	-	-	
75	2,0	2,0	2,0	1,5	2,0	2,0	2,0	2,0	1,9	2,00	
90	-	2,0	2,0	1,5	2,0	2,0	2,0	-	2,0	2,00	
110	-	2,0	2,0	1,7	2,0	2,0	2,0	2,0	2,0	2,00	
125	-	2,0	2,0	-	2,0	2,0	2,0	2,0	2,0	2,00	
135	2,0	-	-	1,9	-	-	-	-	-	2,00	
160	2,0	2,0	2,0	2,4	2,0	2,0	2,0	2,0	2,0	2,40	

* w/ support tray

Plastic pipes							
Diameter	PVC-U (DIN 8062-3)	PE (DIN 8074 - SDR 17)	PP-SDR	PE 100 SDR-17	Geberit PE	Geberit PE (w/ support tray)	Max. spacing – all Pipes [m]
	allowed max. spacing [m]						
25	-	-	0,5	-	-	-	0,5
32	-	1,0	0,7	-	-	-	1,0
40	-	1,0	0,8	-	0,8	1,0	1,0
50	0,5	1,0	1,0	-	0,8	1,0	1,0
56	-	-	-	-	0,8	1,0	1,0
63	0,6	1,3	1,3	-	-	-	1,3
75	0,8	1,4	1,4	-	0,8	1,2	1,4
90	0,9	1,5	1,5	1,5	0,9	1,4	1,5
110	1,2	1,6	1,6	1,6	1,1	1,7	1,7
125	1,3	1,8	1,8	1,8	1,3	1,9	1,9
135	1,4	1,9	1,9	1,9	-	-	1,9
160	1,8	2,0	2,0	2,0	1,6	2,4	2,4

Al-composite pipes												
Diameter	Wavin Tigris	KeKelit Kelox	Uponor Uni Pipe Plus / MLC	Gerberit Mepla Verbundrohr +GF+	JRG Sanipex	Viega Raxofix	Roth Alu-Laserplus	TECE TECEflex	Rehau Rautitan flex	Rehau Rautitan stabil	Pipelife RADOPRESS	Max. spacing – all Pipes [m]
	allowed max. spacing [m]											
16	1,0	1,2	2,0	1,5	1,2	1,0	1,0	1,0	1,0	1,0	1,0	2,0
20	1,2	1,3	2,3	1,5	1,2	1,0	1,0	1,2	1,0	1,3	1,0	2,3
25	1,5	1,5	2,6	1,5	1,2	1,5	1,5	1,3	1,2	1,5	1,5	2,6
32	1,5	1,6	2,6	2,0	1,5	2,0	1,5	1,5	1,4	1,8	2,0	2,6
40	1,8	1,7	2,0	2,0	1,5	2,0	1,8	1,8	1,5	2,0	2,0	2,0
50	1,8	2,0	2,0	2,5	1,5	2,5	1,8	2,0	1,5	-	2,5	2,5
63	2,0	2,2	2,2	2,5	1,5	2,5	2,0	2,0	1,5	-	2,5	2,5
75	2,2	2,4	2,4	2,5	-	-	-	-	-	-	-	2,5
90	-	-	2,4	-	-	-	-	-	-	-	-	2,4
110	-	-	2,4	-	-	-	-	-	-	-	-	2,4

* No fire resistance - ETA only valid at ambient temperature

[Back to content page](#)

Spacing distances for MP-MI / -MIS / -M

Below shown tables provide a calculated, theoretical maximum spacing based on a specific pipe type (material and standard). Any deviation or change in the pipe type or other parameters automatically leads to corresponding deviation in maximum spacing.

MP-MI (M10/12, M16, 1/2", 3/4")

ETA-18/0130



Clamping range [mm] [inch]		Pipe weight* OD [mm] [N/m]		Calculated max. spacing [m]**				
				F _{rec} at ambient temp.	in case of fire***			
					30min	60min	90min	120min
15 - 19	3/8"	17,2	9,8	183,5	85,6	51,0	35,7	27,5
57 - 64	2"	60,3	81,4	22,1	10,3	6,1	4,3	3,3
68 - 72		70	103,0	17,5	8,3	5,4	4,2	3,4
82 - 90	3"	88,9	165,8	10,9	5,1	3,4	2,6	2,1
97 - 103		101,6	204,0	11,8	6,5	4,5	3,6	3,0
162 - 168	6"	168,3	440,5	5,4	3,0	2,1	1,7	1,4
175 - 180		177,8	494,4	9,1	3,6	2,2	1,6	1,3
267 - 273		273	1021,2	4,4	1,7	1,1	0,8	0,6

MP-MIS (M10/12, M16)

No ETA



Clamping range [mm] [inch]		Pipe weight* OD [mm] [N/m]		Calculated max. spacing [m]**				
				F _{rec} at ambient temp.	in case of fire			
					30min	60min	90min	120min
14 - 19	3/8"	17,2	9,8	183,5	86,6	71,4	43,8	35,7
82 - 90	3"	88,9	165,8	10,9	5,1	4,2	2,6	2,1
97 - 103		101,6	204,0	11,8	6,5	4,5	3,6	3,0
162 - 168	6"	168,3	440,5	5,4	3,0	2,1	1,7	1,4
175 - 180		177,8	494,4	9,1	3,6	2,2	1,6	1,3
242 - 250		244,5	862,3	5,2	2,1	1,3	0,9	0,7

MP-M (M16, 1/2", 3/4")

No ETA



Clamping range [mm] [inch]		Pipe weight* OD [mm] [N/m]		Calculated max. spacing [m]**				
				F _{rec} at ambient temp.	in case of fire			
					30min	60min	90min	120min
15 - 19	3/8"	17,2	9,8	203,9	n.a.	n.a.	n.a.	n.a.
82 - 90	3"	88,9	165,8	12,1	n.a.	n.a.	n.a.	n.a.
97 - 103		101,6	204,0	14,7	n.a.	n.a.	n.a.	n.a.
162 - 168	6"	168,3	440,5	6,8	n.a.	n.a.	n.a.	n.a.
175 - 180		177,8	494,4	10,1	n.a.	n.a.	n.a.	n.a.
217 - 224	8"	219,1	731,8	6,8	n.a.	n.a.	n.a.	n.a.

≥ 3,0m
< 3,0m - ≥ 1,5m
< 1,5m - ≥ 1,0m
< 1,0m

* Steel pipe (DIN EN10220) + Water + Insulation

** Max. spacing calculation not taking the allowed max. span of the pipe into account

*** Not applicable to 1/2" and 3/4" connection head (not part of the ETA / Report)

[Back to content page](#)